

Pilot's Guide

EFS 40/50

Bendix/King® 4-inch/5-inch
Electronic Flight
Instrumentation System



Honeywell

WARNING

The enclosed technical data is eligible for export under License Designation NLR and is to be used solely by the individual/organization to whom it is addressed. Diversion contrary to U.S. law is prohibited.

COPYRIGHT NOTICE

Copyright ©1996, 2005, 2008, 2010 Honeywell International Inc.
All rights reserved.

Reproduction of this publication or any portion thereof by any means without the express written permission of Honeywell International Inc. is prohibited. For further information contact the Manager, Technical Publications; Honeywell; One Technology Center; 23500 West 105th Street; Olathe, Kansas 66061. Telephone: (913) 712-0400.

This pilot's guide has been tailored by the installation and or certification agency to cover the following EFS 40/50 installation:

AIRCRAFT TYPE _____

AIRCRAFT TAIL OR SERIAL NUMBER _____

AIRCRAFT OWNER _____

EFIS TYPE (EFS 40 or EFS 50) _____

EFIS SYSTEM CONFIGURATION _____

EFIS SYSTEM SOFTWARE LEVEL _____

EFIS DISPLAY UNIT TYPE _____

EFIS CONTROL PANELS _____

REVERSIONARY MODES _____

Throughout this pilot's guide various configuration options are described. A 4o (check box) precedes each configuration option. A check mark may be placed in the appropriate boxes to define which configuration options are available in a given installation.

TABLE OF CONTENTS

Section I

INTRODUCTION	1.1
---------------------	-----

Section 1

SYSTEM CONFIGURATION	1.1
GENERAL	1.1
CONTROL PANEL	1.2
SYMBOL GENERATOR	1.3
EQUIPMENT INTERFACE & OPERATING CONFIGURATION	1.5
SOFTWARE 04 CONFIGURATION PAGES	1.6
SOFTWARE 05 CONFIGURATION PAGES	1.9
SOFTWARE 06 CONFIGURATION PAGES	1.12
SOFTWARE 07 CONFIGURATION PAGES	1.15
(includes both 0701 and 0702)	
SOFTWARE 08 CONFIGURATION PAGES	1.18
SOFTWARE 09 CONFIGURATION PAGES	1.21
SOFTWARE 10 CONFIGURATION PAGES	1.25
SOFTWARE 11 CONFIGURATION PAGES	1.29
SOFTWARE 12 CONFIGURATION PAGES	1.33
SOFTWARE 13 CONFIGURATION PAGES	1.37
SOFTWARE 14 CONFIGURATION PAGES	1.41
SOFTWARE 15 CONFIGURATION PAGES	1.45
SOFTWARE 16 CONFIGURATION PAGES	1.48

Section 2

EHSI OPERATION	2.1.1
DETAILED OPERATING CONTROLS	2.1.1
EHSI CONTROLS (ED 461 & CP 467/468)	2.1.1
1-2 NAVIGATION SYSTEM SELECT	2.1.3
NAV NAVIGATION SENSOR SELECT	2.1.3
HSI 360° MODE SELECTION	2.1.5
BEARING POINTER SELECT	2.1.6
ARC SECTORED MODE SELECTION	2.1.7
RANGE SELECTION	2.1.8
TST/REF	2.1.8
TST—	2.1.8
REF GROUND SPEED	
or TIME-TO-STATION selection	2.1.8
REF MAP FORMAT	2.1.9
COURSE SELECT KNOB	2.1.10
HEADING SELECT KNOB	2.1.10
DISPLAY BRIGHTNESS CONTROL	2.1.10

Table of Contents

EADI OPERATION	2.2.1
EADI DETAILED OPERATING CONTROLS	2.2.1
BRIGHTNESS	2.2.2
DH SET	2.2.2
RALT TST	2.2.2
RADAR OPERATION	2.3.1
RADAR CONTROLS, (CP 466A & CP 466B)	2.3.1
OFF-STBY-TST-ON	2.3.2
OFF	2.3.2
STBY	2.3.2
TST	2.3.2
ON	2.3.2
WX	2.3.2
WXA	2.3.2
GND MAP	2.3.2
LIGHTNING	2.3.3
VP	2.3.3
TRK	2.3.4
GAIN	2.3.5
PULL ARL	2.3.5
TILT	2.3.5
MFD OPERATION	2.4.1
MULTI FUNCTION DISPLAY CONTROL PANEL	2.4.1
CONTROL PANEL BUTTON OPERATIONS	2.4.2
COURSE SELECT KNOB/BUTTON	2.4.2
HSI BUTTON	2.4.2
ARC BUTTON	2.4.2
NAV BUTTON	2.4.2
1-2 BUTTON	2.4.3
BEARING #1 & #2 BUTTON	2.4.3
RANGE UP/DOWN BUTTON	2.4.3
JOYSTICK	2.4.3
WAYPOINT ENTRY OPERATION	2.4.3
PLAN VIEW OPERATION (available with 07 and higher)	2.4.4
CHECKLIST OPERATION(available with 08 and higher)	2.4.5
ENT BUTTON	2.4.5
WAYPOINT ENTRY OPERATION	2.4.5
PLAN VIEW OPERATION(available with 07 and higher)	2.4.5
CHECKLIST OPERATION(available with 08 and higher)	2.4.6
TEST/REFERENCE	2.4.6
CHECKLIST SELECT (available with 08 and higher)	2.4.6
TCAS ONLY SELECT (available with 08 and higher)	2.4.6

Section 3**ABBREVIATED OPERATIONS**

3.1

Section 4

EHSI DISPLAYS	4.1.1
EFS 40/50 COLOR STANDARDS	4.1.1
STANDARD EHSI DISPLAYS	4.1.1
NORMAL COMPASS CARD	4.1.1
NAVIGATION SOURCE ANNUNCIATION	4.1.2
SYMBOLIC AIRCRAFT	4.1.3
HEADING SELECT "BUG"	4.1.4
COURSE SELECT	4.1.4
LATERAL COURSE DEVIATION SCALE	4.1.5
LATERAL COURSE DEVIATION BAR	4.1.6
TO/FROM INDICATOR	4.1.6
DISTANCE, GROUND SPEED and TIME-TO-STATION	4.1.6
DUAL MULTICHANNEL DME INSTALLATIONS	4.1.7
DME HOLD	4.1.8
BEARING POINTER	4.1.9
MAGNETIC/TRUE HEADING ANNUNCIATIONS	4.1.11
RADIO ALTITUDE	4.1.11
GLIDE SLOPE/VERTICAL NAVIGATION	4.1.11
WIND VECTOR	4.1.13
DRIFT ANGLE POINTER (LNAV only)	4.1.13
LNAV MODE ANNUNCIATIONS	4.1.14
360 Map Displays	4.1.14
MAP 360 COMPASS CARD	4.1.15
SELECTED COURSE	4.1.15
MAP COURSE DEVIATION INDICATOR	4.1.16
TO/FROM	4.1.16
BEARING POINTER	4.1.16
REFERENCE WAYPOINT	4.1.16
RANGE RING	4.1.17
360-DEGREE MAP WX RADAR (IF EQUIPPED)	4.1.18
RDR 1400 WEATHER RADAR	4.1.19
LIGHTNING DETECTION	4.1.20
FULL TIME LNAV MAP	4.1.21
ARC (Expanded Sector Mode) Displays	4.1.22
HDG BUG (ALL ARC FORMAT MODES)	4.1.22
COURSE DEVIATION INDICATOR (EHSI ARC NON-MAP FORMAT)	4.1.22

Table of Contents

Custom (Non-Standard EHSI) Displays	4.1.23
DOPPLER	4.1.23
COMPASS CARD	4.1.23
DOPPLER VELOCITY BARS	4.1.23
VELOCITY AND TARGET SCALE	4.1.23
LNAV GROUND SPEED AND READOUT	4.1.24
WIND VECTOR INFORMATION	4.1.24
TARGET WAYPOINT	4.1.24
TENDENCY CIRCLE	4.1.24
MEMORY	4.1.24
HEADING BUG	4.1.24
CABLE	4.1.25
COMPASS CARD	4.1.25
ANGLE BARS	4.1.25
FUNNEL SCALE	4.1.25
WIND VECTOR INFORMATION	4.1.25
OPTIMUM CABLE POSITION CIRCLE	4.1.26
THRUST COMMAND	4.1.26
HEADING BUG	4.1.26
HOMING	4.1.26
LATERAL DEVIATION BAR	4.1.27
EADI DISPLAYS	4.2.1
NORMAL ATTITUDE DISPLAY	4.2.1
PITCH ATTITUDE	4.2.1
ROLL ATTITUDE	4.2.1
ROLL INDICATOR	4.2.2
Sky Pointer Roll Scale	4.2.2
Roll Indicator Scale	4.2.2
PERSPECTIVE LINES	4.2.2
SYMBOLIC AIRCRAFT	4.2.2
HEADING TAPE	4.2.3
FLIGHT DIRECTOR COMMAND BARS	4.2.3
AUTOPILOT/FLIGHT DIRECTOR MODE ANNUNCIATION	4.2.4
STANDARD 429 AUTOPILOT/FLIGHT	
DIRECTOR MODE ANNUNCIATION	4.2.4
SFIM CDV AUTOPILOT/FLIGHT	
DIRECTOR MODE ANNUNCIATION	4.2.7
RADIO ALTIMETER	4.2.8
DECISION HEIGHT SET	4.2.9
DECISION HEIGHT ALERT	4.2.9
PRECISION APPROACH MODE FORMAT	4.2.9
EXPANDED LATERAL DEVIATION SCALE	4.2.9
RISING RUNWAY	4.2.10
GLIDESLOPE/VERTICAL NAVIGATION	4.2.11

EADI OFF-SIDE ILS/MLS	4.2.11
MARKER BEACON ANNUNCIATION	4.2.12
FAST/SLOW OR COLLECTIVE DISPLAY	4.2.12
MACH DISPLAY	4.2.13
RATE OF TURN DISPLAY	4.2.13
CATEGORY II ANNUNCIATOR	4.2.14
CATEGORY II OPERATION ANNUNCIATIONS	4.2.14
DUAL EFS SYSTEM	4.2.14
SINGLE EFS SYSTEM	4.2.15
CATEGORY II THRESHOLDS	4.2.16
ATTITUDE MONITOR	4.2.17
CROSS COMPARATOR ANNUNCIATORS	4.2.17
RA	4.2.17
LOC	4.2.17
GS	4.2.17
ATT	4.2.17
HDG	4.2.18
COMPOSITE DISPLAYS	4.3.1
COMPOSITE MODE	4.3.1
HEADING TAPE	4.3.1
SELECTED COURSE	4.3.1
HEADING BUG SELECT	4.3.1
NAVIGATION SOURCE ANNUNCIATION	4.3.2
LATERAL COURSE DEVIATION SCALE	4.3.2
LATERAL COURSE DEVIATION BAR	4.3.2
TO/FROM	4.3.3
DISTANCE INFORMATION	4.3.3
DME HOLD	4.3.3
MFD DISPLAYS	4.4.1
CRS, NOT CRS SELECT	4.4.1
WEATHER ONLY	4.4.1
TRACK LINE	4.4.1
VERTICAL PROFILE (VP)	4.4.1
SYMBOLIC AIRCRAFT	4.4.1
RANGE RINGS	4.4.2
ALTITUDE LINE	4.4.2
PROFILE ANGLE	4.4.2
PLAN VIEW NORTH-UP MAP	4.4.2
CHECKLIST INTERFACE	4.4.3
LOADING AND MODIFYING CHECKLIST DATA	4.4.3
CHECKLIST PAGE ORGANIZATION	4.4.4
ROOT INDEX PAGE	4.4.4

Table of Contents

SUB INDEX PAGES	4.4.5
CHECKLIST ITEM PAGES	4.4.5
NOTE PAGES	4.4.6
CLEARING CHECKLIST ITEMS	4.4.6
EMERGENCY PAGE ACTIVATION	4.4.6
CHECKLIST CONTROLS	4.4.7
Checklist: CHKLIST	4.4.7
Joystick	4.4.7
Enter : ENT	4.4.8
HSI	4.4.9
ARC	4.4.9
NAV	4.4.9
Up Arrow	4.4.9
Down Arrow	4.4.9
1-2	4.4.9
RMI 1	4.4.10
RMI 2	4.4.10
CRS (NOT) SEL	4.4.10
TST REF	4.4.10
CRS Knob	4.4.10
REMOTELY MOUNTED SWITCHES	4.4.10
FAULT ANNUNCIATIONS	4.4.10
TCAS INTERFACE	4.4.11
TCAS ONLY SELECTION	4.4.11
TCAS DISPLAY FORMAT	4.4.12
TCAS TRAFFIC SYMBOLOGY	4.4.12
Intruder Symbols	4.4.12
Vertical Speed Arrow	4.4.12
Data Tag	4.4.12
Off-Scale Traffic	4.4.13
TCAS DISPLAY ANNUNCIATIONS	4.4.13
Traffic	4.4.13
TCAS	4.4.13
TCAS Status	4.4.14
TCAS Mode	4.4.14
Range	4.4.15
Above/Norm/Below	4.4.15
No-Bearing Traffic	4.4.15
FLXXX and FL	4.4.15
EGPWS INTERFACE	4.4.16
EGPWS SELECTION	4.4.16
EGPWS DISPLAY FORMAT	4.4.16
EGPWS MODE/STATUS	4.4.16
EGPWS RANGE	4.4.16

Section 5

OPERATING INSTRUCTIONS	5.1
PREFLIGHT PROCEDURES	5.1
START UP	5.1
SELF TEST	5.1
PUSH BUTTON TEST	5.1
PRE-TAKEOFF PROCEDURES	5.2
IN-FLIGHT OPERATION	5.2
ADF	5.2
LNAV (RNAV)	5.3
VNAV	5.3
APPROACH PROCEDURES	5.3
ILS APPROACH	5.3
BACK COURSE APPROACH	5.4
ADF APPROACH	5.4
LNAV (RNAV) APPROACH	5.4
VNAV GPS PRECISION APPROACH	5.4
VOR APPROACH	5.5
DECISION HEIGHT SELECTION	5.5
LIMITATIONS	5.5
EMERGENCY PROCEDURES	5.5

Section 6

FAULT ANNUNCIATIONS	6.1
GENERAL	6.1
EXTERNAL SYSTEM FAILURES	6.1
HEADING	6.1
ATTITUDE	6.1
FLIGHT DIRECTOR	6.1
EFS 40/50 SYSTEM FAILURES	6.1
DU—DISPLAY UNIT LOSS OF COOLING	6.1
SG—SYMBOL GENERATOR LOSS OF COOLING	6.1
CP—CONTROL PANEL (CP 467, CP 468, ED 461 OR CP 470)	6.2
HEADING SELECT “BUG”	6.2
COURSE SELECT	6.2
RCP—RADAR CONTROL PANEL (if equipped)	6.2
SG—SYMBOL GENERATOR	6.2
RAW DATA DEVIATION ANNUNCIATIONS	6.3
BEARING POINTER ANNUNCIATIONS	6.3
ALPHANUMERIC READOUT ANNUNCIATIONS	6.3
CHECK CONFIG	6.3

Table of Contents

WEATHER RADAR ANNUNCIATIONS	6.4
WX FLT	6.4
WX OFF	6.4
BUSY VP	6.4
RT FLT	6.4
STB LMT	6.4
TGTLRT	6.4
TGT	6.4
429 FLT	6.4
ANT FLT	6.5
TX FLT	6.5
RANGE	6.5
STB OFF	6.5
WAIT	6.5
CUSTOM DISPLAY FAILURE ANNUNCIATIONS	6.5
DOPPLER/CABLE	6.5
EXTERNAL SYSTEM FAILURES	6.5
FMS Warning	6.5
Autopilot Warning	6.5
TCAS FAULT MESSAGES	6.6
Fault Messages for TCAS Fail	6.6
Fault Messages for No TCAS	6.6
LIGHTNING DETECTION DISPLAY FAULT MESSAGES	6.6

Section 7

REVERSIONARY MODES	7.1
CMPST - COMPOSITE	7.2
COPY OFF-SIDE	7.3
DISPLAY (EADI) DOWN	7.4
STBY - STANDBY	7.5
REVERSIONARY MODE SELECTION	7.6
THREE TUBE EFS 40/50	7.6
FOUR TUBE EFS 40/50	7.7
FIVE TUBE EFS 40	7.8
FIVE TUBE EFS 50	7.9

Section 8

GLOSSARY	8.1
ABBREVIATIONS	8.1

Section 9

INDEX	9.1
--------------	-----

INTRODUCTION

This pilot's guide describes the components, operation, and operational procedures of the BENDIX/KING EFS 40/50 Electronic Flight Instrumentation System (EFIS) containing system software 04, 05, 06, 07, 08, 09, 10, 11, 12, 13, 14, 15, and 16.

The EFS 40 system uses either a single control display unit, four inch ED 461, or a separate CP 467 mode controller and four inch ED 462 display unit for control and display of navigation data and sensor selection. When a Multi-Function Display is incorporated in the system, the CP 469/A will control and select navigation data for display on the MFD. A CP 466A or CP 466B

provides the radar control function when an RDS 81/82/84 or 86 weather radar is interfaced with the system, and the associated radar control/display unit is not installed.

The EFS 50 system uses a remote CP 467 mode controller and an ED 551/A display unit for control and display of navigation data and sensor selection. The remote SYMBOL GENERATOR, SG 464 or SG 465, interfaces with the navigation sensors to compute the display and EFIS output data required by other systems on board the aircraft. The SG 464 is no longer available and has not been produced with software versions 08 or later.

Equipment covered in this pilot's guide includes:

ED 461	Control display unit, 4" X 4"
ED 462	Display unit, 4" X 4"
SG 464	EHSI/MFD-only symbol generator (not available with software 08 or later)
SG 465	EFIS symbol generator
CP 466A	RDS 81/82/84 radar control panel
CP 466B	RDS 86 radar control panel
CP 467	EFIS control panel with DH set and test
CP 468	EFIS control panel, less DH set and test
CP 469	MFD control panel
CP 469A	MFD control panel with Checklist, TCAS and Joystick features
CP 470	EADI brightness and DH set and test panel
ED 551	Display unit, 5" X 5" (not available in current production)
ED 551A	Display unit, 5" X 5" (~16% larger symbols compared with ED 461/2 presentation)

An **Abbreviated Operations** section included in this manual covers the functions of the EFS 40/50 in minimal detail. The Abbreviated Operations section gives a brief visual overview of

features and push button operations. However, it is necessary to read the entire Pilot's Guide for a full understanding of the EFS 40/50 system.

Note: *The EFS 40/50 display illustrations used in this pilot's guide are artist's reproductions. Extreme care has been taken to ensure the accuracy of symbology placement and relative size. However, it is impossible to exactly duplicate the display of a CRT and compensate for all brightness levels, as line width displayed on the CRT varies with brightness. In many cases, unrealistic displays provide the most informative display possible on a single display. Therefore, we ask that you use and treat the graphic illustrations contained in this pilot's guide as they were intended. These*

illustrations are to familiarize the pilot with the type and placement of data to be provided by the EFS 40/50.

ED 551A is the only version in current production.

The data presented in this pilot's guide is general in nature and not tailored toward a specific installation. Not all equipment interfaces nor display options presented are certifiable in all aircraft types or by all certification agencies. Each installation may incorporate different equipment components and use different display options. For the unique certified operating procedure of a particular aircraft, refer to the appropriate approved Flight Manual Supplement for that aircraft.

SYSTEM CONFIGURATION

GENERAL

Various configurations of the EFS 40/50 system are currently available to fulfill the particular needs of the user. These configurations are differentiated by the number of display units, type of mode controller, number of symbol generators and the interfacing equipment.

The basic EFS 40 (2 tube four inch Electronic Flight Instrumentation System) consists of:

- 1ea EHSI Control/Display Unit (ED 461)
- 1 ea EADI Display Unit (ED 462)
- 1 ea EADI control panel (CP 470)
- 1 ea Symbol Generator (SG 465)
- Or 1 ea remote EFIS Control Panel (CP 467)
- 1 ea EHSI Display Unit (ED 462)
- 1 ea EADI Display Unit (ED 462)
- 1 ea Symbol Generator (SG 465)

The basic EFS 50 (2 tube five inch Electronic Flight Instrumentation System) consists of:

- 1 ea remote EFIS Control Panel (CP 467)

- 1 ea EHSI Display Unit (ED 551A),
- 1 ea EADI Display Unit (ED 551A)
- 1 ea Symbol Generator (SG 465)

Beginning with software 09, a configuration option was added allowing an MFD only installation. This option removes the heading bug from the display allowing the MFD SG to stand alone without any other symbol generator in the installation. The display unit in this case can be either an ED 462 or ED 551A. The control panel must be a CP 469A.

- o MFD ONLY - no selected heading bug.

Two new configuration options for display unit (DU) type were also added with software 09. These options allow the MFD SG to drive a 5" ED 551A MFD during normal operation and change to either ED 461 or ED 462 EHSI and ED 462 EADI during standby operation.

- o MFD - ED 551A
EHSI - ED 461
EADI - ED 462
- o MFD - ED 551A
EHSI - ED 462
EADI - ED 462



ED 551/A MFD & CP 469A



2 EA ED 462 & CP 467



2 EA ED 551A & CP 467



ED 461, ED 462, & CP 470

*Figure 1.1
CONTROL DISPLAY OPTIONS*

CONTROL PANEL

The ED 461 Control/Display Unit incorporates the EHSI mode controller in the bezel of the display, reducing the required panel space to 4" X 4". For those installations that are not sensitive to panel space, an independent display unit, ED 462, ED 551A, and mode controller, CP 467, are

offered. Figure 1.1 depicts the EFS 40/50 Control Display Options.

Regardless of which display unit and method of control is selected, the system's performance will be identical. Both mode controllers offer a simple means for the pilot to select the desired display format, such as standard

compass rose or sectored compass rose, 360-degree map or sectored map and weather radar overlay. Also incorporated on the mode controller is the course and heading select knobs with auto sync. The auto sync feature

will slew the heading bug to the lubber line or the course pointer to the DIRECT TO course for the selected NAV sensor providing a centered D-Bar. The CP 467 and CP 470 incorporate Decision Height Set and Radio Altimeter Test.

SYMBOL GENERATOR

The SG 464 EHSI/MFD-only symbol generator is a remote-mounted processing unit packaged in an ARINC 1/4 ATR short form factor. The SG 465 EADI/EHSI/MFD symbol generator is a remote-mounted processing unit packaged in an ARINC 3/8 ATR short form factor. A version of the SG 465 3/8 ATR short symbol generator is offered with EHSI/MFD-only provisions.

The SG 464 or SG 465 with software version 05 and above will drive either the 4" X 4" (ED 461 or 462) or 5" X 5" (ED 551A) displays. Software version 06 incorporates the capability to drive the ED 551 display. The SG 464 is no longer available and has not been produced with software versions 08 or later.

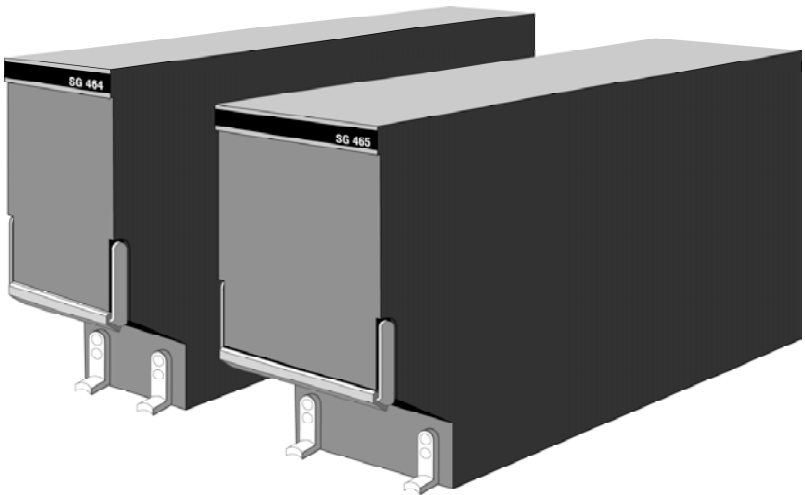

Figure 1.2
SG 464 AND SG 465 SYMBOL GENERATORS

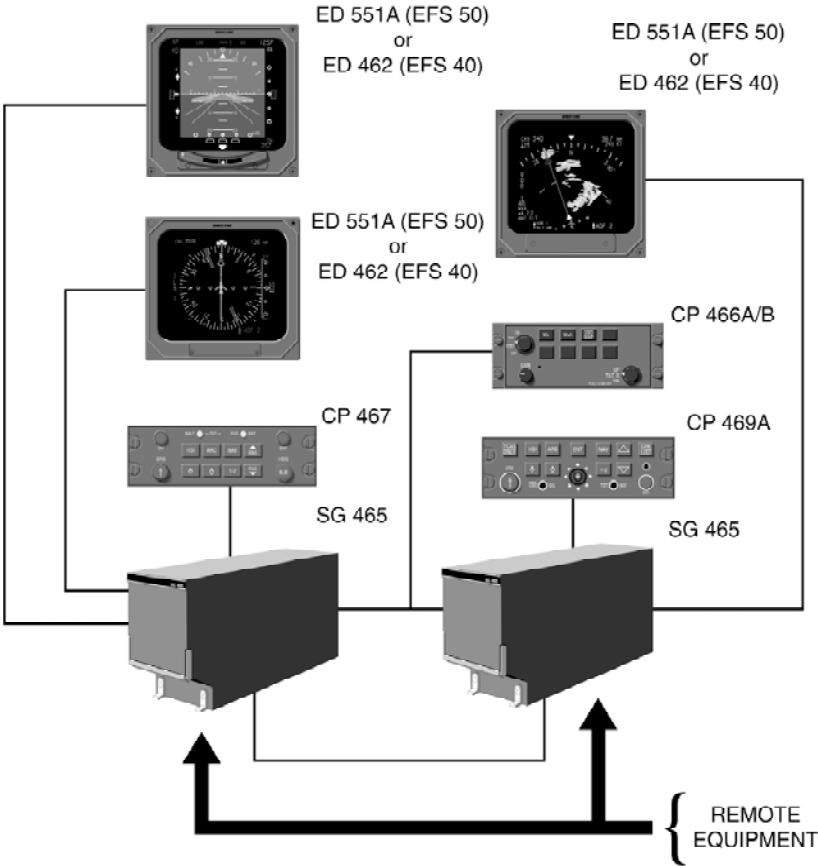

Figure 1.3
TYPICAL EFS 40/50 SYSTEM BLOCK DIAGRAM

EQUIPMENT INTERFACE & OPERATING CONFIGURATION

The EFS 40/50 equipment interface and operating configuration is established at the time of installation and certification. The following pages are provided to document the certified configura-

tion of a specific aircraft. Those pages referring to software configuration versions not applicable to this aircraft are to be removed from this pilot's guide.

SOFTWARE 04 CONFIGURATION PAGES

The EHSI, EADI, and Reversion software will display these pages. All items will be identical among all 3 displays, however, the ADI will not be able to show the rack configurations, instead it will show the configuration data coming from the HSI and the data in its own EEPROM. The descriptions given in this section refer to side 1 (left side) as the pilot's side and side 2 (right side) as the co-pilot's side.

1	VIEW/EDIT EQUIPMENT	PG 01
2	ITEM	
3	SG NUMBER	
4	SINGLE/DUAL	_____
5	DU TYPE	_____
6	ATTITUDE/HDG #1	_____
7	ATTITUDE/HDG #2	_____
8	RATE OF TURN	_____
9	ADF #1	_____
10	ADF #2	_____
11	VOR/ILS #1	_____
12	VOR/ILS #2	_____
13	..MORE..	

1	VIEW/EDIT EQUIPMENT	PG 02
2	ITEM	
3	DME #1	
4	DME #2	_____
5	MLS #1	_____
6	MLS #2	_____
7	FMS #1	_____
8	FMS #2	_____
9	RNAV #1	_____
10	RNAV #2	_____
11	TACAN #1	_____
12	TACAN #2	_____
13	..MORE..	

1 VIEW/EDIT EQUIPMENT PG 03
2 ITEM
3 VNAV
4 RADAR ALT
5 AFCS TYPE
6 AFCS COMMAND BAR
7 AFCS MODE ANN
8 AIR DATA
9 RADAR TYPE
10 RADAR CTL PNL
11 RADAR INDICATOR
12 CHECKLIST
13 ..MORE..

1 VIEW/EDIT EQUIPMENT PG 04
2 ITEM
3 JOYSTICK
4 RADAR GRAPHICS

1 VIEW/EDIT OPERATING CHAR PG 06
2 ITEM
3 VERT SCALE SIDE
4 DCLTR GS ON BC
5 SPARE
6 DISPLAY WIND VEC
7 DISPLAY DRIFT
8 DG ONLY MODE
9 DME DIST ONLY
10 RADAR ONLY MODE
11 HOVER MODE
12 ..MORE..

System Configuration

1	VIEW/EDIT OPERATING		PG 07
2	ITEM		
3	DISPLAY HDG TAPE	_____	
4	COMMAND BARS	_____	
5	ROLL INDICATOR	_____	
6	DCLTR UNUS ATT	_____	
7	CAT II AVAILABLE	_____	
8	PERSPECTIVE LINES	_____	
9	DH SELECT	_____	
10	CABLE MODE	_____	

SOFTWARE 05 CONFIGURATION PAGES

The EHSI, EADI, MFD and Reversion software will display the following pages. All display information will be identical on the EHSI and MFD, however, the EADI will not display the rack configurations, it will display a comparison of the EHSI and EADI configuration data. The descriptions given in this section refer to side 1 (left side) as the pilot's side and side 2 (right side) as the co-pilot's side.

1	VIEW/EDIT EQUIPMENT	PG 01
2	ITEM	
3	SG NUMBER	
4	SINGLE/DUAL	_____
5	DU TYPE	_____
6	ATTITUDE/HDG #1	_____
7	ATTITUDE/HDG #2	_____
8	RATE OF TURN	_____
9	ADF #1	_____
10	ADF #2	_____
11	VOR/ILS #1	_____
12	VOR/ILS #2	_____
13	..MORE..	

1	VIEW/EDIT EQUIPMENT	PG 02
2	ITEM	
3	DME #1	
4	DME #2	_____
5	MLS #1	_____
6	MLS #2	_____
7	FMS #1	_____
8	FMS #2	_____
9	RNAV #1	_____
10	RNAV #2	_____
11	TACAN #1	_____
12	TACAN #2	_____
13	..MORE..	

System Configuration

1	VIEW/EDIT EQUIPMENT	PG 03
2	ITEM	
3	VNAV	
4	RADAR ALT	_____
5	AFCS TYPE	_____
6	AFCS COMMAND BAR	_____
7	AFCS MODE ANN	_____
8	AIR DATA	_____
9	RADAR TYPE	_____
10	RADAR CTL PNL	_____
11	RADAR INDICATOR	_____
12	CHECKLIST	_____
13	..MORE..	

1	VIEW/EDIT EQUIPMENT	PG 04
2	ITEM	
3	JOYSTICK	_____
4	RADAR GRAPHICS	_____
5	HOMING #1	_____
6	HOMING #2	_____

1	VIEW/EDIT OPERATING CHAR	PG 06
2	ITEM	
3	VERT SCALE SIDE	_____
4	DCLTR GS ON BC	_____
5	FULL TIME FMS MAP	_____
6	DISPLAY WIND VEC	_____
7	DISPLAY DRIFT	_____
8	DG ONLY MODE	_____
9	DME DIST ONLY	_____
10	RADAR ONLY MODE	_____
11	HOVER MODE	_____
12	MFD NAV CONTROL	_____
13	..MORE..	

1	VIEW/EDIT OPERATING		PG 07
2	ITEM		
3	DISPLAY HDG TAPE	_____	
4	COMMAND BARS	_____	
5	ROLL INDICATOR	_____	
6	DCLTR UNUS ATT	_____	
7	CAT II AVAILABLE	_____	
8	PERSPECTIVE LINES	_____	
9	DH SELECT	_____	
10	CABLE MODE	_____	
11	SEL HDG SYNC	_____	
12	SEL CRS SYNC	_____	

SOFTWARE 06 CONFIGURATION PAGES

The EHSI, EADI, MFD and Reversion software will display the following pages. All display information will be identical on the EHSI and MFD, however, the EADI will not display the rack configurations, it will display a comparison of the EHSI and EADI configuration data. The descriptions given in this section refer to side 1 (left side) as the pilot's side and side 2 (right side) as the co-pilot's side.

1	VIEW/EDIT EQUIPMENT	PG 01
2	ITEM	
3	SG NUMBER	
4	SINGLE/DUAL	_____
5	DU TYPE	_____
6	ATTITUDE/HDG #1	_____
7	ATTITUDE/HDG #2	_____
8	RATE OF TURN	_____
9	ADF #1	_____
10	ADF #2	_____
11	VOR/ILS #1	_____
12	VOR/ILS #2	_____
13	..MORE..	

1	VIEW/EDIT EQUIPMENT	PG 02
2	ITEM	
3	DME #1	
4	DME #2	_____
5	MLS #1	_____
6	MLS #2	_____
7	FMS #1	_____
8	FMS #2	_____
9	RNAV #1	_____
10	RNAV #2	_____
11	TACAN #1	_____
12	TACAN #2	_____
13	..MORE..	

1	VIEW/EDIT EQUIPMENT		PG 03
2	ITEM		
3	VNAV		
4	RADAR ALT	_____	
5	AFCS TYPE	_____	
6	AFCS COMMAND BAR	_____	
7	AFCS MODE ANN	_____	
8	F/S AIR DATA	_____	
9	RADAR TYPE	_____	
10	RADAR CTL PNL	_____	
11	RADAR INDICATOR	_____	
12	CHECKLIST	_____	
13	..MORE..		

1	VIEW/EDIT EQUIPMENT		PG 04
2	ITEM		
3	JOYSTICK	_____	
4	TCAS	_____	
5	HOMING #1	_____	
6	HOMING #2	_____	
7	LIGHTNING DET	_____	

1	VIEW/EDIT OPERATING CHAR		PG 06
2	ITEM		
3	VERT SCALE SIDE	_____	
4	DCLTR GS ON BC	_____	
5	FULLTIME FMS MAP	_____	
6	DISPLAY WIND VEC	_____	
7	DISPLAY DRIFT	_____	
8	DG ONLY MODE	_____	
9	DME DIST ONLY	_____	
10	RADAR ONLY MODE	_____	
11	HOVER MODE	_____	
12	MFD NAV CONTROL	_____	
13	..MORE..		

System Configuration

1	VIEW/EDIT OPERATING		PG 07
2	ITEM		
3	DISPLAY HDG TAPE	_____	
4	COMMAND BARS	_____	
5	ROLL INDICATOR	_____	
6	DCLTR UNUS ATT	_____	
7	CAT II AVAILABLE	_____	
8	PERSPECTIVE LINES	_____	
9	DH SELECT	_____	
11	CABLE MODE	_____	
11	SEL HDG SYNC	_____	
12	SEL CRS SYNC	_____	
13	..MORE..		

1	VIEW/EDIT OPERATING		PG 08
2	ITEM		
3	NORTH UP MAP	_____	
4	VERT PTR TYPE	_____	
5	DISPLAY FMS MSG	_____	
6	SEL HDG COLOR	_____	
7	CMD BAR COLOR	_____	
8	REV MODE ANN	_____	
9	RISING RUNWAY	_____	
10	ADI DEV SRC	_____	
11	CMD BAR FILTER	_____	

**SOFTWARE 07 CONFIGURATION PAGES
(includes both 0701 and 0702)**

The EHSI, EADI, MFD and Reversion software will display the following pages. All display information will be identical on the EHSI and MFD, however, the EADI will not display the rack configurations, it will display a comparison of the EHSI and EADI configuration data. The descriptions given in this section refer to side 1 (left side) as the pilot's side and side 2 (right side) as the co-pilot's side.

1	VIEW/EDIT EQUIPMENT	PG 01
2	ITEM	
3	SG NUMBER	_____
4	SINGLE/DUAL	_____
5	DU TYPE	_____
6	ATTITUDE/HDG #1	_____
7	ATTITUDE/HDG #2	_____
8	RATE OF TURN	_____
9	ADF #1	_____
10	ADF #2	_____
11	VOR/ILS #1	_____
12	VOR/ILS #2	_____
13	..MORE..	

1	VIEW/EDIT EQUIPMENT	PG 02
2	ITEM	
3	DME #1	_____
4	DME #2	_____
5	MLS #1	_____
6	MLS #2	_____
7	FMS #1	_____
8	FMS #2	_____
9	RNAV #1	_____
10	RNAV #2	_____
11	TACAN #1	_____
12	TACAN #2	_____
13	..MORE..	

System Configuration

1	VIEW/EDIT EQUIPMENT	PG 03
2	ITEM	
3	VNAV	_____
4	RADAR ALT	_____
5	AFCS TYPE	_____
6	AFCS COMMAND BAR	_____
7	AFCS MODE ANN	_____
8	F/S AIR DATA	_____
9	RADAR TYPE	_____
10	RADAR CTL PNL	_____
11	RADAR INDICATOR	_____
12	CHECKLIST	_____
13	..MORE..	

1	VIEW/EDIT EQUIPMENT	PG 04
2	ITEM	
3	JOYSTICK	_____
4	TCAS	_____
5	HOMING #1	_____
6	HOMING #2	_____
7	LIGHTNING DET	_____
8	HOVER MODE	_____
9	CABLE MODE	_____

1	VIEW/EDIT OPERATING CHAR	PG 06
2	ITEM	
3	VERT SCALE SIDE	_____
4	DCLTR GS ON BC	_____
5	FULL TIME FMS MAP	_____
6	DISPLAY WIND VEC	_____
7	DISPLAY DRIFT	_____
8	DG ONLY MODE	_____
9	DME DIST ONLY	_____
10	RADAR ONLY MODE	_____
11	SPARE	_____
12	MFD NAV CONTROL	_____
13	..MORE..	

1	VIEW/EDIT OPERATING		PG 07
2	ITEM		
3	DISPLAY HDG TAPE	_____	
4	COMMAND BARS	_____	
5	ROLL INDICATOR	_____	
6	DCLTR UNUS ATT	_____	
7	CAT II AVAILABLE	_____	
8	PERSPECTIVE LINES	_____	
9	DH SELECT	_____	
10	CTL PNL SYNC	_____	
11	SEL HDG SYNC	_____	
12	SEL CRS SYNC	_____	
13	..MORE..		

1	VIEW/EDIT OPERATING		PG 08
2	ITEM		
3	NORTH UP MAP	_____	
4	VERT PTR TYPE	_____	
5	DISPLAY FMS MSG	_____	
6	SEL HDG COLOR	_____	
7	CMD BAR COLOR	_____	
8	REV MODE ANN	_____	
9	RISING RUNWAY	_____	
10	ADI DEV SRC	_____	
11	CMD BAR FILTER	_____	

SOFTWARE 08 CONFIGURATION PAGES

The EHSI, EADI, MFD and Reversion software will display the following pages. All display information will be identical on the EHSI and MFD, however, the EADI will not display the rack configurations, it will display a comparison of the EHSI and EADI configuration data. The descriptions given in this section refer to side 1 as the pilot's side and side 2 as the co-pilot's side.

1	VIEW/EDIT EQUIPMENT	PG 01
2	ITEM	
3	SG NUMBER	_____
4	SINGLE/DUAL	_____
5	DU TYPE	_____
6	ATTITUDE/HDG #1	_____
7	ATTITUDE/HDG #2	_____
8	RATE OF TURN	_____
9	ADF #1	_____
10	ADF #2	_____
11	VOR/ILS #1	_____
12	VOR/ILS #2	_____
13	..MORE..	

1	VIEW/EDIT EQUIPMENT	PG 02
2	ITEM	
3	DME #1	_____
4	DME #2	_____
5	MLS #1	_____
6	MLS #2	_____
7	FMS #1	_____
8	FMS #2	_____
9	RNAV #1	_____
10	RNAV #2	_____
11	TACAN #1	_____
12	TACAN #2	_____
13	..MORE..	

1 VIEW/EDIT EQUIPMENT PG 03
2 ITEM
3 FMS VNAV _____
4 RADAR ALT _____
5 AFCS TYPE _____
6 AFCS COMMAND BAR _____
7 AFCS MODE ANN _____
8 F/S AIR DATA _____
9 RADAR TYPE _____
10 RADAR CTL PNL _____
11 RADAR INDICATOR _____
12 CHECKLIST _____
13 ..MORE..

1 VIEW/EDIT EQUIPMENT PG 04
2 ITEM
3 JOYSTICK _____
4 TCAS _____
5 HOMING #1 _____
6 HOMING #2 _____
7 LIGHTNING DET _____
8 HOVER MODE _____
9 CABLE MODE _____

1 VIEW/EDIT OPERATING CHAR PG 06
2 ITEM
3 VERT SCALE SIDE _____
4 DCLTR GS ON BC _____
5 FULL TIME FMS MAP _____
6 DISPLAY WIND VEC _____
7 DISPLAY DRIFT _____
8 DG ONLY MODE _____
9 DME DIST ONLY _____
10 RADAR ONLY MODE _____
11 SPARE _____
12 MFD NAV CONTROL _____
13 ..MORE..

System Configuration

1	VIEW/EDIT OPERATING	PG 07
2	ITEM	
3	DISPLAY HDG TAPE	_____
4	COMMAND BARS	_____
5	ROLL INDICATOR	_____
6	DCLTR UNUS ATT	_____
7	CAT II AVAILABLE	_____
8	PERSPECTIVE LINES	_____
9	DH SELECT	_____
10	CTL PNL SYNC	_____
11	SEL HDG SYNC	_____
12	SEL CRS SYNC	_____
13	..MORE..	

1	VIEW/EDIT OPERATING	PG 08
2	ITEM	
3	NORTH UP MAP	_____
4	VERT PTR TYPE	_____
5	DISPLAY FMS MSG	_____
6	SEL HDG COLOR	_____
7	CMD BAR COLOR	_____
8	REV MODE ANN	_____
9	RISING RUNWAY	_____
10	ADI DEV SRC	_____
11	CMD BAR FILTER	_____
12	MLS VRT ANNUNC	_____
13	..MORE..	

1	VIEW/EDIT OPERATING	PG 09
2	ITEM	
3	DATUM SCALING	_____
4	HDG FAIL ANNUNC	_____
5	VNAV APR SCALE	_____
6	LNAV CRS CTRL	_____
7	SG #1 SIDE	_____
8	AIRCRAFT SYMBOL	_____
9	TACAN ANNUNC	_____
10	TCAS DISPLAYS	_____
11	CAT II SENSORS	_____

SOFTWARE 09 CONFIGURATION PAGES

The EHSI, EADI, MFD and Reversion software will display the following pages. All display information will be identical on the EHSI and MFD, however, the EADI will not display the rack configurations, it will display a comparison of the EHSI and EADI configuration data. The descriptions given in this section refer to side 1 as the pilot's side and side 2 as the co-pilot's side.

1	VIEW/EDIT EQUIPMENT	PG 01
2	ITEM	
3	SG NUMBER	_____
4	SINGLE/DUAL	_____
5	DU TYPE	_____
6	ATTITUDE/HDG #1	_____
7	ATTITUDE/HDG #2	_____
8	RATE OF TURN	_____
9	ADF #1	_____
10	ADF #2	_____
11	VOR/ILS #1	_____
12	VOR/ILS #2	_____
13	..MORE..	

1	VIEW/EDIT EQUIPMENT	PG 02
2	ITEM	
3	DME #1	_____
4	DME #2	_____
5	MLS #1	_____
6	MLS #2	_____
7	FMS #1	_____
8	FMS #2	_____
9	RNAV #1	_____
10	RNAV #2	_____
11	TACAN #1	_____
12	TACAN #2	_____
13	..MORE..	

System Configuration

1	VIEW/EDIT EQUIPMENT	PG 03
2	ITEM	
3	FMS VNAV	_____
4	RADAR ALT	_____
5	AFCS TYPE	_____
6	AFCS COMMAND BAR	_____
7	AFCS MODE ANN	_____
8	F/S AIR DATA	_____
9	RADAR TYPE	_____
10	RADAR CTL PNL	_____
11	RADAR INDICATOR	_____
12	CHECKLIST	_____
13	..MORE..	

1	VIEW/EDIT EQUIPMENT	PG 04
2	ITEM	
3	JOYSTICK	_____
4	TCAS	_____
5	HOMING #1	_____
6	HOMING #2	_____
7	LIGHTNING DET	_____
8	HOVER MODE	_____
9	CABLE MODE	_____

1	VIEW/EDIT OPERATING CHAR	PG 06
2	ITEM	
3	VERT SCALE SIDE	_____
4	DCLTR GS ON BC	_____
5	FULL TIME FMS MAP	_____
6	DISPLAY WIND VEC	_____
7	DISPLAY DRIFT	_____
8	DG ONLY MODE	_____
9	DME DIST ONLY	_____
10	RADAR ONLY MODE	_____
11	SPARE	_____
12	MFD NAV CONTROL	_____
13	..MORE..	

1	VIEW/EDIT OPERATING	PG 07
2	ITEM	
3	DISPLAY HDG TAPE	_____
4	ADI PLANE/CMD BAR	_____
5	ROLL INDICATOR	_____
6	DCLTR UNUS ATT	_____
7	CAT II AVAILABLE	_____
8	PERSPECTIVE LINES	_____
9	DH SELECT	_____
10	CTL PNL SYNC	_____
11	SEL HDG SYNC	_____
12	SEL CRS SYNC	_____
13	..MORE..	

1	VIEW/EDIT OPERATING	PG 08
2	ITEM	
3	NORTH UP MAP	_____
4	VERT PTR TYPE	_____
5	DISPLAY FMS MSG	_____
6	SEL HDG COLOR	_____
7	CMD BAR COLOR	_____
8	REV MODE ANN	_____
9	RISING RUNWAY	_____
10	ADI DEV SRC	_____
11	CMD BAR FILTER	_____
12	MLS VRT ANNUNC	_____
13	..MORE..	

1	VIEW/EDIT OPERATING	PG 09
2	ITEM	
3	DATUM SCALING	_____
4	HDG FAIL ANNUNC	_____
5	VNAV APR SCALE	_____
6	LNAV CRS CTRL	_____
7	SG #1 SIDE	_____
8	AIRCRAFT SYMBOL	_____
9	TACAN ANNUNC	_____
10	TCAS DISPLAYS	_____
11	CAT II SENSORS	_____
12	RADAR SCAN	_____

System Configuration

1	VIEW/EDIT OPERATING	PG 10
2	ITEM	
3	RADAR SDI	

SOFTWARE 10 CONFIGURATION PAGES

The EHSI, EADI, MFD and Reversion software will display the following pages. All display information will be identical on the EHSI and MFD, however, the EADI will not display the rack configurations, it will display a comparison of the EHSI and EADI configuration data. The descriptions given in this section refer to side 1 as the pilot's side and side 2 as the co-pilot's side.

1	VIEW/EDIT EQUIPMENT	PG 01
2	ITEM	
3	SG NUMBER	_____
4	SINGLE/DUAL	_____
5	DU TYPE	_____
6	ATTITUDE/HDG #1	_____
7	ATTITUDE/HDG #2	_____
8	RATE OF TURN	_____
9	ADF #1	_____
10	ADF #2	_____
11	VOR/ILS #1	_____
12	VOR/ILS #2	_____
13	..MORE..	

1	VIEW/EDIT EQUIPMENT	PG 02
2	ITEM	
3	DME #1	_____
4	DME #2	_____
5	MLS #1	_____
6	MLS #2	_____
7	FMS #1	_____
8	FMS #2	_____
9	RNAV #1	_____
10	RNAV #2	_____
11	TACAN #1	_____
12	TACAN #2	_____
13	..MORE..	

System Configuration

1	VIEW/EDIT EQUIPMENT	PG 03
2	ITEM	
3	FMS VNAV	_____
4	RADAR ALT	_____
5	AFCS TYPE	_____
6	AFCS COMMAND BAR	_____
7	AFCS MODE ANN	_____
8	F/S AIR DATA	_____
9	RADAR TYPE	_____
10	RADAR CTL PNL	_____
11	RADAR INDICATOR	_____
12	CHECKLIST	_____
13	..MORE..	

1	VIEW/EDIT EQUIPMENT	PG 04
2	ITEM	
3	JOYSTICK	_____
4	TCAS	_____
5	HOMING #1	_____
6	HOMING #2	_____
7	LIGHTNING DET	_____
8	HOVER MODE	_____
9	CABLE MODE	_____

1	VIEW/EDIT OPERATING CHAR	PG 06
2	ITEM	
3	VERT SCALE SIDE	_____
4	DCLTR GS ON BC	_____
5	FULL TIME FMS MAP	_____
6	DISPLAY WIND VEC	_____
7	DISPLAY DRIFT	_____
8	DG ONLY MODE	_____
9	DME DIST ONLY	_____
10	RADAR ONLY MODE	_____
11	SPARE	_____
12	MFD NAV CONTROL	_____
13	..MORE..	

1 VIEW/EDIT OPERATING PG 07
2 ITEM
3 DISPLAY HDG TAPE _____
4 ADI PLANE/CMD BAR _____
5 ROLL INDICATOR _____
6 DCLTR UNUS ATT _____
7 CAT II AVAILABLE _____
8 PERSPECTIVE LINES _____
9 DH SELECT _____
10 CTL PNL SYNC _____
11 SEL HDG SYNC _____
12 SEL CRS SYNC _____
13 ..MORE..

1 VIEW/EDIT OPERATING PG 08
2 ITEM
3 NORTH UP MAP _____
4 VERT PTR TYPE _____
5 DISPLAY FMS MSG _____
6 SEL HDG COLOR _____
7 CMD BAR COLOR _____
8 REV MODE ANN _____
9 RISING RUNWAY _____
10 ADI DEV SRC _____
11 CMD BAR FILTER _____
12 MLS VRT ANNUNC _____
13 ..MORE..

1 VIEW/EDIT OPERATING PG 09
2 ITEM
3 DATUM SCALING _____
4 HDG FAIL ANNUNC _____
5 VNAV APR SCALE _____
6 LNAV CRS CTRL _____
7 SG #1 SIDE _____
8 AIRCRAFT SYMBOL _____
9 TACAN ANNUNC _____
10 TCAS DISPLAYS _____
11 CAT II SENSORS _____
12 RADAR SCAN _____

System Configuration

1	VIEW/EDIT OPERATING	PG 10
2	ITEM	
3	RADAR SDI	
4	PITCH SYNC DISC	

SOFTWARE 11 CONFIGURATION PAGES

The EHSI, EADI, MFD and Reversion software will display the following pages. All display information will be identical on the EHSI and MFD, however, the EADI will not display the rack configurations, it will display a comparison of the EHSI and EADI configuration data. The descriptions given in this section refer to side 1 as the pilot's side and side 2 as the co-pilot's side.

1	VIEW/EDIT EQUIPMENT	PG 01
2	ITEM	
3	SG NUMBER	_____
4	SINGLE/DUAL	_____
5	DU TYPE	_____
6	ATTITUDE/HDG #1	_____
7	ATTITUDE/HDG #2	_____
8	RATE OF TURN	_____
9	ADF #1	_____
10	ADF #2	_____
11	VOR/ILS #1	_____
12	VOR/ILS #2	_____
13	..MORE..	

1	VIEW/EDIT EQUIPMENT	PG 02
2	ITEM	
3	DME #1	_____
4	DME #2	_____
5	MLS #1	_____
6	MLS #2	_____
7	FMS #1	_____
8	FMS #2	_____
9	RNAV #1	_____
10	RNAV #2	_____
11	TACAN #1	_____
12	TACAN #2	_____
13	..MORE..	

System Configuration

_____ |
1 VIEW/EDIT EQUIPMENT PG 03
2 ITEM
3 FMS VNAV _____
4 RADAR ALT _____
5 AFCS TYPE _____
6 AFCS COMMAND BAR _____
7 AFCS MODE ANN _____
8 F/S AIR DATA _____
9 RADAR TYPE _____
10 RADAR CTL PNL _____
11 RADAR INDICATOR _____
12 CHECKLIST _____
13 ..MORE..

_____ |
1 VIEW/EDIT EQUIPMENT PG 04
2 ITEM
3 JOYSTICK _____
4 TCAS _____
5 HOMING #1 _____
6 HOMING #2 _____
7 LIGHTNING DET _____
8 HOVER MODE _____
9 CABLE MODE _____
10 VARIABLE LNAV _____

_____ |
1 VIEW/EDIT OPERATING CHAR PG 06
2 ITEM
3 VERT SCALE SIDE _____
4 DCLTR GS ON BC _____
5 FULL TIME FMS MAP _____
6 DISPLAY WIND VEC _____
7 DISPLAY DRIFT _____
8 DG ONLY MODE _____
9 DME DIST ONLY _____
10 RADAR ONLY MODE _____
11 SPARE _____
12 MFD NAV CONTROL _____
13 ..MORE..

1	VIEW/EDIT OPERATING	PG 07
2	ITEM	
3	DISPLAY HDG TAPE	_____
4	ADI PLANE/CMD BAR	_____
5	ROLL INDICATOR	_____
6	DCLTR UNUS ATT	_____
7	CAT II AVAILABLE	_____
8	PERSPECTIVE LINES	_____
9	DH SELECT	_____
10	CTL PNL SYNC	_____
11	SEL HDG SYNC	_____
12	SEL CRS SYNC	_____
13	..MORE..	

1	VIEW/EDIT OPERATING	PG 08
2	ITEM	
3	NORTH UP MAP	_____
4	VERT PTR TYPE	_____
5	DISPLAY FMS MSG	_____
6	SEL HDG COLOR	_____
7	CMD BAR COLOR	_____
8	REV MODE ANN	_____
9	RISING RUNWAY	_____
10	ADI DEV SRC	_____
11	CMD BAR FILTER	_____
12	MLS VRT ANNUNC	_____
13	..MORE..	

1	VIEW/EDIT OPERATING	PG 09
2	ITEM	
3	DATUM SCALING	_____
4	HDG FAIL ANNUNC	_____
5	VNAV APR SCALE	_____
6	LNAV CRS CTRL	_____
7	SG #1 SIDE	_____
8	AIRCRAFT SYMBOL	_____
9	TACAN ANNUNC	_____
10	TCAS DISPLAYS	_____
11	CAT II SENSORS	_____
12	RADAR SCAN	_____

System Configuration

1	VIEW/EDIT OPERATING	PG 10
2	ITEM	
3	RADAR SDI	

SOFTWARE 12 CONFIGURATION PAGES

The EHSI, EADI, MFD and Reversion software will display the following pages. All display information will be identical on the EHSI and MFD, however, the EADI will not display the rack configurations, it will display a comparison of the EHSI and EADI configuration data. The descriptions given in this section refer to side 1 as the pilot's side and side 2 as the co-pilot's side.

1	VIEW/EDIT EQUIPMENT	PG 01
2	ITEM	
3	SG NUMBER	_____
4	SINGLE/DUAL	_____
5	DU TYPE	_____
6	ATTITUDE/HDG #1	_____
7	ATTITUDE/HDG #2	_____
8	RATE OF TURN	_____
9	ADF #1	_____
10	ADF #2	_____
11	VOR/ILS #1	_____
12	VOR/ILS #2	_____
13	..MORE..	

1	VIEW/EDIT EQUIPMENT	PG 02
2	ITEM	
3	DME #1	_____
4	DME #2	_____
5	MLS #1	_____
6	MLS #2	_____
7	FMS #1	_____
8	FMS #2	_____
9	RNAV #1	_____
10	RNAV #2	_____
11	TACAN #1	_____
12	TACAN #2	_____
13	..MORE..	

System Configuration

1	VIEW/EDIT EQUIPMENT	PG 03
2	ITEM	
3	FMS VNAV	_____
4	RADAR ALT	_____
5	AFCS TYPE	_____
6	AFCS COMMAND BAR	_____
7	AFCS MODE ANN	_____
8	F/S AIR DATA	_____
9	RADAR TYPE	_____
10	RADAR CTL PNL	_____
11	RADAR INDICATOR	_____
12	CHECKLIST	_____
13	..MORE..	

1	VIEW/EDIT EQUIPMENT	PG 04
2	ITEM	
3	JOYSTICK	_____
4	TCAS	_____
5	HOMING #1	_____
6	HOMING #2	_____
7	LIGHTNING DET	_____
8	HOVER MODE	_____
9	CABLE MODE	_____
10	VARIABLE LNAV	_____

1	VIEW/EDIT OPERATING CHAR	PG 06
2	ITEM	
3	VERT SCALE SIDE	_____
4	DCLTR GS ON BC	_____
5	FULL TIME FMS MAP	_____
6	DISPLAY WIND VEC	_____
7	DISPLAY DRIFT	_____
8	DG ONLY MODE	_____
9	DME DIST ONLY	_____
10	RADAR ONLY MODE	_____
11	SPARE	_____
12	MFD NAV CONTROL	_____
13	..MORE..	

1	VIEW/EDIT OPERATING	PG 07
2	ITEM	
3	DISPLAY HDG TAPE	_____
4	ADI PLANE/CMD BAR	_____
5	ROLL INDICATOR	_____
6	DCLTR UNUS ATT	_____
7	CAT II AVAILABLE	_____
8	PERSPECTIVE LINES	_____
9	DH SELECT	_____
10	CTL PNL SYNC	_____
11	SEL HDG SYNC	_____
12	SEL CRS SYNC	_____
13	..MORE..	

1	VIEW/EDIT OPERATING	PG 08
2	ITEM	
3	NORTH UP MAP	_____
4	VERT PTR TYPE	_____
5	DISPLAY FMS MSG	_____
6	SEL HDG COLOR	_____
7	CMD BAR COLOR	_____
8	REV MODE ANN	_____
9	RISING RUNWAY	_____
10	ADI DEV SRC	_____
11	CMD BAR FILTER	_____
12	MLS VRT ANNUNC	_____
13	..MORE..	

1	VIEW/EDIT OPERATING	PG 09
2	ITEM	
3	DATUM SCALING	_____
4	HDG FAIL ANNUNC	_____
5	VNAV APR SCALE	_____
6	LNAV CRS CTRL	_____
7	SG #1 SIDE	_____
8	AIRCRAFT SYMBOL	_____
9	TACAN ANNUNC	_____
10	TCAS DISPLAYS	_____
11	CAT II SENSORS	_____
12	RADAR SCAN	_____

System Configuration

1	VIEW/EDIT OPERATING	PG 10
2	ITEM	
3	RADAR SDI	

SOFTWARE 13 CONFIGURATION PAGES

The EHSI, EADI, MFD and Reversion software will display the following pages. All display information will be identical on the EHSI and MFD, however, the EADI will not display the rack configurations, it will display a comparison of the EHSI and EADI configuration data. The descriptions given in this section refer to side 1 as the pilot's side and side 2 as the co-pilot's side.

1	VIEW/EDIT EQUIPMENT	PG 01
2	ITEM	
3	SG NUMBER	_____
4	SINGLE/DUAL	_____
5	DU TYPE	_____
6	ATTITUDE/HDG #1	_____
7	ATTITUDE/HDG #2	_____
8	RATE OF TURN	_____
9	ADF #1	_____
10	ADF #2	_____
11	VOR/ILS #1	_____
12	VOR/ILS #2	_____
13	..MORE..	

1	VIEW/EDIT EQUIPMENT	PG 02
2	ITEM	
3	DME #1	_____
4	DME #2	_____
5	MLS #1	_____
6	MLS #2	_____
7	FMS #1	_____
8	FMS #2	_____
9	RNAV #1	_____
10	RNAV #2	_____
11	TACAN #1	_____
12	TACAN #2	_____
13	..MORE..	

System Configuration

1	VIEW/EDIT EQUIPMENT	PG 03
2	ITEM	
3	FMS VNAV	_____
4	RADAR ALT	_____
5	AFCS TYPE	_____
6	AFCS COMMAND BAR	_____
7	AFCS MODE ANN	_____
8	F/S AIR DATA	_____
9	RADAR TYPE	_____
10	RADAR CTL PNL	_____
11	RADAR INDICATOR	_____
12	CHECKLIST	_____
13	..MORE..	

1	VIEW/EDIT EQUIPMENT	PG 04
2	ITEM	
3	JOYSTICK	_____
4	TCAS	_____
5	HOMING #1	_____
6	HOMING #2	_____
7	LIGHTNING DET	_____
8	HOVER MODE	_____
9	CABLE MODE	_____
10	VARIABLE LNAV	_____

1	VIEW/EDIT OPERATING CHAR	PG 06
2	ITEM	
3	VERT SCALE SIDE	_____
4	DCLTR GS ON BC	_____
5	FULL TIME FMS MAP	_____
6	DISPLAY WIND VEC	_____
7	DISPLAY DRIFT	_____
8	DG ONLY MODE	_____
9	DME DIST ONLY	_____
10	RADAR ONLY MODE	_____
11	SPARE	_____
12	MFD NAV CONTROL	_____
13	..MORE..	

1	VIEW/EDIT OPERATING	PG 07
2	ITEM	
3	DISPLAY HDG TAPE	_____
4	ADI PLANE/CMD BAR	_____
5	ROLL INDICATOR	_____
6	DCLTR UNUS ATT	_____
7	CAT II AVAILABLE	_____
8	PERSPECTIVE LINES	_____
9	DH SELECT	_____
10	CTL PNL SYNC	_____
11	SEL HDG SYNC	_____
12	SEL CRS SYNC	_____
13	..MORE..	

1	VIEW/EDIT OPERATING	PG 08
2	ITEM	
3	NORTH UP MAP	_____
4	VERT PTR TYPE	_____
5	DISPLAY FMS MSG	_____
6	SEL HDG COLOR	_____
7	CMD BAR COLOR	_____
8	REV MODE ANN	_____
9	RISING RUNWAY	_____
10	ADI DEV SRC	_____
11	CMD BAR FILTER	_____
12	MLS VRT ANNUNC	_____
13	..MORE..	

1	VIEW/EDIT OPERATING	PG 09
2	ITEM	
3	DATUM SCALING	_____
4	HDG FAIL ANNUNC	_____
5	VNAV APR SCALE	_____
6	LNAV CRS CTRL	_____
7	SG #1 SIDE	_____
8	AIRCRAFT SYMBOL	_____
9	TACAN ANNUNC	_____
10	TCAS DISPLAYS	_____
11	CAT II SENSORS	_____
12	RADAR SCAN	_____

System Configuration

1	VIEW/EDIT OPERATING	PG 10
2	ITEM	
3	RADAR SDI	_____
4	PITCH SYNC DISC	_____
5	ADF PTR HOLD DST	_____

SOFTWARE 14 CONFIGURATION PAGES

The EHSI, EADI, MFD and Reversion software will display the following pages. All display information will be identical on the EHSI and MFD, however, the EADI will not display the rack configurations, it will display a comparison of the EHSI and EADI configuration data. The descriptions given in this section refer to side 1 as the pilot's side and side 2 as the co-pilot's side.

1	VIEW/EDIT EQUIPMENT	PG 01
2	ITEM	
3	SG NUMBER	_____
4	SINGLE/DUAL	_____
5	DU TYPE	_____
6	ATTITUDE/HDG #1	_____
7	ATTITUDE/HDG #2	_____
8	RATE OF TURN	_____
9	ADF #1	_____
10	ADF #2	_____
11	VOR/ILS #1	_____
12	VOR/ILS #2	_____
13	..MORE..	

1	VIEW/EDIT EQUIPMENT	PG 02
2	ITEM	
3	DME #1	_____
4	DME #2	_____
5	MLS #1	_____
6	MLS #2	_____
7	FMS #1	_____
8	FMS #2	_____
9	RNAV #1	_____
10	RNAV #2	_____
11	TACAN #1	_____
12	TACAN #2	_____
13	..MORE..	

System Configuration

_____ |
1 VIEW/EDIT EQUIPMENT PG 03
2 ITEM
3 FMS VNAV _____
4 RADAR ALT _____
5 AFCS TYPE _____
6 AFCS COMMAND BAR _____
7 AFCS MODE ANN _____
8 F/S AIR DATA _____
9 RADAR TYPE _____
10 RADAR CTL PNL _____
11 RADAR INDICATOR _____
12 CHECKLIST _____
13 ..MORE..

_____ |
1 VIEW/EDIT EQUIPMENT PG 04
2 ITEM
3 JOYSTICK _____
4 TCAS _____
5 HOMING #1 _____
6 HOMING #2 _____
7 LIGHTNING DET _____
8 HOVER MODE _____
9 CABLE MODE _____
10 VARIABLE LNAV _____
11 EGPWS _____

_____ |
1 VIEW/EDIT OPERATING CHAR PG 06
2 ITEM
3 VERT SCALE SIDE _____
4 DCLTR GS ON BC _____
5 FULL TIME FMS MAP _____
6 DISPLAY WIND VEC _____
7 DISPLAY DRIFT _____
8 DG ONLY MODE _____
9 DME DIST ONLY _____
10 RADAR ONLY MODE _____
11 SPARE _____
12 MFD NAV CONTROL _____
13 ..MORE..

1 VIEW/EDIT OPERATING PG 07
2 ITEM
3 DISPLAY HDG TAPE _____
4 ADI PLANE/CMD BAR _____
5 ROLL INDICATOR _____
6 DCLTR UNUS ATT _____
7 CAT II AVAILABLE _____
8 PERSPECTIVE LINES _____
9 DH SELECT _____
10 CTL PNL SYNC _____
11 SEL HDG SYNC _____
12 SEL CRS SYNC _____
13 ..MORE..

1 VIEW/EDIT OPERATING PG 08
2 ITEM
3 NORTH UP MAP _____
4 VERT PTR TYPE _____
5 DISPLAY FMS MSG _____
6 SEL HDG COLOR _____
7 CMD BAR COLOR _____
8 REV MODE ANN _____
9 RISING RUNWAY _____
10 ADI DEV SRC _____
11 CMD BAR FILTER _____
12 MLS VRT ANNUNC _____
13 ..MORE..

1 VIEW/EDIT OPERATING PG 09
2 ITEM
3 DATUM SCALING _____
4 HDG FAIL ANNUNC _____
5 VNAV APR SCALE _____
6 LNAV CRS CTRL _____
7 SG #1 SIDE _____
8 AIRCRAFT SYMBOL _____
9 TACAN ANNUNC _____
10 TCAS DISPLAYS _____
11 CAT II SENSORS _____
12 RADAR SCAN _____

System Configuration

1	VIEW/EDIT OPERATING	PG 10
2	ITEM	
3	RADAR SDI	
4	PITCH SYNC DISC	
5	ADF PTR HOLD DST	
6	FMS OUTPUT BUS	

SOFTWARE 15 CONFIGURATION PAGES

The EHSI, EADI, MFD and Reversion software will display the following pages. All display information will be identical on the EHSI and MFD, however, the EADI will not display the rack configurations, it will display a comparison of the EHSI and EADI configuration data. The descriptions given in this section refer to side 1 as the pilot's side and side 2 as the co-pilot's side.

1	VIEW/EDIT EQUIPMENT	PG 01
2	ITEM	
3	SG NUMBER	_____
4	SINGLE/DUAL	_____
5	DU TYPE	_____
6	ATTITUDE/HDG #1	_____
7	ATTITUDE/HDG #2	_____
8	RATE OF TURN	_____
9	ADF #1	_____
10	ADF #2	_____
11	VOR/ILS #1	_____
12	VOR/ILS #2	_____
13	..MORE..	

1	VIEW/EDIT EQUIPMENT	PG 02
2	ITEM	
3	DME #1	_____
4	DME #2	_____
5	MLS #1	_____
6	MLS #2	_____
7	FMS #1	_____
8	FMS #2	_____
9	RNAV #1	_____
10	RNAV #2	_____
11	TACAN #1	_____
12	TACAN #2	_____
13	..MORE..	

System Configuration

_____ |
1 VIEW/EDIT EQUIPMENT PG 03
2 ITEM
3 FMS VNAV _____
4 RADAR ALT _____
5 AFCS TYPE _____
6 AFCS COMMAND BAR _____
7 AFCS MODE ANN _____
8 F/S AIR DATA _____
9 RADAR TYPE _____
10 RADAR CTL PNL _____
11 RADAR INDICATOR _____
12 CHECKLIST _____
13 ..MORE..

_____ |
1 VIEW/EDIT EQUIPMENT PG 04
2 ITEM
3 JOYSTICK _____
4 TCAS _____
5 HOMING #1 _____
6 HOMING #2 _____
7 LIGHTNING DET _____
8 HOVER MODE _____
9 CABLE MODE _____
10 VARIABLE LNAV _____
11 EGPWS _____
12 VARIABLE VNAV _____

_____ |
1 VIEW/EDIT OPERATING CHAR PG 06
2 ITEM
3 VERT SCALE SIDE _____
4 DCLTR GS ON BC _____
5 FULL TIME FMS MAP _____
6 DISPLAY WIND VEC _____
7 DISPLAY DRIFT _____
8 DG ONLY MODE _____
9 DME DIST ONLY _____
10 RADAR ONLY MODE _____
11 SPARE _____
12 MFD NAV CONTROL _____
13 ..MORE..

1	VIEW/EDIT OPERATING	PG 07
2	ITEM	
3	DISPLAY HDG TAPE	_____
4	ADI PLANE/CMD BAR	_____
5	ROLL INDICATOR	_____
6	DCLTR UNUS ATT	_____
7	CAT II AVAILABLE	_____
8	PERSPECTIVE LINES	_____
9	DH SELECT	_____
10	CTL PNL SYNC	_____
11	SEL HDG SYNC	_____
12	SEL CRS SYNC	_____
13	..MORE..	

1	VIEW/EDIT OPERATING	PG 08
2	ITEM	
3	NORTH UP MAP	_____
4	VERT PTR TYPE	_____
5	DISPLAY FMS MSG	_____
6	SEL HDG COLOR	_____
7	CMD BAR COLOR	_____
8	REV MODE ANN	_____
9	RISING RUNWAY	_____
10	ADI DEV SRC	_____
11	CMD BAR FILTER	_____
12	MLS VRT ANNUNC	_____
13	..MORE..	

1	VIEW/EDIT OPERATING	PG 09
2	ITEM	
3	DATUM SCALING	_____
4	HDG FAIL ANNUNC	_____
5	VNAV APR SCALE	_____
6	LNAV CRS CTRL	_____
7	SG #1 SIDE	_____
8	AIRCRAFT SYMBOL	_____
9	TACAN ANNUNC	_____
10	TCAS DISPLAYS	_____
11	CAT II SENSORS	_____
12	RADAR SCAN	_____

System Configuration

1	VIEW/EDIT OPERATING	PG 10
2	ITEM	
3	RADAR SDI	_____
4	PITCH SYNC DISC	_____
5	ADF PTR HOLD DST	_____
6	FMS OUTPUT BUS	_____
7	LNAV VERT APR	_____
8	L/VNAV VERT APR	_____
9	LP VERT APR	_____
10	LPV VERT APR	_____
11	LNAV SELECT OUT	_____

SOFTWARE 16 CONFIGURATION PAGES

The EHSI, EADI, MFD and Reversion software will display the following pages. All display information will be identical on the EHSI and MFD, however, the EADI will not display the rack configurations, it will display a comparison of the EHSI and EADI configuration data. The descriptions given in this section refer to side 1 as the pilot's side and side 2 as the co-pilot's side.

1	VIEW/EDIT EQUIPMENT		PG 01
2	ITEM		
3	SG NUMBER	_____	
4	SINGLE/DUAL	_____	
5	DU TYPE	_____	
6	ATTITUDE/HDG #1	_____	
7	ATTITUDE/HDG #2	_____	
8	RATE OF TURN	_____	
9	ADF #1	_____	
10	ADF #2	_____	
11	VOR/ILS #1	_____	
12	VOR/ILS #2	_____	
13	..MORE..		

1	VIEW/EDIT EQUIPMENT		PG 02
2	ITEM		
3	DME #1	_____	
4	DME #2	_____	
5	MLS #1	_____	
6	MLS #2	_____	
7	FMS #1	_____	
8	FMS #2	_____	
9	RNAV #1	_____	
10	RNAV #2	_____	
11	TACAN #1	_____	
12	TACAN #2	_____	

System Configuration

_____ |
1 VIEW/EDIT EQUIPMENT PG 03
2 ITEM
3 FMS VNAV _____
4 RADAR ALT _____
5 AFCS TYPE _____
6 AFCS COMMAND BAR _____
7 AFCS MODE ANN _____
8 F/S AIR DATA _____
9 RADAR TYPE _____
10 RADAR CTL PNL _____
11 RADAR INDICATOR _____
12 CHECKLIST _____
13 ..MORE..

_____ |
1 VIEW/EDIT EQUIPMENT PG 04
2 ITEM
3 JOYSTICK _____
4 TCAS _____
5 HOMING #1 _____
6 HOMING #2 _____
7 LIGHTNING DET _____
8 HOVER MODE _____
9 CABLE MODE _____
10 VARIABLE LNAV _____
11 EGPWS _____
12 VARIABLE VNAV _____

_____ |
1 VIEW/EDIT OPERATING CHAR PG 06
2 ITEM
3 VERT SCALE SIDE _____
4 DCLTR GS ON BC _____
5 FULL TIME FMS MAP _____
6 DISPLAY WIND VEC _____
7 DISPLAY DRIFT _____
8 DG ONLY MODE _____
9 DME DIST ONLY _____
10 RADAR ONLY MODE _____
11 SPARE _____
12 MFD NAV CONTROL _____
13 ..MORE..

1 VIEW/EDIT OPERATING PG 07
2 ITEM
3 DISPLAY HDG TAPE _____
4 ADI PLANE/CMD BAR _____
5 ROLL INDICATOR _____
6 DCLTR UNUS ATT _____
7 CAT II AVAILABLE _____
8 PERSPECTIVE LINES _____
9 DH SELECT _____
10 CTL PNL SYNC _____
11 SEL HDG SYNC _____
12 SEL CRS SYNC _____
13 ..MORE..

1 VIEW/EDIT OPERATING PG 08
2 ITEM
3 NORTH UP MAP _____
4 VERT PTR TYPE _____
5 DISPLAY FMS MSG _____
6 SEL HDG COLOR _____
7 CMD BAR COLOR _____
8 REV MODE ANN _____
9 RISING RUNWAY _____
10 ADI DEV SRC _____
11 CMD BAR FILTER _____
12 MLS VRT ANNUNC _____
13 ..MORE..

1 VIEW/EDIT OPERATING PG 09
2 ITEM
3 DATUM SCALING _____
4 HDG FAIL ANNUNC _____
5 VNAV APR SCALE _____
6 LNAV CRS CTRL _____
7 SG #1 SIDE _____
8 AIRCRAFT SYMBOL _____
9 TACAN ANNUNC _____
10 TCAS DISPLAYS _____
11 CAT II SENSORS _____
12 RADAR SCAN _____

System Configuration

1	VIEW/EDIT OPERATING	PG 10
2	ITEM	
3	RADAR SDI	_____
4	PITCH SYNC DISC	_____
5	ADF PTR HOLD DST	_____
6	FMS OUTPUT BUS	_____
7	LNAV VERT APR	_____
8	L/VNAV VERT APR	_____
9	LP VERT APR	_____
10	LPV VERT APR	_____
11	LNAV SELECT OUT	_____

EHSI OPERATION

DETAILED OPERATING CONTROLS

All possible EFS 40/50 Interfacing Equipment is described in the Detailed Operating Controls section of the EFS 40/50 Pilot's Guide, however, all may not be active in a specific installation.

This section, EHSI Operation, will describe the operation of both

the ED 461 control display unit, CP 468 EHSI control panel and the EHSI section of the CP 467 EHSI/EADI control panel. The EADI operation of the CP 467 is covered in section 2.2, EADI Operation. The CP 466A/B radar control panels are covered in section 2.3, RADAR Operation.



Figure 2.1
ED 461 EHSI



*Figure 2.2
ED 462 Display Unit & Companion
CP 468 Control Panel*

For clarification on a particular display or operational feature, refer to section IV. EHSI DISPLAYS or section V. OPERATING INSTRUCTIONS. Figure 2.1 shows the ED 461 combined

control/display unit and figure 2.2 shows the CP 468 dedicated stand-alone EHSI mode controller and companion ED 462 display unit.

EHSI CONTROLS (ED 461 & CP 467/468)

1-2 NAVIGATION SYSTEM SELECT

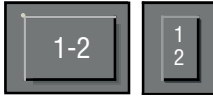

The 1-2 button is used to cycle between primary navigation sensor system #1 and #2 for display. The primary NAV system selected is annunciated as sensor 1 or sensor 2 on the EHSI. Example, if VOR 1 is being displayed and the 1-2 button is pressed, VOR 2 will become the displayed sensor. If only one sensor is installed, the display will not cycle and the sensor annunciation will not show a system number. For example ADF would be displayed (not ADF 1) in installations containing a single ADF.

Note: *The cross-side sensor for VOR could be TCN, for LNAVs it could be a combination of FMS, GPS, OMG or LOR. Beginning with software 08, the 1-2 button no longer selects between unlike LNAV sources.*

Software release 0402 added "FUNCTION NOT IMPLEMENTED" annunciation when either the 1-2, RMI or NAV sensor select button is pressed and it is not active in the system. A yellow FUNCTION NOT IMPLEMENTED will be displayed in the center of the screen.

NAV NAVIGATION SENSOR SELECT



During installation, the EFS 40/50 symbol generator was programmed with the type and quantity of each piece of interfacing equipment. Not all the equipment interfaced to the EFS 40/50 is usable for primary navigation. The EFS 40/50 creates and maintains in permanent memory a list of the interfacing navigation sensors.

The NAV push button is used to select which NAV sensor provides primary navigation data. A press of the NAV sensor select button sequentially selects the next available sensor from the list of those installed. Primary Navigation Data is defined as the distance in the upper right corner, selected course, course pointer and deviation.

EHSI Operation

The Primary Navigation Sensor is annunciated at the side of the display unit opposite the vertical scale. Only those sensors interfaced to the EFS 40/50 in a specific installation will be selectable for use and display.

For installations with dual VOR/ILS receivers and a KNS 81, the KNS 81 will be programmed as an RNAV. The annunciation displayed on the EHSI for this configuration will be NAV and will not change as modes on the KNS 81 are changed. The sensor annunciation and associated navigation data colors will change to match the normal enroute or approach

color scheme, green for on-side approach navigation data, cyan for on-side non approach navigation data and yellow for off-side navigation data.

Software 04 added two new helicopter navigation sensor options, Doppler (DOPP) and Cable (CAB). These sensors require unique display formats, therefore when they are selected for display their unique format will be presented and are not changeable by the HSI or ARC button.

The following is an all-inclusive list, in order, of primary navigation sensors that may be interfaced with the EFS 40/50:

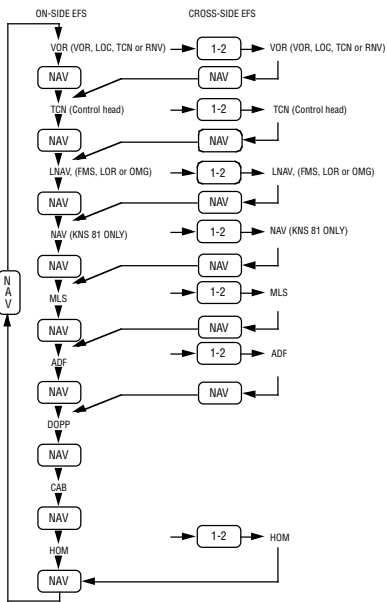

SOFTWARE 04/05/06/07

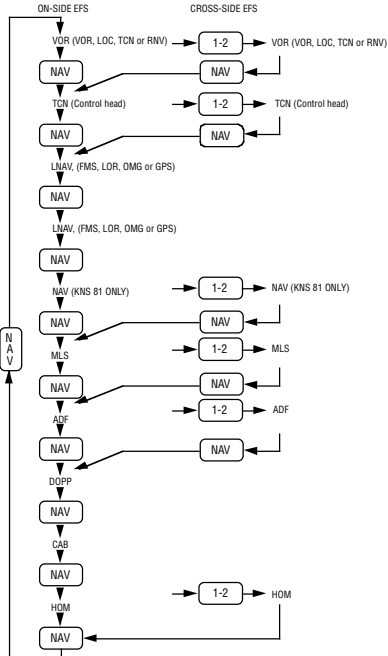

SOFTWARE 08 OR LATER

See Section 4 for display details on Doppler, Cable and Homing.

The display selection list may include the following:

Note: If a number 2 NAV sensor has been selected for display on the number 1 EHSI by pressing the 1-2 button and the number 1 EHSI NAV push button is pressed, the next available number 1 NAV sensor will be selected.

ADF D-Bar presentation may not be available if the ADF does not provide a suitable flag output.

Software 08 treats unlike LNAV sources (i.e. FMS, LOR, OMG, or GPS) as single sensors. When two unlike LNAV sources are configured, the EFS will display both the on-side LNAV and the off-side LNAV without a system number and the NAV button is used to select between them.

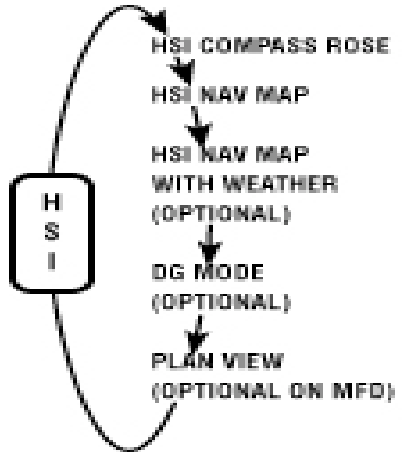

DG and WEATHER are options selected at the time of installation and are included in the system certification. Software 06 added lightning detection presentation.

If a compatible weather radar or lightning detection is not installed, the weather option will not be in the sequence.

HSI 360° MODE SELECTION



The EFS 40/50 EHSI has four possible 360-degree display formats: standard HSI compass rose, NAV map, NAV map with weather, and DG mode. Each press of the HSI button sequentially selects the next display format. A press of the HSI button while in the ARC mode will change the display to the standard HSI compass rose.

Software release 05 added a Heading Bug to the DG mode. Primary use of this display format is for training or as an option to provide an uncluttered display for an NDB approach (using the EHSI as an ADF RMI).

Software release 07 provides the additional, optional display format of "Plan View" which can be configured for display on the MFD only.

BEARING POINTER SELECT



The bearing pointer select buttons work in a similar manner as the NAV sensor select button. A press of the bearing pointer button sequentially selects the next available sensor for display. The bearing pointer sensor list contains only those sensors which have bearing information capabilities. If the selected sensor has distance information paired with it, that distance will also be displayed below the sensor annun-

ciation. An optional push button sequence allows independent selection and display of the respective DME distance without the presence of the bearing pointer.

Example: For a single ADF installation, the ADF bearing pointer may be displayed on either the single or double bar pointer. The annunciation associated with either bearing pointer will be ADF, not ADF 1 or ADF 2.

The following is an all-inclusive list, in order, of the bearing pointer sensors that may be interfaced with the EFS 40/50:

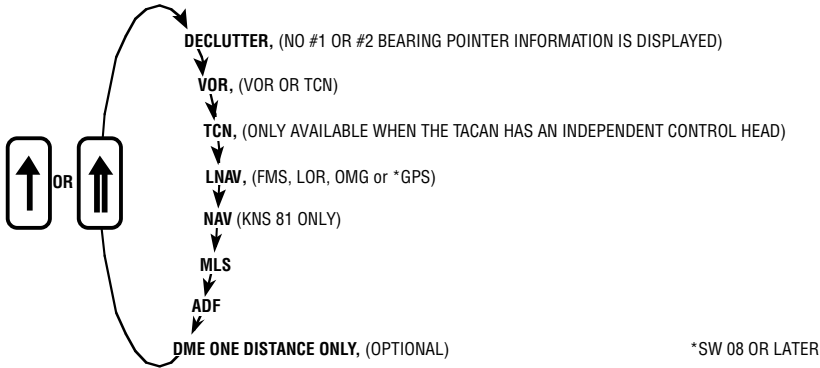

*SW 08 OR LATER

Only those sensors interfaced to the EFS 40/50 will be included in the sequence.

Note: Software release 05 allows single bearing sensors to be displayed on either bearing pointer. Software release 07 and higher, the DME only field can be configured to annunciate 'DME' or 'NAV'.

**ARC SECTORED
MODE SELECTION**



The ARC mode provides the pilot a large scale view of the CDI by presenting an approximate 85-degree sector display of the compass.

The EFS 40/50 EHSI has five possible ARC sectored display formats: standard HSI compass rose, NAV CDI map, NAV CDI map with weather and standard HSI compass rose with weather. Software release 05 provides a configuration option, selectable at

the time of installation and certification, that allows a weather only mode to be selected on the MFD. A press of the ARC button will sequentially select the possible display formats.

A press of the ARC button while in the 360-degree mode will result in an ARC presentation of the same format. For example, if the 360 NAV MAP WITH WEATHER mode is being displayed and the ARC button is pressed, the resulting display format will be ARC NAV MAP WITH WEATHER.

The ARC display selection list may include the following:

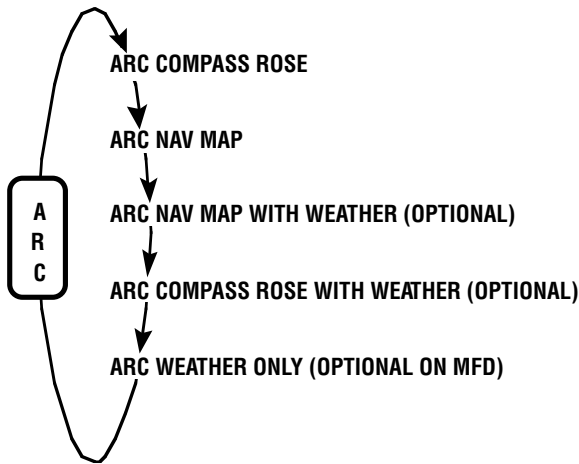

WEATHER is an option selected at the time of installation and is included in the system certification. If a compatible weather radar is not installed, the weather option will not be in the sequence.

Software release 05 provides MFD, multi function display, capabilities. If an MFD is installed, an additional ARC format option is offered, selectable at the time of installation and certification, which provides an

EHSI Operation

uncluttered weather radar presentation. The MFD ARC weather only format provides a typical weather radar presentation, no navigation data is presented when this mode is selected.

Refer to radar controls in this section for details on weather radar operation.

RANGE SELECTION



A press of the RANGE DOWN button selects the next lower range to be displayed while in the NAV MAP or WEATHER modes of operation. Once the lowest selectable range is reached, the RANGE UP button must be used for a range change.

The operation of the RANGE UP button is similar to the RANGE DOWN except it selects the next higher range to be displayed while in the NAV MAP or WEATHER modes of operation.

TST/REF



The TST/REF button will perform SELF TEST display, Ground speed, Time-to-Station or LNAV formatting selections with software 04/05/06/07.

The TST/REF button will perform SELF TEST or LNAV formatting selections with software release 08 and higher.

w TST—

To display the EHSI system SELF TEST, press and hold the TST/REF button for three seconds. Upon entering Self Test, a test pattern will be displayed. In the center of the test pattern, either a SELF TEST PASS or SELF TEST FAIL will be annunciated. With 04/05/06 software, the SELF TEST display will remain until the TST/REF button is pressed again. Beginning with 07 software, the EFS will cancel the test mode and return both the EADI and EHSI to normal operation after 5 seconds.

Note: *If the SELF TEST FAIL message is annunciated, the system should be serviced.*

w REF GROUND SPEED or TIME-TO-STATION selection

With software 04/05/06/07, the TST/REF button allows alternate selection of Ground speed or Time-to-station as calculated by the selected primary NAV system. When Ground speed or Time-to-station information is available it will be displayed below the distance information in the upper right corner of the display. If the information is not provided, the associated annunciator will be removed. The alternate selection of Ground speed and Time-To-Station will not be allowed in the MAP mode with an LNAV selected as the primary navigation source. Beginning with software 08, both

ground speed and time-to-station are displayed simultaneously. Time-To-Station is displayed immediately below the Ground Speed using the format of hours and minutes separated by a colon (H:MM).

Note: *The Time-To-Station field used with software 08 can also be used for an abnormal DME annunciation which has priority.*

The EFS 40/50 will calculate ground speed and time-to-station in installations which use an ARINC 568 type DME. If a conventional DME indicator is also used, differences in ground speed and time-to-station display may be noticed.

Note: *Time-To-Station is replaced with Time-To-Way-point when the selected primary nav is an LNAV providing this information.*

w REF MAP FORMAT

When the selected EFS 40/50 display is LNAV MAP, the TST/REF button allows selection of the desired NAV MAP format. To determine the present MAP format momentarily press the TST/REF button. The momentary button press will activate the present MAP format annunciation. If the displayed format is desired, no additional action is required; the format message will be removed within 5 seconds. If a different format is desired, sequence through the list by momentarily pressing the TST/REF button until the desired format is displayed. Approximately 5 seconds after the last button press, the map format annunciation will be removed.

The following is an all-inclusive list, in order, of the possible NAV MAP formats:

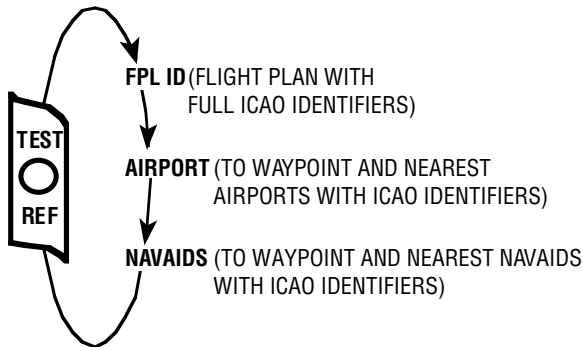

Note: *Depending upon the Flight Management System installed, the above format options may not be fully supported. Systems such as the BENDIX/KING KNS 660, KLN 88, and KLN 90, that support the GAMA 429 LNAV data bus will provide the above format options.*

COURSE SELECT KNOB



Rotation of the COURSE SELECT knob allows the course pointer and digital course to be set at the desired course.

The ED 461, CP 467 and CP 468 provide a "DIRECT TO" feature. Pushing the center of the ED 461 Course Select knob or pulling the CP 467 or CP 468 COURSE SELECT knob will cause the course pointer and digital course readout on the EHSI to slew to the direct course to the selected NAVAID or active waypoint.

If the selected NAV sensor is an LNAV system, it may have modes of operation that control the selected course.

During these LNAV modes of operation the EFS 40/50 COURSE SELECT knob will be inactive.

HEADING SELECT KNOB



Rotation of the HEADING SELECT knob allows the heading bug on the EHSI to be rotated to the desired heading.

The ED 461, CP 467 and CP 468 provide a "HEADING SYNC" feature. Pushing the center of the ED 461 heading select knob or pulling the CP 467 or CP 468 HEADING SELECT knob will cause the heading bug on the EHSI to slew to the present aircraft heading (lubber line).

DISPLAY BRIGHTNESS CONTROL



The BRT knob controls the display brightness.

Note: The display brightness control provides full range dimming to allow night operation in no- or low-light situations. The

lower limit of the display brightness may appear as an inactive tube during normal day-light operation. It is therefore advisable to check the BRT knob setting during preflight test.

To ensure maximum display tube life, it is highly recommended that the display be operated at the lowest acceptable brightness level.

EADI OPERATION

EADI DETAILED OPERATING CONTROLS

This section, EADI Operation, of the EHI 40/50 Pilot's Guide describes the EADI operational controls of the CP 467 and CP 470 used with an ED 462 or ED 551/A EADI.

EADI controls are limited to three basic functions: EADI display brightness adjustment, DH (decision height) set and Radio Altitude test.

For clarification on a particular display or operational feature refer to section IV, EADI DISPLAYS or section V, OPERATING INSTRUCTIONS.

The CP 467 shown in Figure 2.2.1 is used in EFIS installations utilizing an ED 462 or ED 551/A as the EHSI. The CP 470 shown in Figure 2.2.2 is used in EFIS installations utilizing the ED 461 EHSI control display unit with an ED 462 EADI.



Figure 2.2.1
CP 467 EFIS CONTROL PANEL

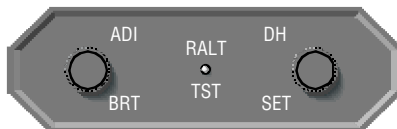
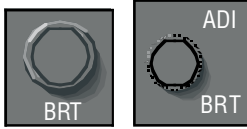

Figure 2.2.2
CP 470 EADI CONTROL PANEL

BRIGHTNESS



The BRT knob controls the display brightness.

Note: *The display brightness control provides full range dimming to allow night operation in no- or low-light situations. The lower limit of the display brightness may appear as an inoperative tube during normal day-light operation. It is therefore advisable to check the BRT knob setting during preflight test.*

To ensure maximum display tube life, it is highly recommended that the display be operated at the lowest acceptable brightness level.

DH SET



To set the Decision Height, pull out and turn the DH knob. Turning clockwise will increase the Decision Height selected, turning counter clockwise will decrease the Decision Height. The DH set knob is variable rate, the faster the knob is turned the greater the change in a given amount of rotation. The Decision Height range is from "OFF" to 2,500 feet and will be displayed in one foot

increments up to 500 feet and then in 10 foot increments to 2,500 feet.

Once the desired DH is selected, push in the DH set knob to lock the selected DH altitude. If DH is set to OFF, the "DH" annunciation will not be displayed.

RALT TST



Pressing the RALT TST (Radio Altimeter Test) push button provides a discrete output to the Radio Altimeter initiating its self test function.

The height displayed on the EADI will depend on the type of Radio Altimeter installed. For details on this information refer to the Radio Altimeter Pilot's Guide of approve Flight Manual Supplement.

RADAR OPERATION

RADAR CONTROLS, (CP 466A & CP 466B)

The following section provides general operating information on EFS 40/50 radar control panels, CP 466A & CP 466B. Figure 2.3.1 shows the CP 466A used with an RDS 81, RDS 82 or RDS 82VP, RDS 84 or RDS

84VP, RDR 2000. Figure 2.3.2 shows the CP 466B used with an RDS 86, RDS 86VP or RDR 2100. For detailed information on the specific weather radar functions, refer to the appropriate radar pilot's guide.



Figure 2.3.1
CP 466A



Figure 2.3.2
CP 466B

Note: The CP 466A and B shown include the push buttons required for the Vertical Profile radars. For non-VP installations using the CP 466A or B the VP and two track buttons will not be present.

OFF-STBY-TST-ON

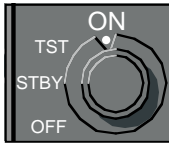

The rotary OFF-STBY-TST-ON knob selects the desired operating condition for the radar.

w **OFF**

Disables the ART (Antenna, Receiver and Transmitter) power supply. "OFF" is displayed below the NAV source annunciator on the radar mode line.

w **STBY**

After 30 seconds in this mode, the system is in a state of readiness. No radar transmission occurs, and the antenna is parked in the down position. "STBY" is displayed below the NAV source annunciator on the radar mode line, if a weather mode is selected.

w **TST**

Causes the test pattern to be displayed on the indicator, if a weather mode is selected. "TEST" is displayed below the NAV source annunciator on the radar mode line.

w **ON**

Selects the condition of normal operation, allowing for weather detection or other modes of oper-

ation. Depending on the selected mode of operation, WX, WXA or MAP is displayed below the NAV source annunciator on the radar mode line.

Note: If "ON" is selected on the CP 466 radar control panel, the radar Antenna, Receiver and Transmitter (ART) is operational. However, if a weather radar mode is not selected for display on one of the indicators the ART is placed in standby by the EFIS.

WX



Selects the weather mode (WX) when pressed. "WX" will be displayed below the NAV source annunciator on the radar mode line, if a weather mode is selected.

WXA



Selects the weather-alert mode when pressed. The magenta area of a storm will flash between magenta and black. "WXA" will be displayed below the NAV source annunciator on the radar mode line, if a weather mode is selected.

GND MAP



Places the radar in ground mapping mode of operation; disables weather-alert feature and acti-

vates gain control. "MAP" will be displayed below the NAV source annunciator on the radar mode line. (Magenta is not active in the GND MAP mode.)

LIGHTNING



o (Optional) Enables the Lightning display when pressed if a weather mode is selected for display.

VP



o (Optional) Once the desired azimuth is selected with the TRK button, press the VP button to enter the Vertical Profile mode of operation. The Vertical Profile Screen will appear. The weather mode of operation (WX, WXA or GND MAP) displayed in the lower left corner of the display will be the same as existed just prior to selecting VP. To select a different weather mode once in Vertical Profile, simply select the desired mode (WX, WXA or GND MAP) by pressing the appropriate button.

Note: A brief period of time will normally elapse before the display will "paint" the Vertical Profile "picture". This time delay is due to the fact that the radar continues its normal azimuth scan after the VP button is pressed.

The operation of scanning the antenna vertically (+/- 20 or +/-

30 degrees depending on the Radar) is referred to as taking a vertical "slice".

Once Vertical Profile is selected, the desired profile-azimuth angle may be changed in two degree increments by pressing and holding the appropriate TRK button. One of two things will happen when a TRK button is pressed: (1) If the radar's antenna is already profiling, the antenna will move in the two-degree increments, "slicing" in the direction determined by the TRK button; or (2) A "WAIT" annunciation will be displayed indicating that the radar's antenna will perform the desired "slicing" function as soon as the antenna returns to the last selected profiling-azimuth angle.

Depending on the software version of the RDS VP radar and the system installation, the antenna may also scan horizontally while in the VP mode. If the antenna is not sweeping vertically when the TRK button is pressed, a "WAIT" annunciation will be displayed until the antenna returns to the last vertical "slice" azimuth.

To terminate the Vertical Profile mode and return to the normal mode (horizontal scan), press the VP button. The radar system will retain its existing weather mode and return to horizontal scanning. A track line will be present on the screen for 15 seconds to indicate the location of the last profiling-azimuth angle.

Radar Operation

Beginning with EFS software version 09, a Split Screen mode is added to the VP button selection sequence immediately following the Vertical Profile mode. During this Split Screen mode the EFS will toggle the antenna between vertical and horizontal scans every 6 seconds, allowing both to be displayed simultaneously on the MFD. See Figure 4.4.4.

Note: *This Split Screen mode is an operational enhancement added to EFS 09 software that does not require any modification to the existing RDS 82VP/84VP/86VP/RDR 2000 weather radar systems. Since this feature was not part of the original design of these radars, the transition between horizontal and vertical scans is not synchronized to the antenna scan and will therefore occur at random scan positions.*

Horizontal (azimuth) and vertical (tilt) track lines are displayed on the MFD full time during the split screen mode to indicate the antenna scan position in each plane.

TRK



o (Optional) If the weather only mode is selected on the MFD, pressing the TRK button activates and slews a yellow dashed azimuth line. It also activates a digital display showing the number of degrees the azimuth line is located left or right from the nose

of the aircraft. In any other map weather presentation, only the yellow dashed line will be displayed.

For VP operations, the TRK button performs two functions. 1.) Prior to engaging VP, the appropriate button (left or right) is used to place the track line at the desired azimuth angle to be vertically scanned (sliced). When VP is engaged, the slice will be taken at the last position of the track line, whether it is visible or not. If the track line has not been selected after power has been applied to system and VP is engaged, the slice will be taken at 0 degrees (directly in front of the aircraft). 2.) When in VP mode, pressing the TRK will change the selected azimuth two-degrees left or right, depending on which button is pressed. Continuously holding the TRK button will result in the system “slicing” in two-degree increments, called continuous profile. Continuous profile is not used on the RDR 2000.

Beginning with EFS software version 09, the Drift Angle Track feature can be activated on the MFD by pressing both TRK buttons simultaneously. While active, this feature places the track line at the drift angle provided by an LNAV. The track line always indicates the azimuth angle at which a vertical scan is performed for VP operation.

Note: *Approximately 15 seconds after drift angle track is select -*

ed, the track line will disappear, however, the weather radar will continue to use the drift angle even though the track line is not displayed.

The EFS must be receiving valid drift angle information from an LNAV and have the drift angle bug displayed before the Drift Angle Track feature can be activated.

o A configuration option was added with software 09 to allow the drift angle bug to be displayed full time, in addition to the original option which displayed this bug only when the LNAV providing drift angle was selected as the primary nav sensor on EFS.

Drift angle track is de-activated and manual control returned by pressing either TRK left or TRK right buttons individually.

GAIN



Manual gain control becomes active when GND MAP is selected. In all other modes, gain is internally set.

PULL ARL



Only present when an RDS 86 or RDS 86VP is installed. Automatic Range Limit displays a blue area behind weather sys-

tems where weather detection is no longer possible because of attenuation.

TILT

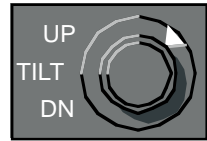

Permits manual adjustment of antenna tilt 15 degrees up or down to enable the pilot to analyze the weather presentation. The tilt angle is displayed below the NAV source annunciator on the radar tilt annunciator line.

If a CP 466A is installed, pull the Tilt selector knob, PULL STAB OFF, for "STAB OFF" operations. "STAB OFF" will appear on the Radar Fault/Warning line displayed below the NAV source annunciator just under the Antenna Tilt annunciation line.

If a CP 466B is installed, pull the Tilt selector knob, PULL AUTO, for Auto Tilt. If selected, an "A" will follow the tilt direction indication arrow preceding the internally calculated Auto tilt angle supplied by the ART.

**This page intentionally left blank.*

MFD OPERATION

MULTI FUNCTION DISPLAY CONTROL PANEL

The EFS 40/50 Multi Function Display Control Panel provides for display of a more meaningful variety of data than was previously accessible on EFIS MFD displays. In fact, the EFS 40/50 MFD may be used as a second EHSI by the pilot or copilot, providing them the ability to cross check their primary EHSI, preview or set up for a potential navigation scenario, and still function as a primary weather radar or LNAV map display.

The CP 469, MFD control panel, provides control of the selection of Nav source selection, display format and course selection. Starting with software release 08, the CP 469A MFD control panel replaces the CP 469 and provides additional control of Checklist, Joystick and TCAS functions. Weather radar control functions and mode selection are performed by the CP 466A/B, an independent weather radar control panel.



CP469



CP 469A
WITH CHECKLIST & JOYSTICK

Note: Software levels 04, 05, 06 and 07 do not support Checklist or TCAS functions.

CONTROL PANEL BUTTON OPERATIONS

Those push buttons which have common operation between the MFD and EHSI control panels, ED 461, CP 467 and CP 468, will function as defined in the section 2.1, EHSI Operation unless otherwise noted in this section. For detailed operational information on those buttons please refer section 2.1.

COURSE SELECT KNOB/BUTTON



The course select knob will function identical to, but independent of the one on the EHSI control panel, ED 461, CP 467 or CP 468, when the CRS SEL button is activated. This provides independent selection of course on the MFD referenced to the same or a different nav sensor.

If the CRS SEL button is not activated, the course select knob on the CP 469 will not be active. In this mode the MFD will obtain selected course data from the pilot EHSI control panel. In this mode the course on the EHSI and MFD will be synchronized, unless the selected sensor on the MFD is a LNAV providing DTK.

When the MFD course select knob is not active, a bar the color of the CRS annunciator will be placed above it. This will alert the

pilot that the MFD CRS knob is not active and is referenced to the pilot's EHSI selected course.

Example: $\overline{\text{CRS}}$ 135

HSI BUTTON



Will function identical to, but independent of, the one on the ED 461, CP 467 or CP 468. Beginning with software 07, an additional "Plan View" display format can be configured for presentation on the MFD. When configured, this display format is added to the end of the HSI button selection list provided in section 2.1.

Refer to section 2.1 EHSI OPERATION for detailed information.

ARC BUTTON



Will function similar to, but independent of, the one on the ED 461, CP 467 or CP 468. The MFD ARC button will allow the selection of an optional radar only MFD display. This display will not contain navigation or map data and is added to the end of the ARC button selection list provided in section 2.1.

NAV BUTTON



The NAV button may be configured at the time of installation and certification to operate in one of two methods.

o Configuration option number one will slave the MFD to the #1 EHSI. The NAV push button will cause the MFD to display either the same NAV sensor as displayed on the EHSI or the LNAV. When this configuration is selected the 1-2 push button allows selection between the on side and off side sensors. Once a side is selected, that side will remain the selected side until the 1-2 button is pressed again. This allows the pilot the ability to select the off side sensor to provide himself a constant visual cross comparison.

o Configuration option number two enables the NAV button to function identical to, but independent of, the one on the ED 461, CP 467 or CP 468. When this configuration option is selected the pilot can select any available nav sensor for display on the MFD independent of what is displayed on the EHSI.

1-2 BUTTON



If NAV push button configuration option number one is selected, where the MFD is slaved to the EHSI, the 1-2 push button allows the pilot to select between on side and off side NAV sensors. Unlike the 1-2 push button on the EHSI control panel, it selects which side will be displayed until pushed again. A press of the NAV push button will not cause a selected off side sensor to cycle back to an on side sensor as it does on the EHSI.

If NAV push button configuration option number two is selected, the 1-2 button functions identical to, but independent of, the one on the ED 461, CP 467 or CP 468.

BEARING #1 & #2 BUTTON



Will function identical to, but independent of, the one on the ED 461, CP 467 or CP 468.

Refer to section 2.1 EHSI OPERATION for detail information.

RANGE UP/DOWN BUTTON

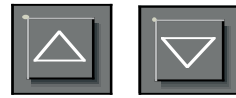

Will function identical to, but independent of, the one on the ED 461, CP 467 or CP 468.

Refer to section 2.1 EHSI OPERATION for detail information.

JOYSTICK

w **WAYPOINT ENTRY OPERATION**



When the joystick is interfaced to an EFS 40/50 system, it can be used to generate and move single waypoint on the display unit. These waypoints can then be entered into the KNS 81, KNS 660, KLN 88, KLN 90, or any other LNAV using an appropriate GAMA 429 interface. The KNS

MFD Operation

81 must have the graphic output bus.

With an LNAV, RNAV, (or KNS 81 configured as a NAV) selected for the primary nav sensor and during display of a NAV MAP on the MFD, initial movement of the joystick will create a waypoint cursor ahead of the aircraft on the half range ring at the current heading. This will be true for both HSI and ARC display formats. The cursor will be a standard white waypoint symbol. Movement of the waypoint will be in any of the eight directions commanded by the joystick. The rate of movement will start off slow and increase in speed in two steps. Return of the joystick to its center, off position at any time will reset the rate of movement to the slowest speed. The cursor location on the display screen and its rate of movement relative to the display screen will be independent of the display range selected. The cursor is not allowed to exit the compass. When an LNAV is selected as the primary navigation source, Lat/Lon coordinates of the cursor will be displayed in the lower center of the display. When a KNS 81 is the active primary navigation source, and it is not in the ILS mode, radial and distance of the cursor from the navaid in use by the KNS 81 will be displayed instead of Lat/Lon coordinates. The cursor position information can be transferred to the LNAV or KNS 81 that is selected as the primary navigation sensor, by pressing the ENTER button while

the cursor and its coordinates are displayed. The coordinates of the cursor will remain displayed for at least 10 seconds and disappear from the display within 15 seconds after activating the ENTER button. If the waypoint cursor is not moved for 20 seconds, it will disappear from view. The next time the joystick is moved, the cursor will re-appear in the same location on the display screen. However, a change of primary NAV sensor or display modes will reset the invisible cursor location to its initial starting position.

Note: *Systems with an MFD can have the joystick on the CP 469A MFD control panel or a stand alone joystick. Additional joysticks for the pilot or copilot normally will not be installed. Systems without an MFD may have up to two joysticks that are completely independent of each other; one for the pilot and one for the copilot. The pilot's joystick can create or move a waypoint only on the pilot's EHSI, and any waypoint created by the pilot can only be loaded into the #1 RNAV or #1 LNAV. Likewise, the copilot's joystick can create or move a waypoint only on the copilot's EHSI, and any waypoint created by the copilot can only be loaded into the #2 RNAV or #2 LNAV.*

w PLAN VIEW OPERATION (available with 07 and higher)

Plan View will be available in the HSI key selection sequence

immediately following “DG MODE”. In addition to selecting the plan view display mode, the operator must be using a nav source which will provide flight plan information like FMS, GPS, and LORAN sensors.

If joystick is not available, the center of the screen will represent the aircraft present position when plan view mode is entered, and the map may not be moved from this reference. Range could be changed using the range buttons. When a joystick is available, it will control the flight plan view relative to the aircraft present position. Pressing the “ENT” button will reset the display where the aircraft is displayed in the center of the display.

w **CHECKLIST OPERATION** (available with 08 and higher)

In the Checklist mode, the Joystick commands will be limited to four positions: UP, DOWN, LEFT and RIGHT. The 45° commands will be ignored.

A down push on the joystick will advance the cursor checklist line. A down push at the bottom of a checklist page will advance the cursor to the next page if available. Continuous downward pushes will wrap the cursor within a checklist level.

An up push on the joystick will move the cursor up one checklist line. An up push at the top of a checklist page will move the cursor to the previous page if avail-

able. Continuous upward pushes will wrap the cursor within a checklist level.

A right push on the joystick will move the cursor to the top of the next checklist page. Continuous right pushes will wrap the cursor to the top of the next page within the list.

A left push on the joystick will move the cursor to the top of the previous checklist page. Continuous left pushes will wrap the cursor to the top of the previous page within the list.

ENT BUTTON



w **WAYPOINT** **ENTRY OPERATION**

In the map mode the cursor position information can be transferred to the LNAV or KNS 81 that is selected as the primary navigation sensor, by pressing the ENTER button while the cursor and its coordinates are displayed. The coordinates of the cursor will remain displayed for at least 10 seconds and will disappear from the display within 15 seconds after the ENTER button is pressed.

w **PLAN VIEW OPERATION** (available with 07 and higher)

In the Plan View mode the enter button will be used to reset the aircraft in the center of the display.

w **CHECKLIST OPERATION** (available with 08 and higher)

In the Checklist mode the enter button will generally function to check items in the list. The checklist was designed such that the pilot can complete the entire checklist by using only the enter button.

Normally, pressing the 'ENT' button will cause an unchecked checklist line to be checked and the cursor to advance to the next unchecked line. At the end of a page pressing the 'ENT' button will cause the cursor to advance to the next page (if available) and to check the first unchecked line on that page. If no unchecked items exist between the cursor position and the end of the list, the cursor is placed on the first unchecked page which referenced the specific list.

TEST/REFERENCE



Will function identical to, but independent of, the one on the ED 461, CP 467 or CP 468.

With checklist active, this button will cause a checklist "help" page to be displayed on the MFD.

Refer to section 2.1 EHSI OPERATION for detailed information.

CHECKLIST SELECT



(available with 08 and higher)

This button is not functional in Software 04, 05, 06 or 07.

Pressing the checklist button will display the root page of the checklist. If an emergency discrete is active, pressing the checklist button will display the emergency page

TCAS ONLY SELECT



(available with 08 and higher)

This button is not functional in Software 04, 05, 06 or 07.

The TCAS ONLY button will toggle the MFD display between the TCAS only presentation and the previously selected mode.

TERRAIN SELECT

(available with 14 and higher)

This button is not functional in Software 04, 05, 06, 07, 08, 09, 10, 11, 12 or 13.

The TERRAIN SELECT button will toggle the MFD display between the Terrain presentation and the previously selected weather mode.

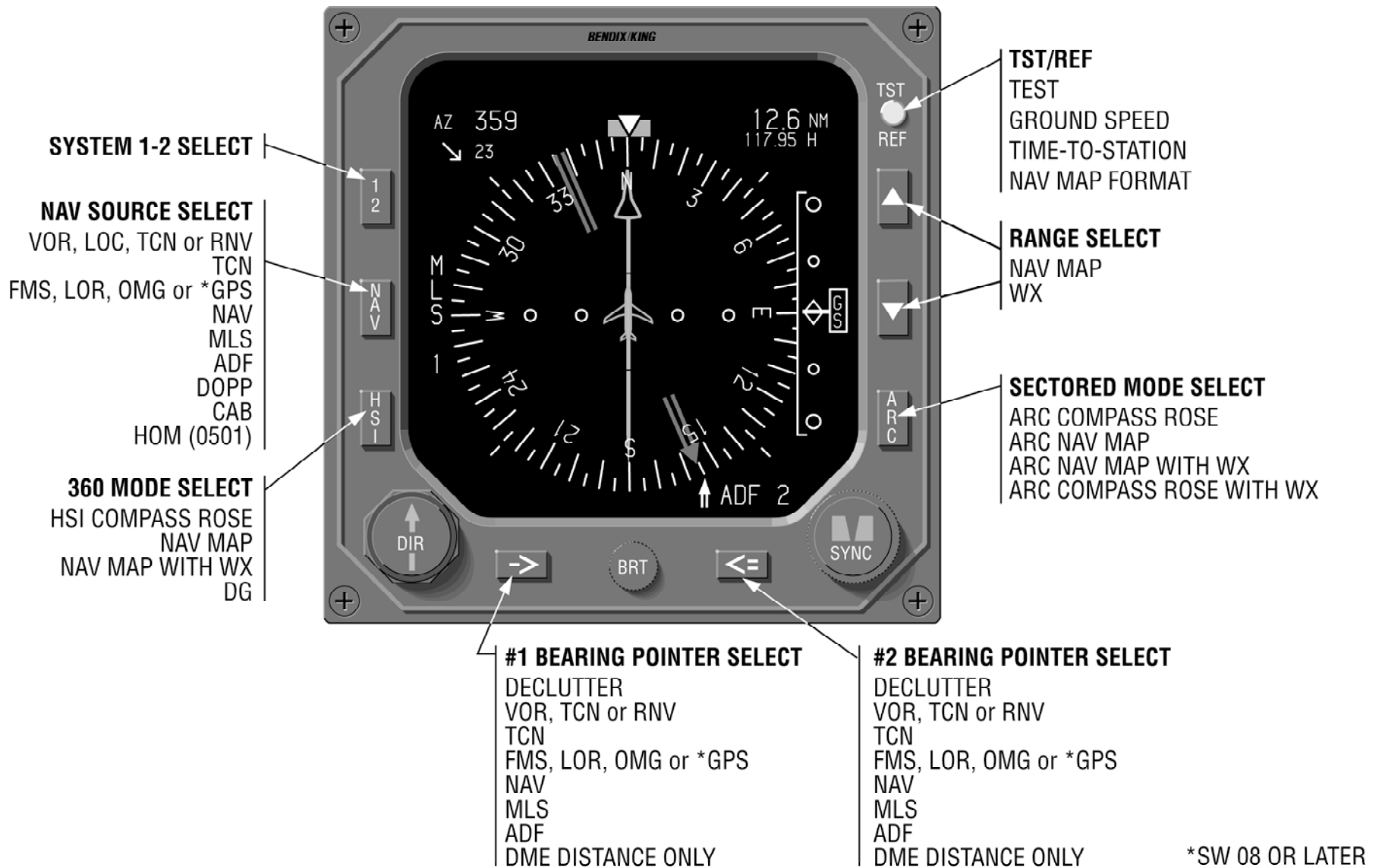

Figure 3.1
 ED 461 EHSI CONTROL PANEL OPERATION

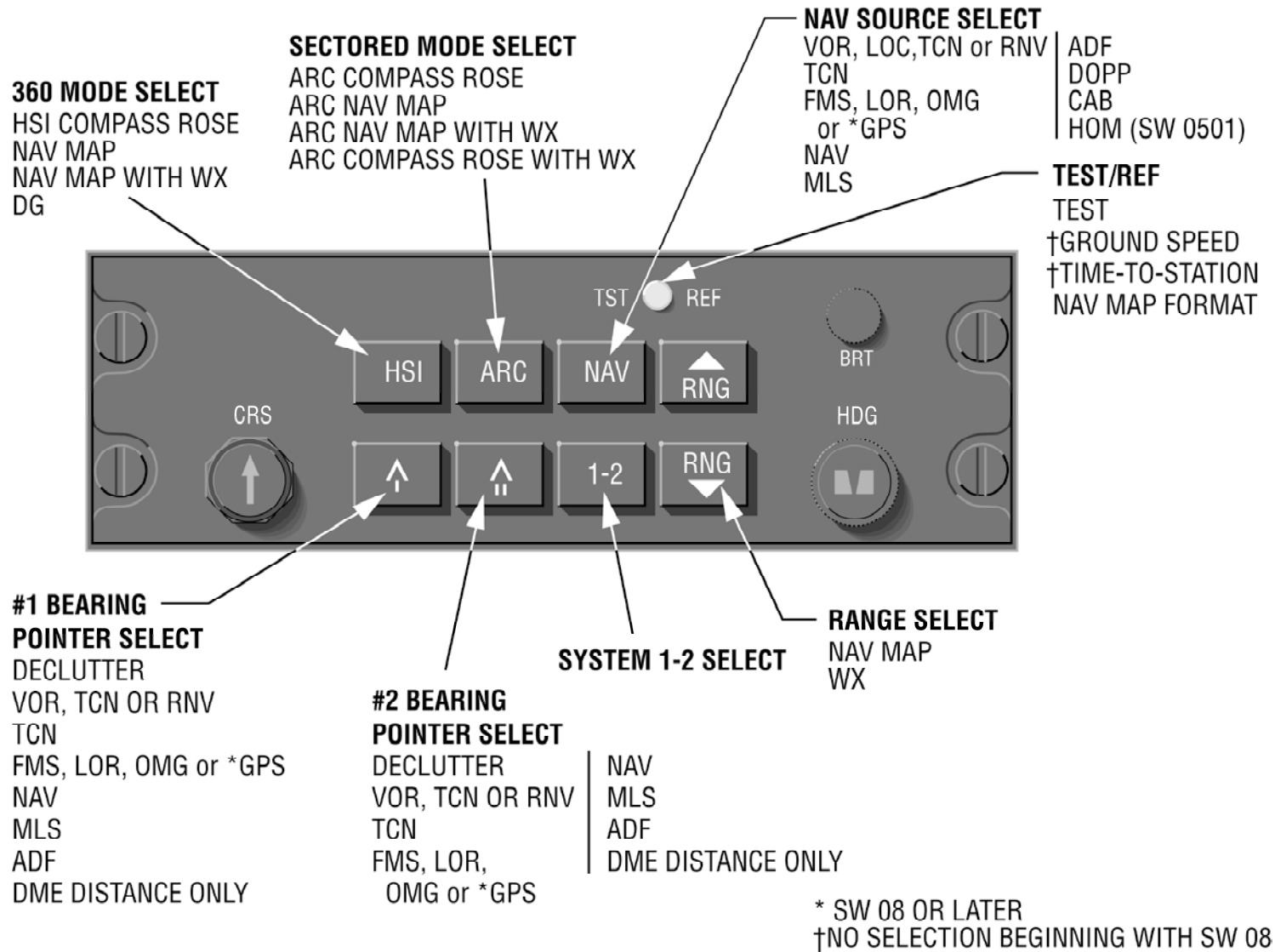

Figure 3.2
 CP 468 EFIS CONTROL PANEL OPERATION

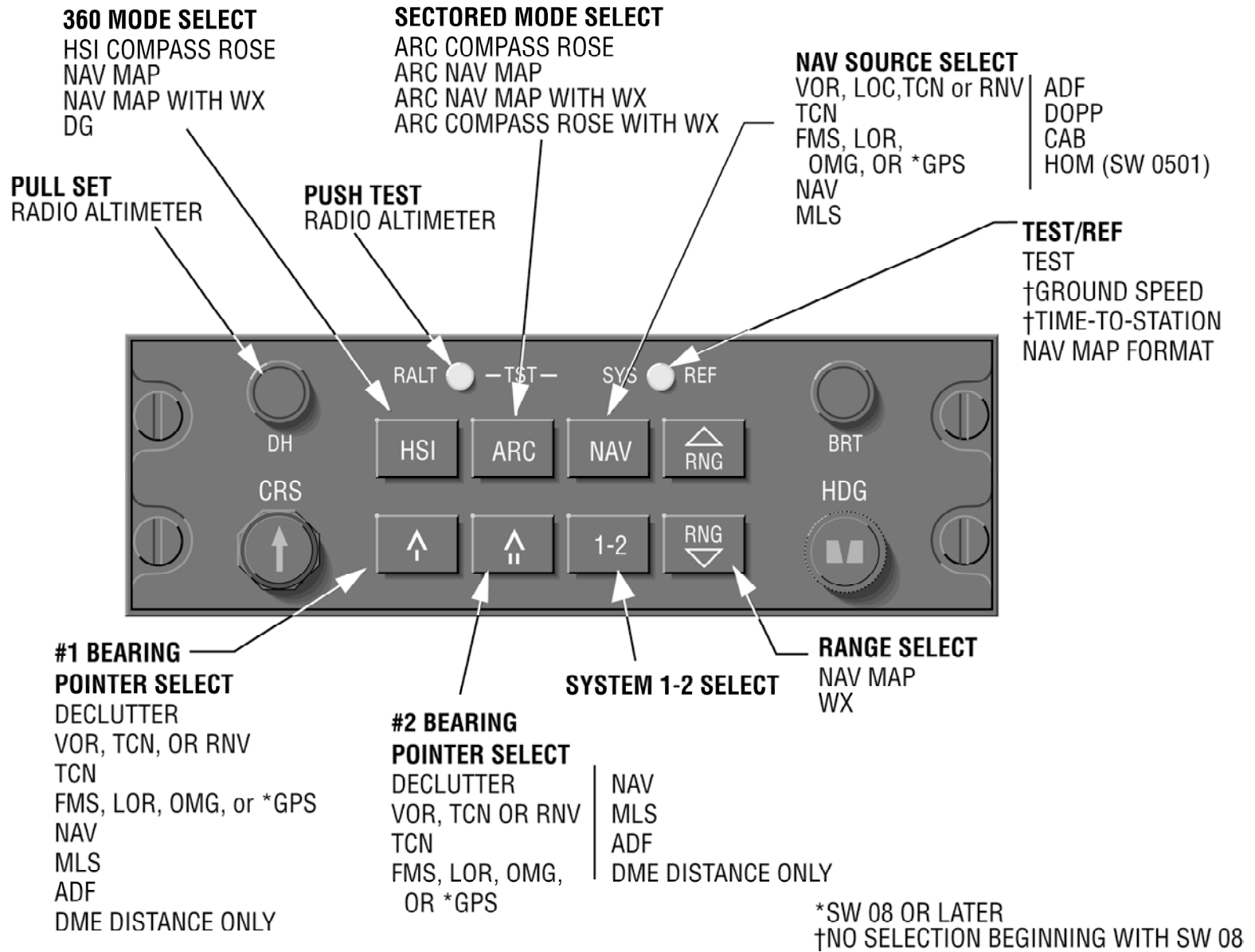

Figure 3.3
 CP 467 EFIS CONTROL PANEL OPERATION

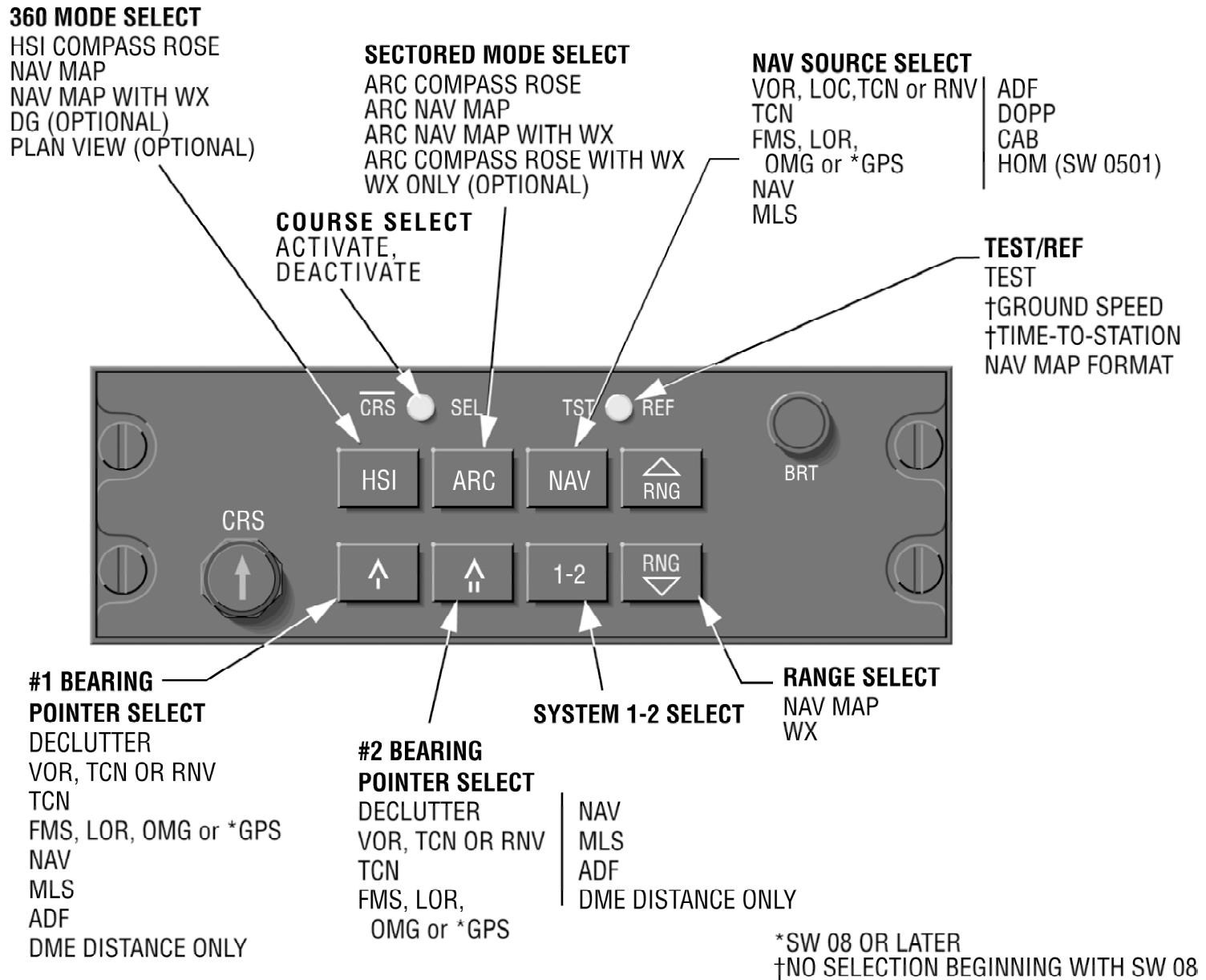

Figure 3.4
 CP 469 MFD CONTROL PANEL OPERATION

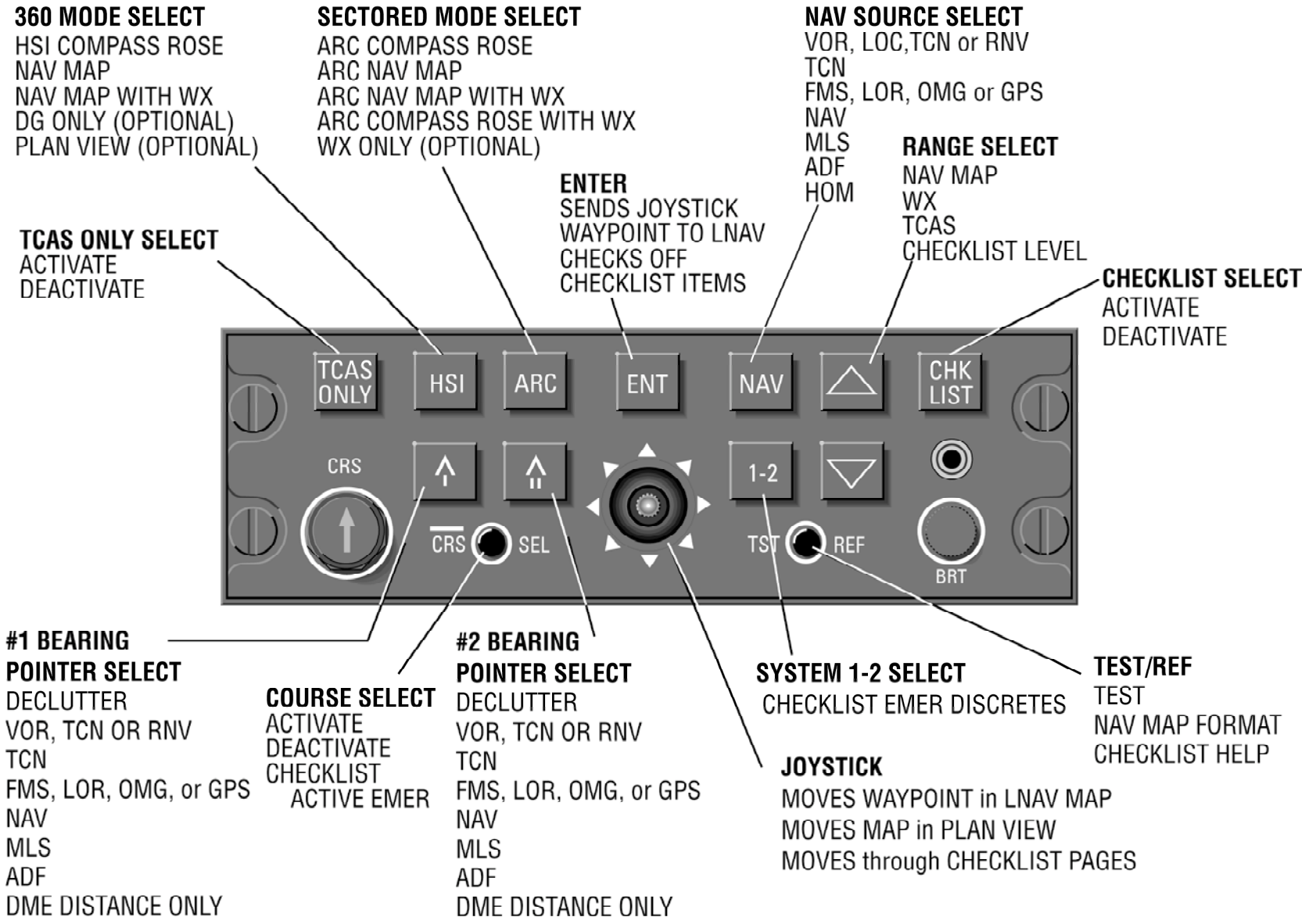

Figure 3.5
 CP 469A MFD CONTROL PANEL OPERATION

EHSI DISPLAYS

EFS 40/50 COLOR STANDARDS

The EFS 40/50 uses a defined color set which aids the pilot in interpreting displayed information. A brief summary of the color set is as follows:

Warnings	Red
Cautions/Abnormal Source	Yellow
Scales and associated figures	White
On-side approach and navigation data	Green
Cross-side NAV data	Yellow
On-side non-approach navigation data (LNAV)	Cyan
On-side commanded data	Green
Cross-side commanded data	Yellow
Selected heading, DME HOLD annunciation	Orange
Selected source	Matches NAV data color
Selected active route/flight plan	Green
Cross-side selected active route/flight plan	Yellow
Held DME distance display	White

For an example of the color usage, refer to figure 4.1.3 at the back of this section, Typical EFS 40/50 EHSI Color Displays.

STANDARD EHSI DISPLAYS

Refer to Figures 4.1.5 and 4.1.6 while reviewing STANDARD EHSI DISPLAYS.

NORMAL COMPASS CARD

360° rotating white compass scale indicates aircraft heading referenced to white triangular heading index (lubber line). The compass scale is divided in 5-degree increments with the 10-degree divisions being approximately twice as long. Fixed

45-degree index marks are adjacent to the compass scale.

Free DG (directional gyro) operation will be annunciated by a yellow FDG (or FHDG) to the left of the lubber. The Free mode annunciation will only be supported in installations with an ARINC 429 AHRS (Attitude Heading Reference System) that supports the Free DG (directional gyro) mode of operation via the digital data bus.

Note: Software release 06 changed the DG annunciation to HDG to better describe the variety of heading sources that may be interfaced with the EFS 40/50, ie. INS, AHS and conventional gyros.

Dual selectable compass inputs are provided for. If a second compass system is installed, the cross-side source is selected by means of a remote mounted switch. Once the alternate compass source has been selected, a yellow DG1 (HDG1) or DG2 (HDG2) will be displayed to the left of the lubber line.

In a dual EFS 40/50 installation with software release 04 or 05, if both systems use the same heading source, annunciations will appear on both EHSI's alerting the pilots they have the same source selected. The EHSI that is using its normal heading source will annunciate a yellow "DG" with a yellow box around it to indicate that its primary heading source has been selected for use on the other EHSI. The EHSI that is using its alternate heading source will annunciate a yellow "DG1" or "DG2" as applicable with a yellow box around it to indicate the heading source being used is the same one being used by the other EHSI. For example, if the co-pilot were to select his alternate heading source, heading #1, "DG1" would appear with a box around it on the co-pilot's EHSI and DG would appear with a box around it on

the pilot's EHSI.

In a dual EFS 40/50 installation with software release 06 and above, if both systems select the same heading source, a yellow "HDG1" or "HDG2" with a yellow box around it will appear on both EHSIs alerting the pilots that they have the same source selected.



Figure 4.1.1
SAME HEADING SOURCE
SELECTION

When two compass sources are available, the two inputs are compared for agreement. If the two inputs do not fall within 6-degrees of each other while in level flight, a yellow comparison warning, HDG under a double-ended arrow, will be annunciated to the right of the lubber line. See figure 4.1.5, EHSI SYMBOL DEFINITION.

NAVIGATION SOURCE ANNUNCIATION

A vertical three- or four-letter alphanumeric readout located on the left or right side of the display, depending on vertical scale side selection, indicates the system selected as the primary navigation sensor.

For dual sensor installations the cross-side navigation system may be selected by pressing the 1-2 push button. Example: pilot

selecting co-pilot's navigation system or co-pilot selecting pilot's navigation system. The 1-2 push button will not be active if the system configuration does not support two of the same type NAV sensors.

Green annunciations indicate an on-side approach NAV system or an enroute NAV system which has been approved for approach use is being displayed. Yellow indicates the cross-side system has been selected. Cyan annunciations apply to on-side non-approach LNAV systems. These color codes apply to the NAV source annunciator, CRS pointer, deviation bar, CRS line in MAP mode, CRS, distance, ground-speed, time-to-station, drift angle pointer and vertical deviation pointer.

Software release 06 incorporated the ability to interface with the TACAN version of the KNS 81 and annunciate TCN when the KNS 81 is in the TACAN mode of operation.

If both sides select the same navigation source, (i.e., pilot and co-pilot select VOR 2) a yellow box is placed around the navigation source annunciator on both EHSI's.

If both sides select their respective cross-side navigation source (i.e., pilot selects system 2, co-pilot selects system 1) then both NAV source annunciators will be yellow with no yellow box.

Note: Same source annunciation rules also apply to the heading source.

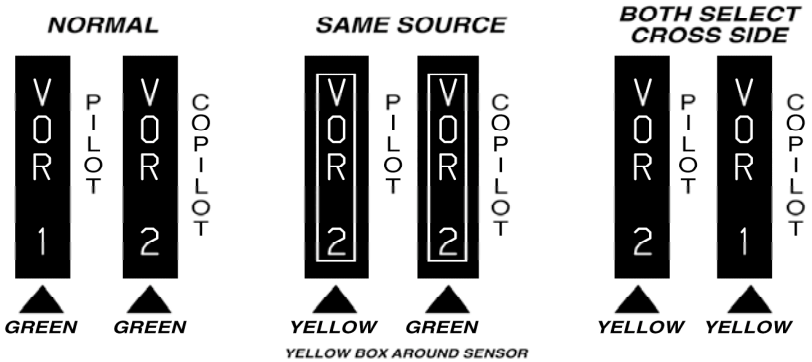

Figure 4.1.2

SAME NAVIGATION SOURCE SELECTION ANNUNCIATION

SYMBOLIC AIRCRAFT

The orange symbolic aircraft provides a visual reference of the aircraft present position in relationship to the deviation bar.

Note: Starting with software 08 a configuration option is available for the display of Fixed wing or Rotary Wing symbolic aircraft.

HEADING SELECT “BUG”

A notched heading bug is manually rotated around the compass scale by the heading select knob on the control panel. In the 360-degree compass mode a full time digital readout of the selected heading is displayed below the vertical deviation scale position. In the ARC mode, a digital heading readout is displayed when the heading bug is not completely in view. The digital readout will be positioned just inside the compass scale on the side nearest the heading bug. Once set, the heading bug rotates with the compass card. The heading bug is used to indicate desired heading and provides selected heading reference for autopilot steering.

A RED X will be drawn through the heading bug if there is a heading select knob failure on the EFS 40/50 control panel.

Software release 06 added the options, selectable at the time of installation and certification, to select one of three heading bug and digital readout color choices:

- o Orange
- o Cyan
- o Magenta

Prior to software 06, the heading bug and selected heading readout are always orange. The heading bug is not displayed in MFD only installations. This became an EFS system configuration option with software 09.

COURSE SELECT

The CRS control knob rotates the course pointer about the compass scale and sets digital course readout. Once set, the course pointer rotates with the compass card. The selected course indicates desired navigation course to be flown. Depending on the LNAV (long range navigation) installed, the course pointer may automatically be positioned to the DTK (desired track) when LNAV is selected as the primary sensor. When LNAV is the selected sensor and DTK is displayed, the EFS 40/50 course select knob is disabled.

In the upper left corner of the display, an alphanumeric readout annunciates the letters CRS and indicates the selected navigation course in degrees. When in a NAV map display mode, the course pointer will not be displayed, the alphanumeric readout will be the only reference for the selected course.

Note: *Desired track readout (DTK) generated by an LNAV system replaces (CRS) in LNAV mode. Some LNAV systems may display CRS or DTK depending on the selected mode. MLS may display AZ (azimuth) or BAZ (back azimuth) depending on the selected mode.*

Systems with Software release 05 retain (remember) the manually selected course, as set by the CRS knob, when the selected

primary NAV sensor is sequenced through the LNAV position. In previous software releases, once the LNAV sensor was displayed, its CRS or DTK would become the selected course, requiring the CRS to be reset when another primary Nav sensor was selected.

This change will allow an ILS inbound course to be selected prior to the completion of an LNAV flight leg that will be followed by an ILS approach.

In the event of a heading failure, the course pointer head and tail are removed and the course deviation scale is fixed in a hori-

zontal position, providing standard course deviation information (CDI) referenced to the digital CRS selected. A RED X will be drawn through the CRS annunciation if there is a course select knob failure. In the event the selected course or desired track received from the LNAV becomes invalid, a RED X will be drawn through the digital readout.

Note: *The above heading failure mode does not apply when ADF is the primary NAV sensor. (ADF D-Bar is heading dependent and is non-operational without valid heading.)*

LATERAL COURSE DEVIATION SCALE

The course deviation scale, two white dots evenly spaced on both sides of the symbolic aircraft, provides a reference for the course deviation bar to indicate the center line of the selected

navigation or localizer course in relation to the symbolic airplane.

The following represents the deviation scale for different navigation sources.

Note: *Depending on the type of LNAV installed, the Lateral Deviation may be different. GPS lateral deviation scale is for TSO C129 capable units only. SW 15 and later accepts C145/C146 equipment variable deflection values.*

MODE	ANGULAR DEV (DEGREES)	LINEAR DEV (MILES)
VOR/TAC	1 dot 5.0 deg	
	2 dots 10.0 deg	
ADF	1 dot 7.5 deg	
	2 dots 15.0 deg	
LNAV or RNAV		1 dot 2.5 NM
		2 dots 5.0 NM
LNAV or RNAV APPR		1 dot 0.625 NM
		2 dots 1.25 NM
GPS ENROUTE		1 dot 2.5 NM
		2 dots 5.0 NM
GPS TERMINAL		1 dot 0.5 NM
		2 dots 1.0 NM
GPS APPROACH		1 dot 0.15 NM
		2 dots 0.3 NM

LATERAL DEVIATION SCALE
(Aircraft Displacement)

LATERAL COURSE DEVIATION BAR

The course deviation bar represents the center line of the selected navigation or localizer course.

If invalid or failed primary NAV sensor data is received the course deviation bar and scale are removed and a RED X annunciated.

Beginning with software 09, the deviation bar and scale are decluttered without displaying a RED X when the deviation information is provided in ARINC 429 format with a status of NO COMPUTED DATA (NCD). The RED X will still be displayed if the data is missing or invalid.

TO/FROM INDICATOR

A white filled triangle near the center of the EHSI pointing toward the head ("TO") or tail ("FROM") of the course pointer indicates whether the selected course is TO or FROM the station or waypoint. The TO/FROM annunciator is not displayed during ILS/MLS operation or when an invalid NAV signal is received.

DISTANCE, GROUND SPEED and TIME-TO-STATION

The EFS 40/50 provides up to three distance displays — one for each selected navigation source (if distance information is available from that source).

The readout for the primary NAV

source is shown in the upper right corner. This readout will also show aircraft groundspeed and Time-to-Station/Waypoint. Both are displayed simultaneously with software 08 and higher.

The distance readout for navigation source 1 (the single-bar bearing pointer) is in the lower left corner below the navigation source annunciator. The readout for navigation source 2 (the double-bar bearing pointer) is in the lower right corner below the navigation source annunciator.

These readouts show distance (in nautical miles) to the selected station when in VOR, TACAN, ILS or MLS mode. When in LNAV, RNAV or GPS mode, distance to the waypoint is shown.

Each of these three distance readouts is displayed in the same color as the source annunciator and pointer with which it is associated.

With software 04/05/06/07 the EFS 40/50 will display ground speed up to 999 KTS, Time-To-Station up to 511 minutes and distance up to 4,095 nautical miles. In most cases, the DME will be the limiting factor in displayable data.

With software 08 and higher, the EFS 40/50 will display ground speed up to 999 KTS, Time-To-Station up to 8:31 (H:MM universal format) and distance up to 4,095 nautical miles. Time-To-Station is displayed immediately below and at the same time as

ground speed. In most cases, the DME will be the limiting factor in displayable data.

When DME HOLD is selected, the distance displayed is white in color. "H" follows GS/TTS field (GS field after software 08) in the upper right corner. During HOLD the displayed distance probably will not be associated with the selected bearing pointer. For more information on DME HOLD, refer to the DME HOLD section which follows.

o The bearing sensor selection function offers an optional DME-only display feature in the cycle. If the DME-only option was selected at the time of installation and certification, DME #1 and #2 information may be independently selected for display in the bearing pointer information area without displaying a bearing pointer.

To annunciate operational Distance Measuring Equipment (including those associated with an RNAV or LNAV) which has not acquired lock on to the selected station, dashes of the same color as the sensor annunciator will be placed in the distance data field. If the equipment has failed or information is not being received by the EFS 40/50, the dashes will be Red. In both cases the NM annunciation will remain and the KT/TTS will be removed if normally displayed.

DUAL MULTI CHANNEL DME INSTALLATIONS

o Software 07 incorporated the capability to interface with a variety of multi channel DME, VOR/ILS and MLS installations, and perform automatic reversion in the event of a failed DME sensor in certain installations.

For those installations supporting the automatic reversionary mode, the system can experience a DME failure without the pilot or copilot losing the normal distance presentation. For example, if the number one DME, whose primary job is servicing the number one VOR/ILS, failed, the symbol generator would look to DME number two for VOR/ILS DME number one distance information. If the information was present, a yellow boxed DME 2 would be displayed in the upper right hand corner of the number one EHSI and MFD. This alerts the pilot he is now getting distance information from the copilot's DME. A green boxed DME 2 is placed in the same location on the number 2 EHSI alerting the copilot the pilot is getting distance information from his DME. These boxed DME annunciations use the same display field as the Time-to-station (or Time-to-way-point) after software 08. The abnormal DME annunciation has priority over TTS/TTW.

Note: *The variety of the various DME installations is numerous, and therefore may be necessary to refer to the aircraft flight manual supplement for specific operation of a given installation.*

DME HOLD

When DME HOLD is selected, the DME distance and annunciator color will change to white and remain that color until HOLD function is released. The sensor identifier (ADF, VOR ILS, etc) shall retain the original assigned color, this color difference indicates there may be no relationship between the two fields. The HOLD function is additionally indicated by an orange letter “H” which is displayed directly below and to the right of the distance information. DME groundspeed and time-to-station will not be displayed when DME HOLD is active. If the DME provides ARINC 429 frequency information, the HELD FREQUENCY will be displayed in white where groundspeed was previously displayed.

DME HOLD for BEARING POINTER/DME #1 and BEARING POINTER/DME #2 will operate as described above, but HELD FREQUENCY information will not be displayed.

Once the DME is placed in HOLD, its distance will continue to be displayed and will not be affected when bearing pointers and primary NAV sensors are changed unless the selected sensor provides range information such as an LNAV, RNAV or MLS. In these cases, the held information will be replaced with the selected sensor’s range information.

The bearing pointer sensor annunciators located in the lower right and left corners of the display also provide range information when the selected bearing sensor has associated range. If the associated range information is provided by DME, then the range information and NM annunciation will change from the normal light blue or magenta color to white and be followed by an orange “H” when HOLD is activated. If an ADF is the selected bearing pointer sensor and the DME assigned to that side is placed in HOLD, the large ADF annunciation will reduce in size as the white held DME range information and orange “H” is displayed below it.

Please note that the range information being displayed is not referenced to the ADF, but to whatever channel the DME was tuned to when the pilot placed it in HOLD.

DME HOLD will not function when an LNAV or RNAV is the selected sensor, and is not allowed when MLS or TACAN is the selected primary sensor. The associated distance field is used to display waypoint distance or distance to the MLS or TACAN station.

Note: *It is important to remember that once a DME is placed in HOLD it probably is not referenced to any VOR/ILS sensor being displayed. Hold removes the dependency of*

the DME to the VOR/ILS control head. It is, therefore, up to the pilot to recognize that when the DME distance information color changes to white and the orange "H" is displayed, the distance presented is probably not paired to the VOR/ILS control head frequency.

Hold is a pilot selected mode of operation for the DME. Once the pilot selects hold, it is the pilot's responsibility to remember where the DME is HELD.

DME and DME HOLD operation may vary greatly from installation to installation. This variation in operation is directly dependent upon the number and types of DME installed. To best understand how these two functions work in a particular installation, refer to the aircraft flight manual supplement or contact the installing agency for a detailed explanation.

BEARING POINTER

The rotating light blue single bar #1 Bearing Pointer points in the direction of the selected bearing sensor ground station (or waypoint when in the LNAV or RNAV mode).

The rotating magenta double bar #2 Bearing Pointer performs the identical function for #2 bearing sensor systems.

If the selected bearing sensor is

not receiving valid data, the Bearing pointer assigned to that bearing source will not be displayed and a RED X will be drawn through the selected bearing source annunciator at the bottom left or right of the display. The associated distance data will remain displayed if valid.

If the compass card is MAG (magnetic) referenced, TRUE bearing sensor pointers, such as LNAV, may be displayed if valid mag var (magnetic variation) is provided to the EFS 40/50. In this case, the TRUE sourced bearing pointer information will be converted to MAGNETIC reference.

If the compass card is TRUE referenced, MAGNETIC bearing sensor pointers, such as VOR and ADF, may be displayed if valid mag var (magnetic variation) is provided to the EFS 40/50. In this case, the MAGNETIC sourced bearing pointer information will be converted to TRUE reference.

In most cases mag var is provided by an LNAV. In a single LNAV installation the EFS 40/50 will use the single mag var source to compute display correction for both number 1 and number 2 sensors. In dual LNAV installations with an LNAV selected as the primary nav source, that LNAV is the only source of mag var. In dual LNAV installations with a primary nav source other than an LNAV, the mag var

will be supplied only by the on-side LNAV with software prior to 08, but beginning with SW 08, the off-side LNAV is used as a secondary source of mag var information.

If valid mag var is not available, those bearing pointers displayed with mag var correction will be removed and a RED X is drawn through the sensor annunciator in the lower right or left corner.

In the event a heading failure occurs, a heading flag will be displayed to the pilot, the compass card will remain active to follow input from the compass system. Bearing pointer information will continue to be displayed. The EFS 40/50 will process the bearing information and present all bearing pointer information except ADF referenced to the compass card, the ADF bearing pointer will be relative to the nose of the aircraft and lubber line on the EHSI.

EXAMPLE:

Note: Refer to figure 4.1.4 BEARING POINTER OPERATION WITH LOSS OF HEADING when reviewing this example.

Aircraft actual mag heading is 030 degrees, but EHSI compass is failed and displays an incorrect heading of 090 degrees — 60 degrees greater than actual. Bearing pointer number one is referenced to a VOR station and is pointing to

120 degrees on the compass card. Bearing pointer number two is referenced to an ADF station and is pointing to 180 degrees on the compass card.

When interpreting bearing pointer number one in this example, remember that VOR, TCN, RNV, OMG, FMS, GPS or LOR indications are referenced to the compass card. Therefore, since bearing pointer number one is pointing to 120 degrees on the compass card, the correct course to the VOR is 120 degrees. Likewise, since the tail of bearing pointer number one is on the 300-degree mark on the compass card, the correct bearing from the VOR is 300 degrees.

Caution: Do not assume that the course to the VOR is 30 degrees to the right of the aircraft nose. Although the bearing pointer is pointing 30 degrees to the right of the lubber line, you must remember that the pointer in this instance is referenced to the compass card — not the lubber line or symbolic aircraft.

When interpreting bearing pointer number two in this example, remember that ADF indications are referenced to the lubber line and the symbolic aircraft. They are not referenced to the compass card. The compass card can be used only to help you determine ADF relative bearing.

Likewise, the tail of the pointer is at 360. Indicated heading on the compass card is 090. So relative bearing is 90 degrees left. Actual heading is 30 degrees. So actual bearing from the NDB is 90 degrees to the left of 30 degrees, which is 300 degrees.

One other thing to note about ADF indications with failed heading is this: The ADF bearing pointer points to the station relative to the symbolic airplane. Since the bearing pointer in the example is pointing straight off the right wing of the symbolic airplane, you may conclude the station is straight off the right wing of the actual airplane.

MAGNETIC/TRUE HEADING ANNUNCIATIONS

To the left of the lubber line a white "T" will be displayed when the compass card is in the true mode of operation or left blank when in magnetic mode.

Magnetic compass heading is automatically displayed unless True heading is selected by a remote switch or when the selected primary NAV sensor is an LNAV and it selects the True mode of operation. Valid mag var must be present before True heading can be selected by the LNAV.

RADIO ALTITUDE

Beginning with software version 07, radio altitude provided by a compatible radio altimeter may

be displayed on the EHSI in installations that do not include EADI displays. (The SG must be configured for EHSI only operation). This radio altitude will be displayed in white with a "ft" suffix near the bottom of the EHSI on the side opposite the selected NAV sensor annunciation. Decision height (DH) select and DH alert annunciations are not provided on the EHSI.

The displayed altitude range is from -20 ft to 990 ft in 5 ft increments below 100 ft and 10 ft increments above 100 ft for EFS software 07 and 08. Beginning with 09 software, 5 ft increments are provided up to 500 ft.

The radio altitude is decluttered at or above 1000 ft. Three red dashes will be displayed when the radio altitude is invalid and three white dashes are displayed for values below -20 ft or data with a No Computed Data (NCD) status.

Note: *20 ft is the minimum altitude displayed when a KRA 10A is the configured radio altimeter.*

GLIDE SLOPE/VERTICAL NAVIGATION

When the selected primary NAV sensor is ILS, MLS or LNAV with VNAV selected, a stationary white vertical deviation scale will appear on the right or left side of the EHSI display as configured at the time of installation and certification. This scale provides a ref-

erence for the vertical deviation pointer. The deviation pointer moves in relation to the scale to indicate glide path center with respect to aircraft position.

When the selected primary NAV sensor is an on-side ILS, MLS, or LNAV in the approach mode, the vertical deviation pointer is green in color. If an off-side sensor is selected for display, the deviation pointer changes to yellow alerting the pilot that he has selected other than his on-side NAV sensor. A cyan pointer is displayed for VNAV provided by an on-side LNAV in the enroute mode. Full scale VNAV deviation represents ± 1000 feet when provided by an LNAV in the enroute mode. Prior to 08 SW, full scale VNAV deviation represents ± 500 feet when provided by an LNAV in the approach mode, however after 08 SW, this scaling can be configured to be ± 1000 , ± 500 , ± 250 , or ± 200 feet.

If the selected sensor is ILS, a "GS" will be displayed in the vertical pointer. When MLS is the selected sensor, this annunciation will be "GS" for SW 06 and 07, but beginning with SW 08, either "GS" or "GP" (for Glide Path) may be annunciated. When MLS is the selected sensor, the selected glide path angle is displayed above the glideslope deviation scale. If VNAV is displayed "FT" (feet) or "ANG" (angle) will be annunciated above the vertical deviation scale. "VN" will be annunciated if the selected sensor is an LNAV with VNAV selected. Beginning

with SW 15, during a GPS approach the vertical scale will display the vertical annunciator as "GP".

Additional configuration options selectable at the time of installation and certification:

- o **Declutter GS on Back Course**, allows the vertical deviation scale to be in view at all times or only when the selected course is within 105 degrees of the aircraft heading.

Vertical Scale Side, allows the vertical deviation scale to be displayed on either the:

- o Right or
- o Left side of the EADI and EHSI display.

VNAV Approach Mode Scaling, a configuration option added by software 08, allows the following values for a full scale VNAV approach deviation.

- o 1000 feet
- o 500 feet
- o 250 feet
- o 200 feet

Vertical Pointer Type, incorporated in software 06, allows the vertical pointer to be displayed as one of three options

- o 
- o 
- o 

Vertical Pointer Annunciation for MLS

A configuration option added by software 08, allows the choice of two pointer annunciations when an MLS is the selected primary NAV sensor.

- o GS
- o GP

For a particular installation, refer to the Aircraft Flight Manual Supplement to determine the EFS 40/50 VNAV scale factors.

If invalid or failed glide slope or VNAV data is received, the vertical deviation bar and scale are removed and replaced with a RED X annunciation.

Beginning with software 09, the vertical deviation bar and scale are decluttered without displaying a RED X when the deviation information is provided in ARINC 429 format with a status of NO COMPUTED DATA (NCD). The RED X is still displayed for invalid or missing data.

WIND VECTOR

o When the aircraft is equipped with the appropriate LNAV equipment, an optional full time wind vector indicating approximate wind direction and speed may be displayed in white in the upper left corner below the selected course. Wind vector information will be available only when valid data is provided by the LNAV. The information provided by this vector is advisory only. It is NOT intended for use during approach as critical flight data because it

will become inaccurate during altitude changes.

In single LNAV systems the wind vector data may be displayed on all EHSI displays. In dual LNAV installations with an LNAV selected as the primary nav source, that LNAV is the only source of wind vector data. In dual LNAV installations with a primary nav source other than an LNAV, the wind vector data will be supplied only by the on-side LNAV with software prior to 08, but beginning with SW 08, the off-side LNAV is used as a secondary source of wind vector information.

***Note:** If the selected LNAV is configured as a Crouzet Omega, the wind vector will be displayed as the standard meteorological wind symbol.*

DRIFT ANGLE POINTER (LNAV only)

The drift angle pointer is an optional hollow cyan (green or yellow in approach mode) triangular pointer which is generated by some LNAVs and rotates about the outside of the compass scale. Referenced to the lubber line, the drift angle pointer represents drift angle left or right of the aircraft heading. With respect to the compass scale, the drift angle pointer represents aircraft actual ground track.

o The optional drift angle pointer may be displayed only when the LNAV is selected as the primary NAV source and valid information

is present. If the pointer information becomes invalid it will be removed from the display.

o An additional configuration option was added with software 09 allowing a full time display of the drift angle pointer. This allows the drift angle pointer to be displayed when the selected primary NAV source is not an LNAV and is intended to be used with the "Drift Angle Track" feature added to the weather radar interface by EFS software 09. See the section on Radar operation for a detailed description.

LNAV MODE ANNUNCIATIONS

o A configuration option selectable at the time of installation and certification allows the LNAV mode annunciators to be displayed above the three letter vertical source annunciator "FMS", "LOR", or "GPS". The following annunciators will be displayed in the priority listed:

- MSG white flashing for five seconds and then solid
- DR white flashing for five seconds and then solid
- WRN white flashing for five seconds and then solid (deleted in software 07 and higher)
- WPT white flashing for five seconds and then solid
- HDG white
- XTK white
- APR white

360 MAP DISPLAYS

Refer to Figures. 4.1.7 and 4.1.8 while reviewing 360 MAP DISPLAYS.

The EFS 40/50 provides two basic map formats, a 360-degree map display about the aircraft and an approximately 85-degree sectored map display in front of the aircraft. Information which may be displayed includes waypoints, navaids, airports and weather radar information. The type and amount of data presented on the map will depend on the interfacing equipment. When coupled with a compatible LNAV, such as the BENDIX/KING KNS 660, GNS XLs or KLN 90B, the EHSI can show up to 15 map symbols. These will include all flight plan waypoints that are within the selected display range.

In addition, the pilot can choose to display either navaids or airports that are located off the flight-planned route. Up to 10 navaids or up to 4 airports can be displayed as long as the total number of map symbols does not exceed 15.

In software version SW 06, up to 10 airports may be displayed.

In addition to the above, the #1 and #2 bearing pointers can be overlaid to indicate the direction and distance to two additional navaids or waypoints.

Waypoints referenced to the selected VOR may be displayed

when coupled with a simple RNAV, such as the BENDIX/KING KNS 81. The simplest map data is provided by plotting map symbols referenced to the aircraft using bearing and distance from the select bearing sensor.

Beginning with software 10, special waypoints without symbols are accepted by the EFS which may be used to display flight plan legs without the waypoint symbols at the connecting points. These waypoints are supplied by some LNAV's for search pattern flight plans.

Note: *The following will address only those areas of the EFS 40/50 map mode which are different from the standard compass presentations. All map presentations provide a traditional CDI display.*

MAP 360 COMPASS CARD

The operation of the compass card remains the same in the Map mode as in the standard EHSI display. However, the outside of the compass card now performs a secondary function by becoming the outer range ring for the Map display.

SELECTED COURSE

The alphanumeric course select readout in the upper left corner of the display functions the same in the map mode as in the standard EHSI mode. The standard EHSI selected course pointer, to/from

pointer, deviation bar and deviation scale are removed from within the compass card display. When the primary NAV sensor provides distance and bearing information the selected course pointer is replaced with the course line. If the primary NAV sensor "TO" or "FROM" waypoint or VOR is within the selected map range, a movable course line is drawn through its center. As the selected course is changed, the course line will rotate about the referenced point. If the selected primary NAV sensor is an approach on-side sensor, the inbound "TO" course line is green and the outbound "FROM" course line is white. If the selected primary NAV sensor is LNAV or enroute RNAV the inbound "TO" course line is cyan (green in approach mode). Any time the cross-side sensor is selected as the primary NAV sensor the inbound "TO" course line is yellow.

If the primary NAV sensor distance or bearing information becomes invalid the NAV symbol and course line will be removed. "NO MAP" will be displayed to alert the pilot that insufficient data is present to calculate and plot the primary NAV sensor map. "NO MAP" will also be displayed if the selected primary NAV sensor, (e.g. ILS, ADF), does not provide distance and bearing information. The lateral deviation scale will remain as long as valid bearing or deviation information is present.

MAP COURSE DEVIATION INDICATOR

A stationary white scale along the bottom center of the display provides reference for the course deviation bar to indicate the position of the aircraft in relation to the selected navigation course. This course scale provides a conventional CDI (course deviation indicator) presentation.

When LOC is selected while in a map mode, Back Course annunciation and CDI needle reversal is provided when the selected course is 105 degrees from the aircraft heading (results in a fly to situation). "BC", in green, (yellow "BC" if cross-side sensor is selected) is annunciated left of center on the lateral deviation .

TO/FROM

To the right of the alphanumeric Course Select a white "TO" or "FR" will replace the standard EHSI TO/FROM pointer when in non-ILS map modes.

BEARING POINTER

While in the map modes standard EHSI bearing pointers are displayed when the selected bearing source does not have distance associated with it or when the distance is greater than the selected map distance. Once the bearing source falls within display distance the bearing pointer is removed and the associated map symbol is displayed.

The #1 system map symbol will

be displayed in light blue and the #2 will be displayed in magenta as are the standard bearing pointers. If bearing or distance information becomes invalid, the map symbol will be removed. If only the distance information becomes invalid, the map symbol will be removed and replaced with the standard bearing pointer.

Note: See *BEARING POINTER*, under *STANDARD EHSI DISPLAYS* in this section for details on the display of Magnetic bearing pointers when the compass card is True referenced and the display of True bearing pointers when the compass card is magnetic referenced.

REFERENCE WAYPOINT

When the joystick is interfaced to an EFS 40/50 system, it can be used to generate and move a single Reference Waypoint on the display unit. This reference waypoint can then be entered into the KNS 81, KNS 660, KLN 88, or any other LNAV using an appropriate GAMA 429 interface. The KNS 81 must have the graphic output bus.

With an LNAV, RNAV, (or KNS 81 configured as a NAV) selected for the primary nav sensor and during display of a NAV MAP on the EHSI, initial movement of the joystick will create a reference waypoint ahead of the aircraft on the half range ring at the current heading. This will be true for both HSI and ARC map dis-

play formats. The reference waypoint will be a standard white waypoint symbol. Movement of the waypoint will be in any of the eight directions commanded by the joystick. The rate of movement will start off slow and increase in speed in two steps. Return of the joystick to its center, off position at any time will reset the rate of movement to the slowest speed. The reference waypoint location on the display screen and its rate of movement relative to the display screen will be independent of the display range selected. The reference waypoint is not allowed to exit the compass. When an LNAV is selected as the primary navigation source, Lat/Lon coordinates of the reference waypoint will be displayed in the lower center of the display. When a KNS 81 is the active primary navigation source, and it is not in the ILS mode, radial and distance of the reference waypoint from the navaid in use by the KNS 81 will be displayed instead of Lat/Lon coordinates. The reference waypoint position information can be transferred to the LNAV or KNS 81 that is selected as the primary navigation sensor, by pressing the ENTER button while the reference waypoint and its coordinates are displayed. The coordinates of the reference waypoint will remain displayed for at least 10 seconds and disappear from the display within 15 seconds after activating the ENTER button. If the reference waypoint is not moved for 20 seconds, it will disappear from view and will re-

appear in the same location relative to the display screen (independent of range selection) the next time the joystick is activated. However, a change of primary NAV sensor or display modes will reset the invisible reference waypoint location to its initial starting position.

Note: *Systems with an MFD can have a joystick on the CP 469A MFD control panel or a stand alone joystick. Additional joysticks for the pilot or co-pilot normally will not be installed. Systems without an MFD may have up to two joysticks that are completely independent of each other; one for the pilot and one for the co-pilot. The pilot's joystick will not be allowed to create or move a waypoint on the co-pilot's EHSI, and any waypoint created by the pilot can be loaded only into the #1 RNAV or #1 LNAV. Conversely, the co-pilot's joystick will not be allowed to create or move a waypoint on the pilot's EHSI, and any waypoint created by the co-pilot can be loaded only into the #2 RNAV or #2 LNAV.*

RANGE RING

A light blue range ring located half way between the center of the symbolic aircraft and the outside of the map compass scale aids in determining distance of radar returns and/or position of nav aids in relation to the aircraft. Off the right wing of the symbolic aircraft, adjacent to the range

ring is the range ring distance. The range ring represents half the distance to the outer range ring of the compass scale. The available ranges, selectable from the EFS 40/50 are 5, 10, 20, 40, 80, 160, 240, 320 and 1000 nm.

Note: *Systems which have the RDR 1400 interfaced with the EFS 40/50 will display weather ranges of .5, 1 and 2 NM. However, the NAV MAP feature is not supported on these shorter ranges.*

360-DEGREE MAP WX RADAR (IF EQUIPPED)

Refer to Figure 4.1.7 while reviewing this section.

If a compatible ARINC 708 weather radar such as the BENDIX/KING RDR 2000 or RDS series is installed, weather information may be selected for display. When selected, weather information will transparently overlay the existing navigation data. Light blue dotted lines represent the weather radar scan limits.

Depending on the installation, the EFS 40/50 may act as a weather radar range controller or as a simple remote display when the EHSI has weather selected and matches the radar range. As a display only, if weather is selected for display and the EHSI map range does not match the selected weather radar range “WX FLT” will be annunciated in the weather radar fault/warning position. As a range controller, if the

selected range does not match one allowed by the radar, “WX FLT” will be annunciated in the weather radar fault/warning position. When the 1000 NM range is selected “RANGE” is displayed and the weather radar is placed in standby. If the EFS 40/50 is the only display media for the weather radar, the radar will be placed in standby when weather is not selected for display.

Note: *EHSI installations with the BENDIX/KING RDR 2000 or RDS series radar provide dual range selection by allowing the radar indicator and EHSI or dual EHSIs to select independent ranges. Only one source of radar mode, tilt and gain is supported. When the ranges selected on the two controlling indicators do not match, the weather presentation will be updated on alternating sweeps of the radar antenna. Example: if pilot's EHSI is updated on the right sweep then the radar indicator will be updated on the left sweep or vice versa. In installations capable of providing weather information on three displays, the display without radar range control must match one of the controlling displays in order to present weather. If the range does not match, “WX FLT” will be annunciated in the weather radar fault/warning position.*

Four data lines are reserved below the primary NAV sensor source annunciator to display radar information. The first line

displays special performance feature annunciations such as ARL (automatic range limiting). The second line annunciates the standard radar modes WX, WXA or MAP. The third line provides a digital readout of tilt angle displayed in tenths of a degree preceded by an arrow pointing up or down to indicate tilt direction. If Auto Tilt is activated, an "A" will follow the tilt arrow. The fourth line will display radar faults and warnings. The radar faults are prioritized. When more than one fault or warning occurs the one with the highest priority will be displayed.

Target Alert is a feature provided by the RDR 2000 weather radar that is fully supported by EFS with software version 10. A white "TGT" annunciation in the weather radar failure/warning field indicates that the target alert feature of the RDR 2000 is enabled. When a target is actually detected that satisfies the conditions for a target alert, the white "TGT" changes to a yellow "TGTALRT" and an arc shaped symbol is displayed at the top center of the weather display. Consult the RDR 2000 pilot's guide for more detail.

Note: *Wx gain must be max and the ART must be scanning horizontally before the Target Alert feature is enabled. Target Alert is not enabled in the VP mode.*

EFS with 09 software interfaced to the RDR 2000 will display "TGTALRT" in white and the tar-

get alert symbol during an active target alert, however "TGT" will not be displayed to indicate the enabled condition.

A yellow dashed line, originating at the symbolic aircraft and extending to the edge of the compass card, appears on the weather display when either the track left or track right button is pressed on the radar control panel. The track line will be automatically removed within 15 seconds after the button is released.

RDR 1400 WEATHER RADAR

A complete interface to the RDR 1400 Weather Radar became available with the release of EFS software version 09. This interface requires an indicator to be used as the source of all radar control data except for range which is selected on the EFS control panel. All RDR 1400 ranges are supported including 2.0, 1.0, and 0.5 nm. All weather and search primary modes, the beacon secondary mode, and RDR 1400 faults are annunciated in the radar information fields below the primary NAV sensor annunciation on the EHSI or MFD. The primary and secondary modes are annunciated as shown in the following table:

RDR 1400 MODES	EFS 40/50 ANNUNCIATION
STANDBY	STBY
TEST	TEST
NORMAL WEATHER	WX
WEATHER ALERT	WXTG
SEARCH 1	SR 1
SEARCH 2	SR 2
SEARCH 3	SR 3
BEACON	BCN

All standard beacons (Type A) are displayed as two white arcs separated by 3.6 to 13 nm (separation distance determined by beacon ID code). All DO 172 (Type B) beacons are displayed as two white framing arcs 1.2 nm apart with one to four additional beacon ID arcs between the two framing arcs. When a beacon is identified, its ID code preceded by an “A” or “B” to indicate beacon type is displayed in blue at the beacon location on the EFS weather display just beyond the closest white arc.

RDR 1400 beacon and search gains, and antenna tilt value are not annunciated on the EFS.

Note: *A limited interface to the RDR 1400 is provided with EFS software versions before 09. TEST, STBY, and WX are the only modes annunciated. Beacon and Search modes are not annunciated. Beacon symbols are displayed as white arcs at the proper location, but without an ID number.*

LIGHTNING DETECTION

Up to 63 grey colored lightning cell symbols can be displayed on the EHSI or MFD displays when provided by a compatible lightning sensor. Unlike weather radar information, lightning data may be presented in all 360 degrees of display area. Range selection for all lightning data displayed on EFS is controlled by the EFS control panel. The EFS will display the following symbols

depicting three different levels of lightning intensity:



LEVEL 1 LEVEL 2 LEVEL 3

Lightning information will only be displayed while weather is selected for display on the EFS. Some versions of Radar Control Panels (RCP) have a lightning select button (see section 2.3) which will alternately select and de-select lightning for display, however when selected, the lightning data will be in addition to the weather radar information if both are provided. The weather radar may be placed in standby if only lightning information is desired.

A single lightning data field is located immediately above the weather radar data fields. Three annunciations are possible in this field as shown in figure 4.1.8 at the end of this section. The annunciation “ON” preceded by the lightning symbol indicates that lightning information has been selected for display and the lightning sensor is operational. The annunciation “OFF” preceded by the lightning symbol indicates that lightning has been de-selected using the lightning select button on the RCP. This annunciation is only presented while a weather mode is selected on the EFS and will not be displayed in installations without a lightning select button on the RCP. A fault condition is indicat-

ed by the annunciation “FLT” preceded by the lightning symbol. Possible faults are invalid or missing 429 data from the lightning sensor. Therefore, selecting lightning for display with power removed from the lightning sensor will cause a FLT annunciation on the EFS.

FULL TIME LNAV MAP

o Incorporated in software 05, is an option selectable at the time of installation and certification. It allows the LNAV map to be displayed when the selected primary NAV sensor is either an ILS or ADF in the map mode.

Before software 05 or after software 05 without the full time LNAV map configuration selected, when the selected primary NAV sensor is either an ILS or ADF with the map mode selected, the “NO MAP” message will be annunciated since sufficient data is not provided to create a map presentation. However, if a bearing pointer sensor is selected which provides bearing and distance information, an appropriate map symbol will be displayed if the selected map range is greater than the distance to the navaid or waypoint. If the selected range is less, a normal bearing pointer will be displayed.

If the full time LNAV MAP option is selected, the LNAV map will be

presented when ever the selected primary NAV sensor is either an ILS or ADF with the map mode selected. The LNAV map will be presented all in white to show that the information being displayed is not to be used as primary navigation information. The purpose of the LNAV map information being presented is to provide the pilot better orientation between his present position and intended flight plan, mainly for use during the phase of the approach while being vectored for the intercept. Primary navigation must be accomplished according to the raw data presented by the selected primary NAV sensor being displayed on the lateral and vertical deviation pointers, not by the LNAV map

The LNAV map will be displayed only if an LNAV is installed on the same side as the selected ILS or ADF primary NAV sensor and the map mode is being displayed.

Note: *Extreme care must be taken when this mode is used not to focus on the LNAV map. Depending on the LNAV being used, the accuracy may be off several miles, providing opposite fly-to commands than the ILS or ADF. It is a must that the primary NAV sensor data be the data flown.*

Map not certified for primary navigation.

ARC (EXPANDED SECTORED MODE) DISPLAYS

Refer to Figure 4.1.9 while reviewing ARC DISPLAYS.

The expanded sectored (ARC) format provides an enlarged display of weather radar information and increased resolution of navigation data due to the enlarged compass scale presentations.

Note: *The following will address only those areas of the EFS 40/50 ARC mode which are different from the standard EHSI compass or MAP presentations.*

HDG BUG (ALL ARC FORMAT MODES)

Heading bug operation is the same in all modes. The only

noticeable difference in the ARC mode is that the digital orange readout of selected heading is displayed only when the heading bug is not completely in view. In this event the heading readout appears on the side of the compass scale closer to the heading bug's hidden position.

COURSE DEVIATION INDICATOR (EHSI ARC NON-MAP FORMAT)

The rotating white course deviation scale operates the same in all non-map modes. The differences in the ARC modes are location and size: the scale is moved to the bottom center of the display and is slightly reduced in size.

CUSTOM (NON STANDARD EHSI) DISPLAYS

The displays covered in this section are custom displays, created at the request of specific customers to satisfy unique requirements. Every attempt was made to ensure these displays followed standard EFS 40/50 colors, symbology and methodology. In some cases this was not possible, it is therefore, most important to read the following information and ensure you have a very good understanding of the display and its intended use. If there are any questions concerning the following displays, contact the installing agency or a Honeywell factory representative for additional information.

DOPPLER

Refer to Figure 4.1.10 while reviewing the DOPPLER DISPLAY.

o Incorporated in software 04, the Doppler mode, annunciated as DOPP, provides navigation information from a Doppler NAV sensor. Primary use of this mode is helicopter related, with the intended purpose of search and rescue hover. The DOPP mode is displayed on the EHSI as dual concentric velocity and target range circles inside the compass card. Cross bars represent components of the aircraft's left/right and fore/aft velocity.

Note: *The following will address only those areas of the EFS 40/50 Doppler mode which are*

different from the standard EHSI presentations.

w **COMPASS CARD**

The map compass card is used in the DOPP mode, the symbolic aircraft however, is the larger one used in the normal EHSI mode.

w **DOPPLER VELOCITY BARS**

Green bars, the length of the compass card's diameter, represent the aircraft's velocity left/right (Vx) and fore/aft (Vy) as referenced to the symbolic aircraft. The intersection of the two bars provide the sum of the two velocity components.

If the Doppler velocity information becomes invalid or failed the velocity bars will be removed and a RED X will be displayed in the center of the compass.

w **VELOCITY AND TARGET SCALE**

Two white concentric circles inside the compass card provide reference for the Doppler velocity bars and LNAV target waypoint. When used as a reference for the Doppler velocity these circles represent 10 and 20 KTS with the compass card representing 30 KTS of velocity. When used as a reference for the target waypoint they represent .2 NM and .4 NM with the compass card representing .6 NM.

The symbolic aircraft is one sixth the size of the compass card; making it 5 KTS or .1 NM to wing tips or tail and nose.

w **LNAV GROUND SPEED AND READOUT**

A cyan display of ground speed information from the LNAV is provided in the upper right corner.

If the ground speed information becomes invalid or failed, a cyan FMS with a RED X drawn through it will be displayed in the distance location.

w **WIND VECTOR INFORMATION**

If an appropriate LNAV is installed and is providing valid information, wind information will be displayed in its normal location. See WIND VECTOR under STANDARD EHSI DISPLAYS for additional information.

w **TARGET WAYPOINT**

A cyan waypoint symbol will be displayed representing target position if an appropriate LNAV is installed and is providing valid information.

w **TENDENCY CIRCLE**

A green circle, the diameter of which corresponds to 5 kts, is displayed if an appropriate autopilot is installed and is providing valid command data. If the autopilot indicates winchman control, the circle will be dashed.

If the autopilot fails, "COUPLER" in RED with a RED X through it will be annunciated in the upper left corner and the tendency circle will be decluttered.

o An option selectable at the time of installation and certification provides an interface for systems that do not have an autopilot input. This configuration option may also be selected if the RED "COUPLER" warning flag is not desired when interfaced with an autopilot.

w **MEMORY**

If the Doppler NAV sensor goes into the memory mode and advises the EHSI, "MEMORY" in orange will be displayed above the symbolic aircraft, and the velocity bars and circles will change to orange to alert the pilot.

w **HEADING BUG**

Software version 05 added the heading bug to the Doppler display and activated the Heading datum and analog deviation outputs for autopilot coupling.

CABLE

Refer to Figure 4.1.11 while reviewing the CABLE DISPLAY.

Incorporated in software 04, the cable mode, annunciated as CAB, provides navigation information from a cable position sensor. Primary use of this mode is helicopter related, with the intended purpose of search and rescue hover, and heavy lift operations. The CAB mode is displayed on the EHSI as dual concentric circles on the compass card. Cross bars represent cable angular position left/right and fore/aft relative to the aircraft..

Only one cable sensor system may be interfaced to the EFS 40/50 at a time. If more than one system is interfaced, it will have to be externally switched into the EHSI.

Note: *The following will address only those areas of the EFS 40/50 Cable mode which are different from the standard EHSI presentations.*

w **COMPASS CARD**

The map compass card is used in the CAB mode, the symbolic aircraft however, is the larger one used in the normal EHSI mode.

w **ANGLE BARS**

Green bars, the length of the larger circle's diameter, represent the cable's position angle

left/right component (Px) and fore/aft component (Py) as referenced to the symbolic aircraft. The intersection of the two bars provide the vector sum of the two position components, or actual angular position of the cable referenced to the aircraft.

If the cable sensor information becomes invalid or failed the position angle bars will be removed and a RED X will be displayed in the center of the compass.

w **FUNNEL SCALE**

Two concentric circles inside the compass card and compass card azimuth ring itself provide reference for the cable position angle bars. A white inner circle represents 6 degrees of cable deflection. A yellow circle represents 12 degrees. The compass card azimuth ring represents 18 degrees of cable displacement.

The symbolic aircraft is one sixth the size of the compass card; making it 3 degrees to wing tips, tail and nose.

w **WIND VECTOR INFORMATION**

If an appropriate LNAV is installed and is providing valid information, wind information will be displayed in its normal location. See WIND VECTOR under STANDARD EHSI DISPLAYS for additional information.

w **OPTIMUM CABLE POSITION CIRCLE**

A green circle, 1/12 the diameter of the compass card, is displayed if an appropriate autopilot is installed and is providing valid command data. If the autopilot indicates winchman control, the circle will be dashed.

If the autopilot fails, "COUPLER" in RED with a RED X through it will be annunciated in the upper left corner and the tendency circle will be decluttered.

o An option (YES - NO COUPLER), selectable at the time of installation and certification, provides an interface for systems that do not have an autopilot input. This configuration option also may be selected if the RED "COUPLER" warning flag is not desired when interfaced with an autopilot.

w **THRUST COMMAND**

If the cable position sensor provides the thrust command, the angle position bars and 12-degree funnel circle change to orange.

w **HEADING BUG**

Software version 05 added the heading bug to the Cable display and activated the heading datum and analog deviation outputs for autopilot coupling. Course datum output is not active in this mode.

HOMING

Refer to Figure 4.1.12 while reviewing the HOMING DISPLAY.

Incorporated in software 05, the Homing mode, annunciated as HOM, provides navigation information from a homing sensor. Primary use of this mode is to provide the pilot left-right navigation information to a beacon. The HOM mode is displayed in much the same way as the standard EHSI. Since the homing sensor provides only left-right guidance information, the alphanumeric selected course display is removed from the upper left corner as is the course pointer head and tail. The deviation scale and bar are displayed in a horizontal manner and do not rotate with the compass card. The display provided resembles a standard EHSI with a heading failure. However, the compass card will function normally.

Two homing sensors may be interfaced to the EFS 40/50 at a time.

Since the basic Homing display closely resembles the standard system, all normal display options are provided in the Homing mode. All 360 EHSI and ARC formats are operational as is the addition of bearing pointers.

Note: *The following will address only those areas of the EFS 40/50 Homing mode which are different from the standard EHSI presentations.*

w **LATERAL DEVIATION BAR**

A green bar, the length of a standard EHSI D-Bar, represents fly left, fly right commands as referenced to the symbolic aircraft.

If the Homing sensor information becomes invalid or failed the deviation bar and scale will be removed and a RED X will be displayed in the center of the compass.

SENSITIVITY SCALE AND POINTER

If the installed Homing sensor provides a sensitivity output, a stationary white vertical sensitivity scale will appear on the right or left side of the EHSI display as configured at the time of installation and certification. This scale

provides a reference for the sensitivity pointer, which moves in relation to the scale to indicate signal strength being received by the Homing sensor.

The sensitivity pointer will have "SN" displayed inside it to advise the pilot of the type of data he is monitoring.

When the on-side sensor is selected for display the sensitivity pointer is green in color. When the off-side sensor is selected for display the sensitivity pointer changes to yellow alerting the pilot he has select other than his on-side NAV sensor.

If invalid or failed sensitivity data is received, the sensitivity deviation pointer and scale are removed.

Note: *The scale and pointer used to display sensitivity information is the same as that used for Glideslope and Vertical Navigation.*

**This page intentionally left blank.*



Figure 4.1.3
TYPICAL EHI 40/50 DISPLAY



Figure 4.1.4
LOSS OF HEADING DISPLAY

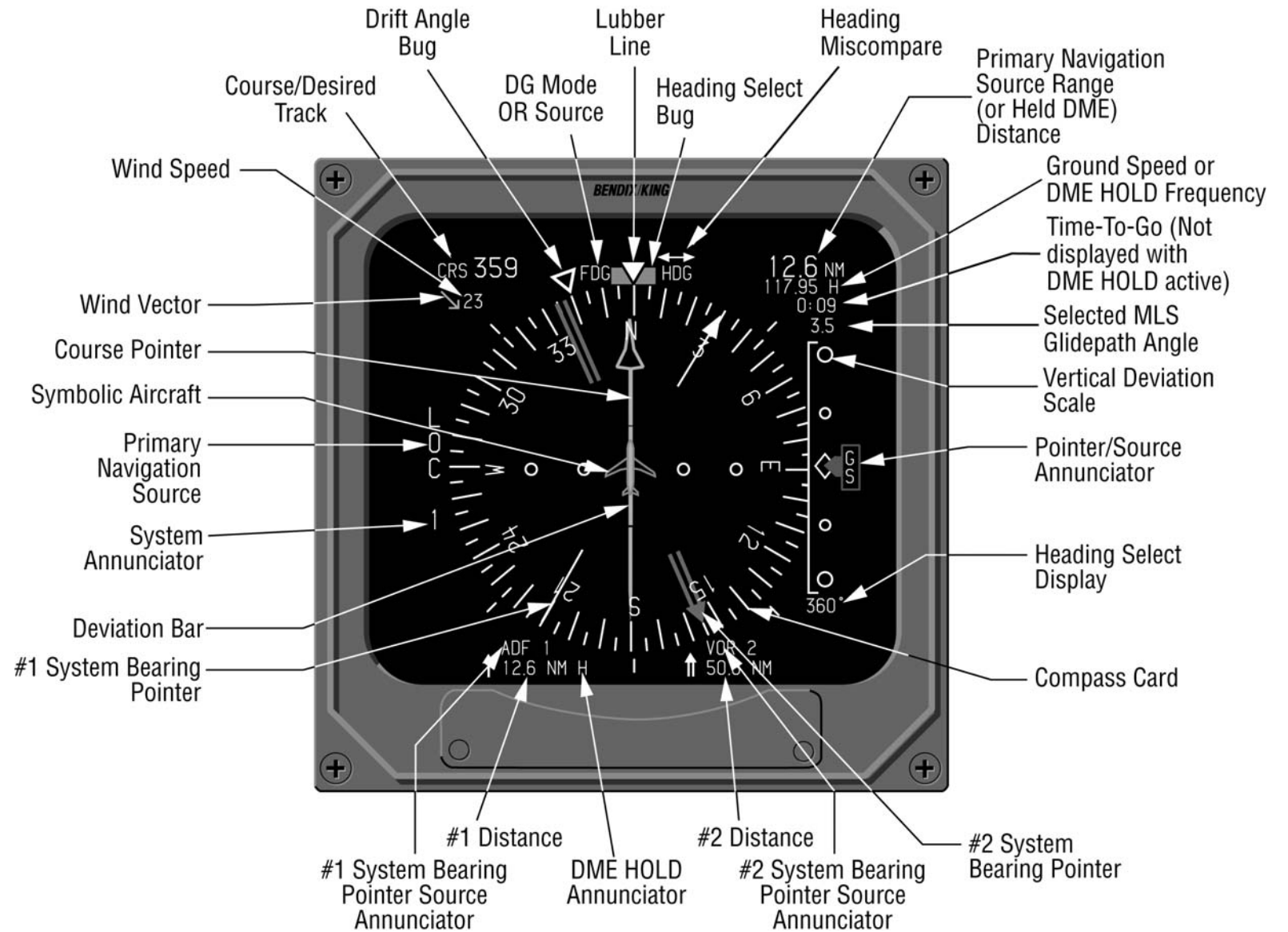

Figure 4.1.5
EHSI SYMBOL DEFINITION

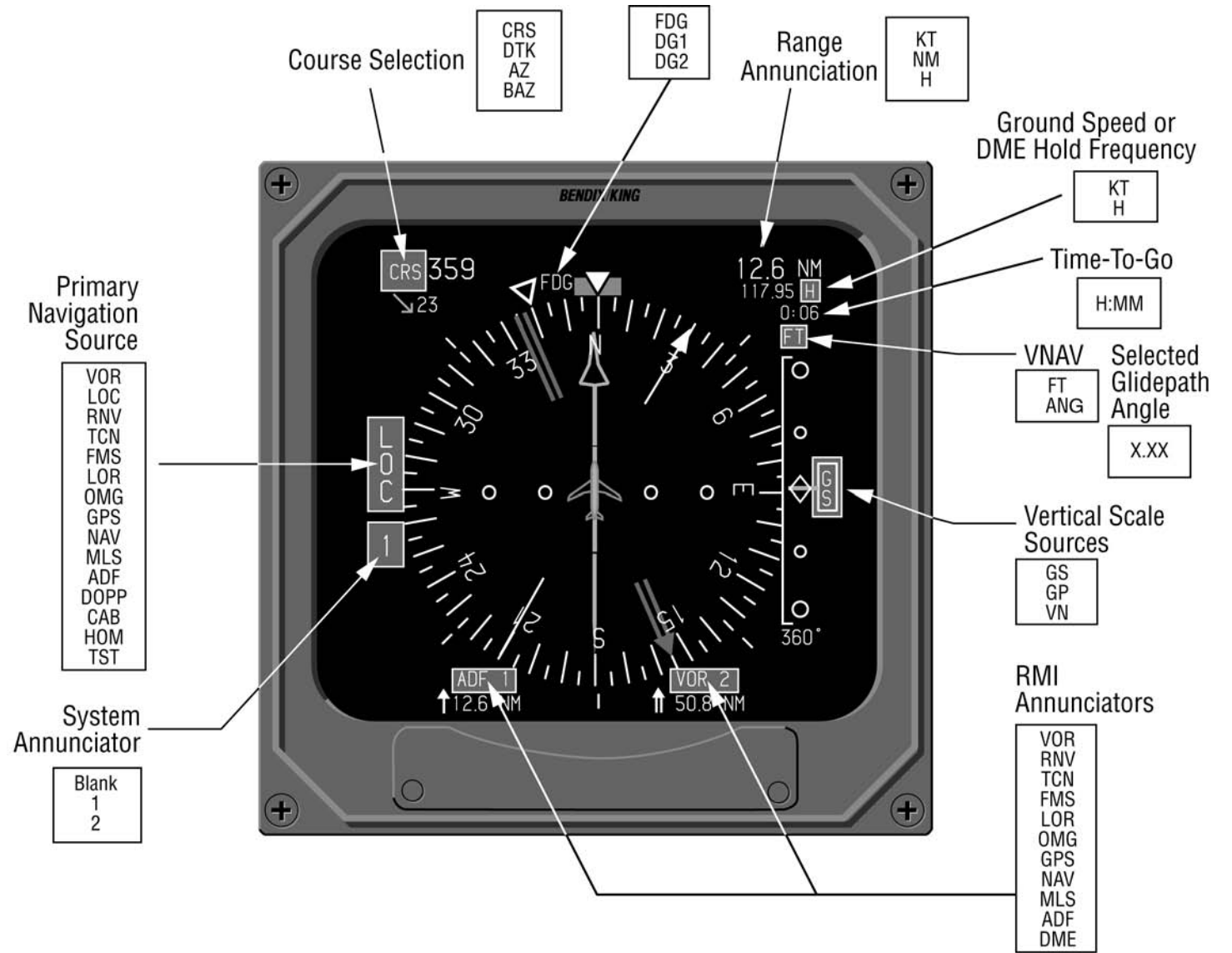

Figure 4.1.6
EHSI SYMBOL DEFINITION

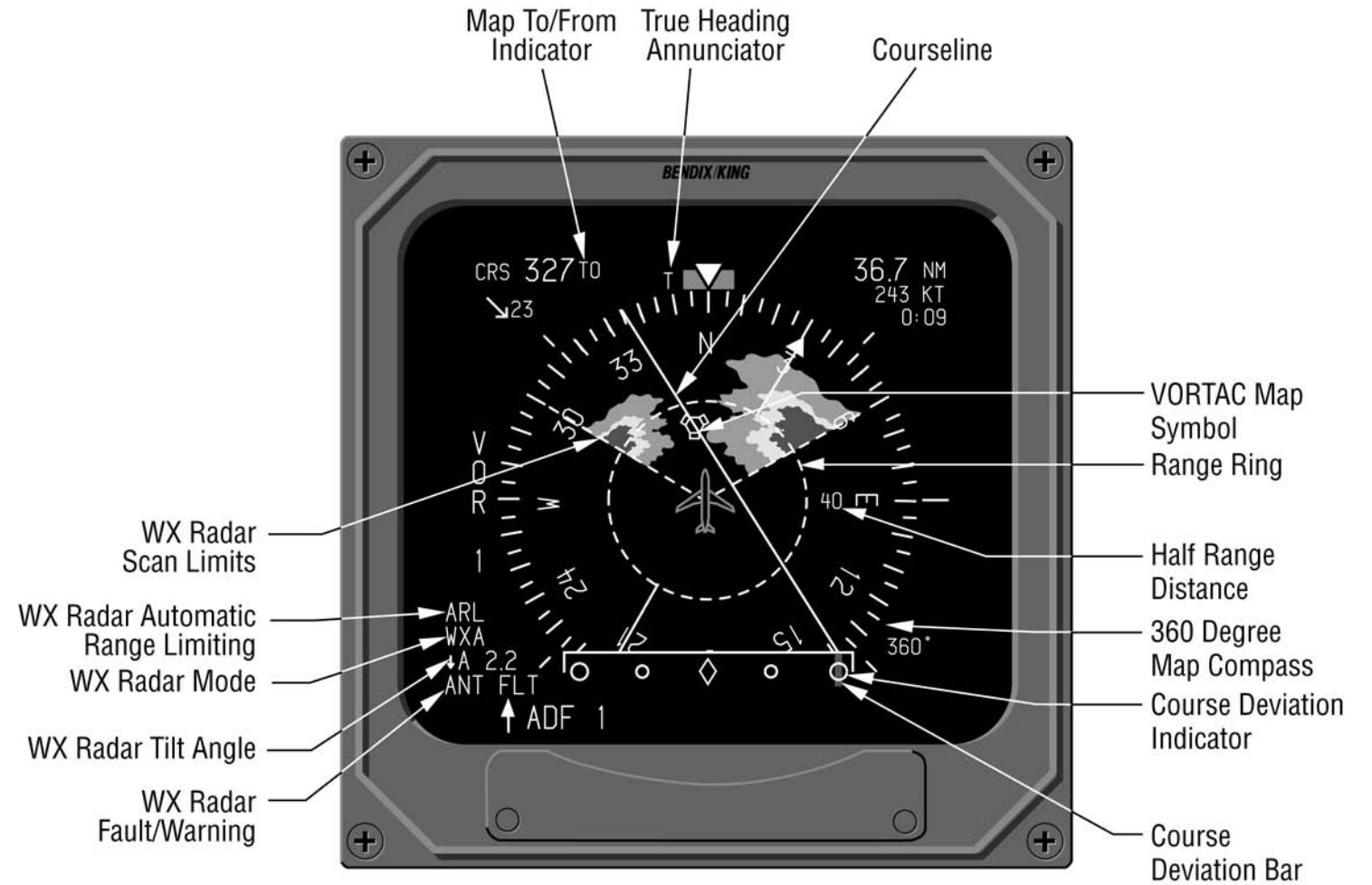
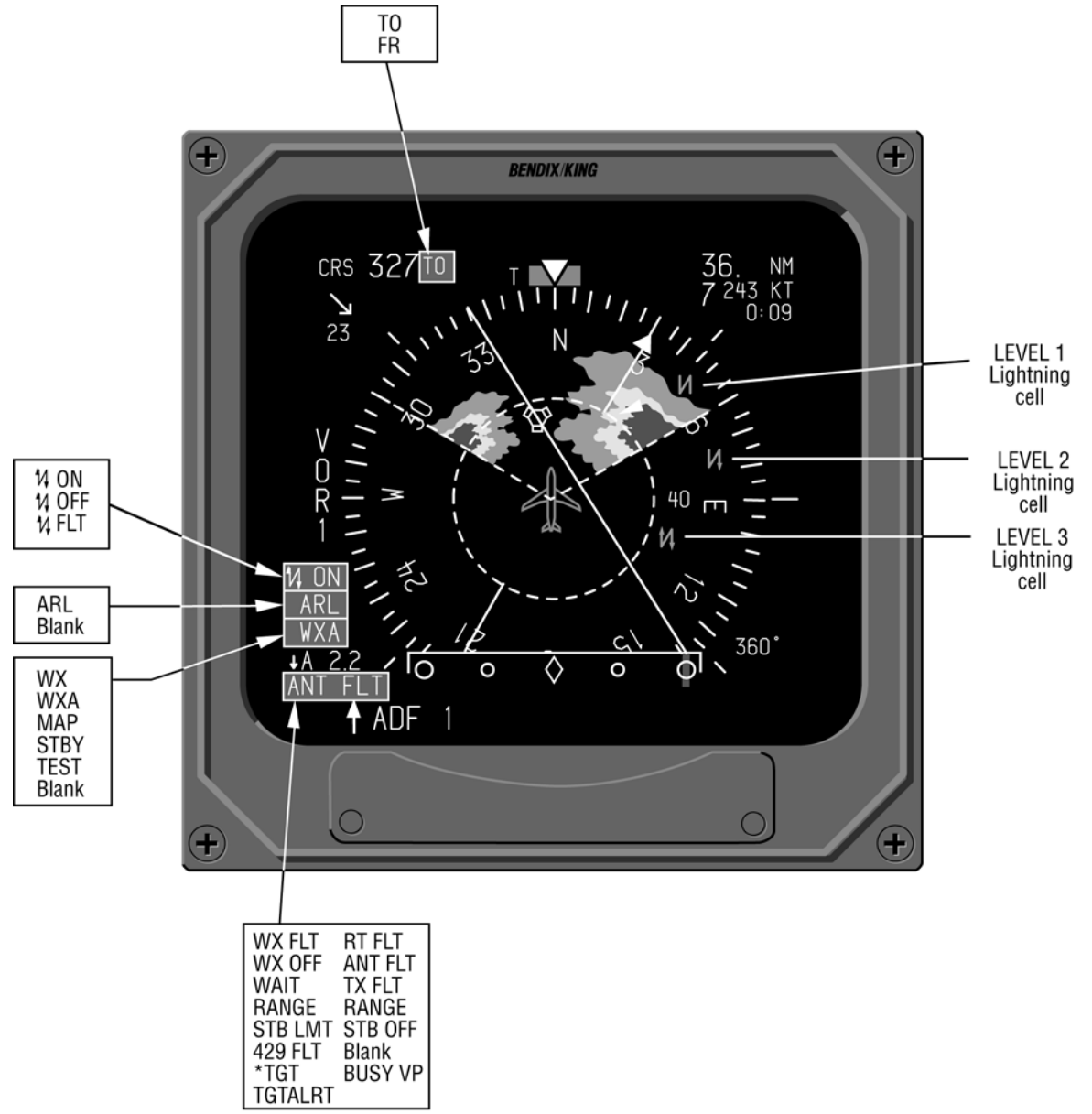

Figure 4.1.7
EHSI MAP SYMBOL DEFINITION



* Available only beginning with SW version 10

Figure 4.1.8
EHSI MAP SYMBOL DEFINITION

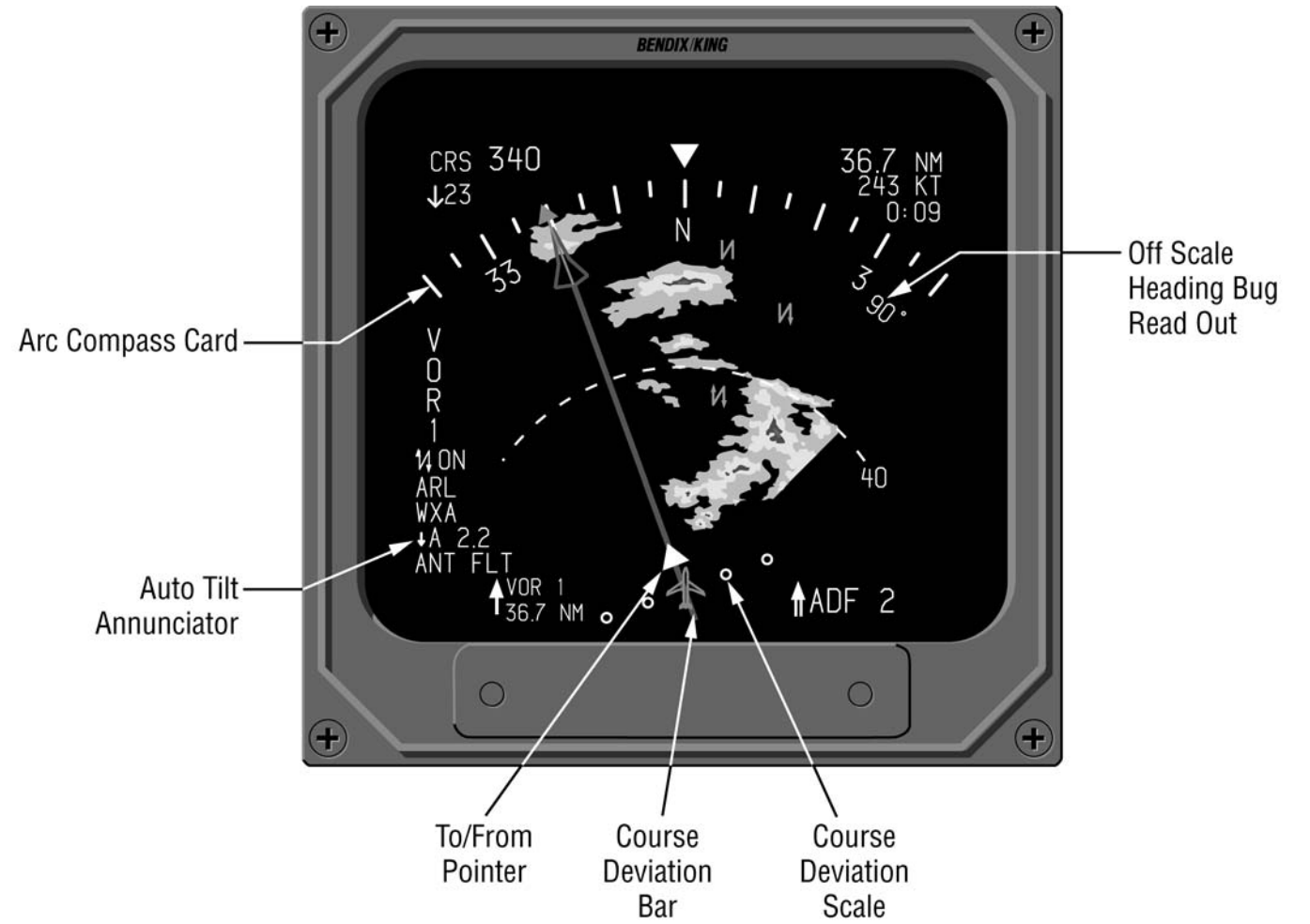

Figure 4.1.9
EHSI ARC MAP SYMBOL DEFINITION

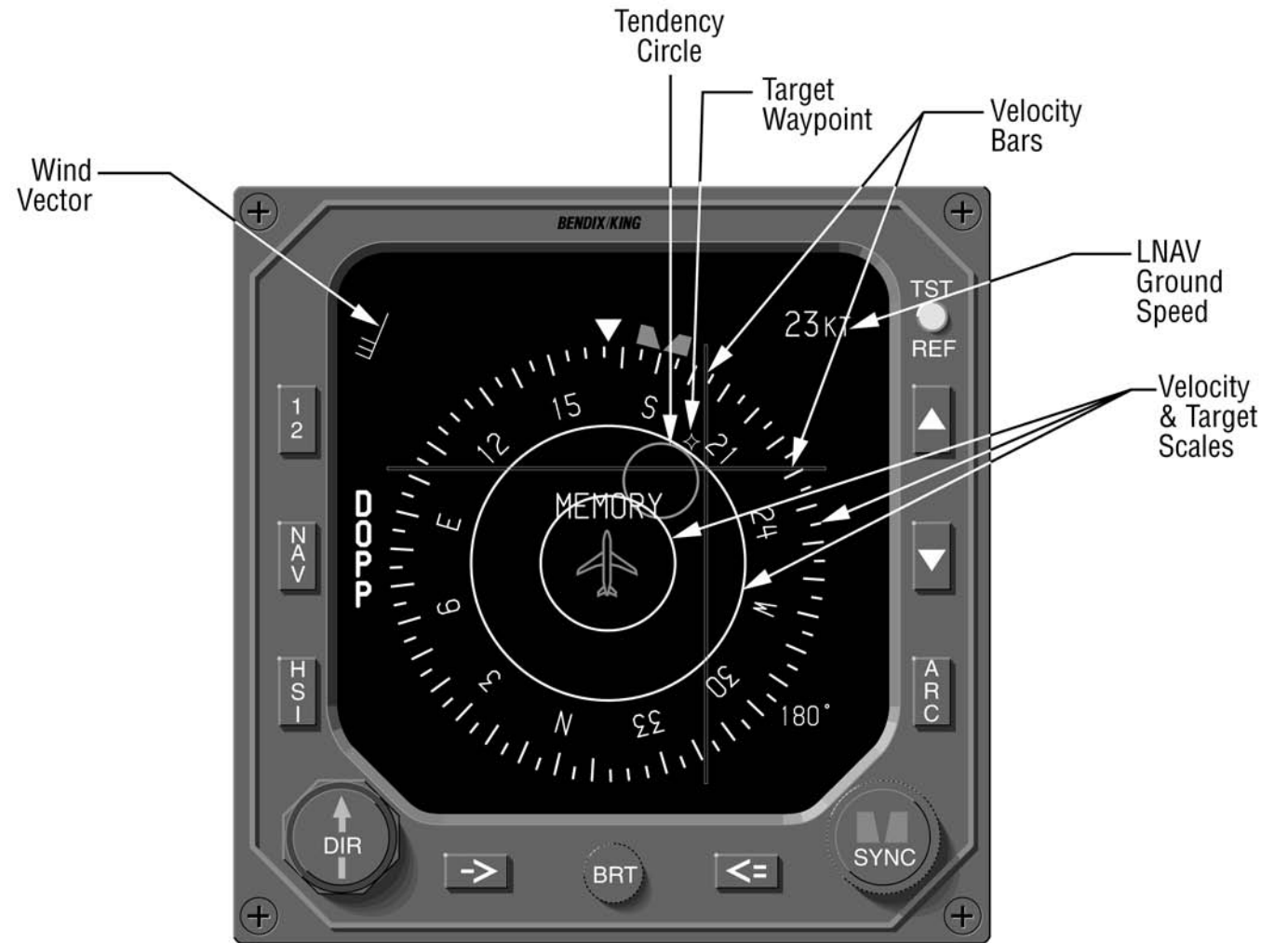

Figure 4.1.10
EHSI DOPPLER SYMBOL DEFINITION



Figure 4.1.11
EHSI CABLE SYMBOL DEFINITION



Figure 4.1.12
EHSI HOMING SYMBOL DEFINITION



Figure 4.1.13
EHSI FAULT ANNUNCIATION

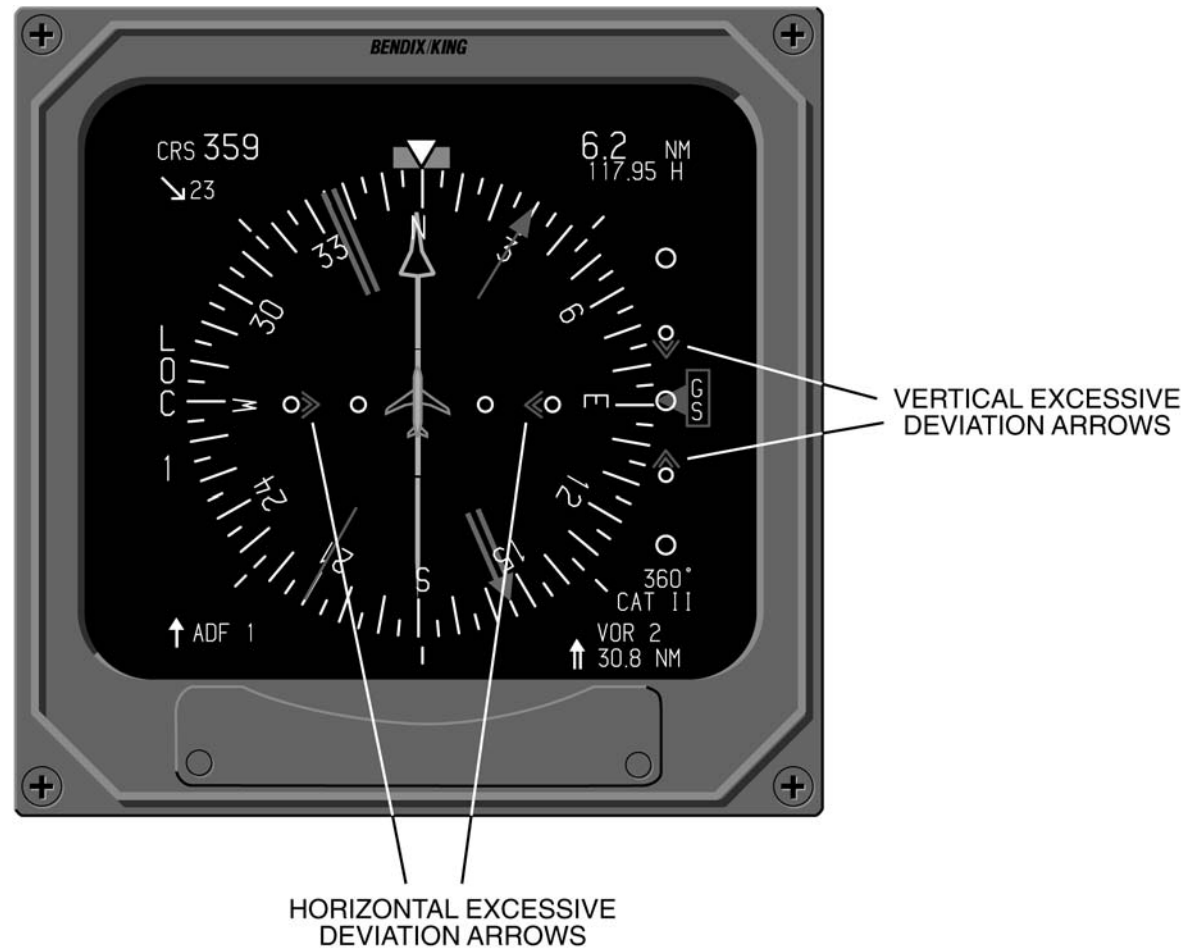

Figure 4.1.14
EHSI CAT II SYMBOLOGY

EADI DISPLAYS

NORMAL ATTITUDE DISPLAY

PITCH ATTITUDE

A moving white simulated horizon line rotates angularly with the roll of the aircraft and moves up and down with the pitch of the aircraft. Blue sky above the horizon and brown ground below the horizon align with the horizon line as it follows the aircraft's pitch and roll. Pitch scale reference marks extend above and below the horizon line indicating 5, 10, 15, 20, 25, 30, 35, 40, 45, 50, 55, 60, 65, 70, 75, 80 and 90 degrees. Refer to Figure 4.2.3.

o Beginning with software version 13, Pitch Offset Sync can be configured to allow the displayed horizon and pitch scale to be offset by up to 10° above or below the absolute source. Intended for use in rotary wing aircraft only, the offset (10° maximum) allows synchronization of the displayed horizon to the current aircraft pitch when synchronization is

requested. While synchronized, two white plus(+) signs will indicate the location of the absolute horizon. A momentary (push on - push off) action switch must be used to request pitch offset sync or return to absolute pitch with no offset.

Note: *Pitch offset sync is a feature intended for use on rotary wing aircraft only, it is not intended for use on fixed wing aircraft. If a power reset occurs (this includes ADI Down and/or Composite modes), the pitch offset sync will be turned off and the attitude display returned to normal.*

In the event of a pitch or roll attitude failure, the pitch scale, roll scale, roll index pointer, blue sky and brown ground are removed from the display. Centered just below the roll scale, a RED "ATTITUDE FAIL" enclosed in a RED box will be annunciated.

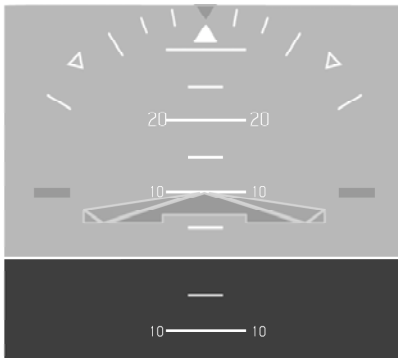

BEFORE SYNCHRONIZATION

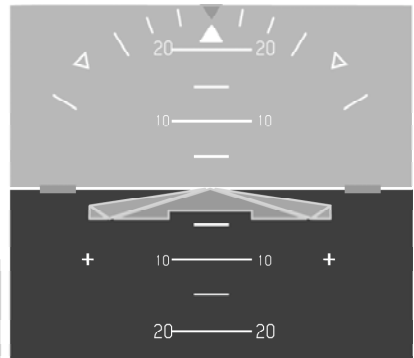

AFTER SYNCHRONIZATION

ROLL ATTITUDE

The EFS 40/50 provides two options for displaying roll attitude. The option selected for a particular installation is first determined by certification requirements of the aircraft, and secondly by pilot preference. The most common roll attitude display for four and five inch instruments is a fixed roll scale and movable index (sky pointer). The most common roll attitude display for three inch instruments is a moveable roll scale and fixed index (roll) pointer. The roll scale provides reference marks at 10, 20, 30, 45 and 60 degrees. To allow easier recognition of the 30, 60 and 45 degree marks, the 30 and 60 degree marks are longer extending further into the center of the display and the 45 degree mark is displayed in the form of a hollow triangle. Refer to Figure 4.2.4.

o An optional configuration item, selected at the time of installation and certification, allows the EFS 40/50 to declutter nonessential navigation data in the event an unusual attitude is encountered. Removal of the data will occur if pitch angle exceeds +30 or -20 degrees, or if bank angle exceeds 65 degrees. Red chevrons, used to indicate the best unusual attitude recovery direction (not necessarily right side up), will appear in the

brown ground raster between 40 and 85 degrees, and in the blue sky raster between 50 and 85 degrees.

In the event of a pitch or roll attitude failure, the pitch scale, blue sky, brown ground and roll index pointer are removed from the display. Centered just below the roll scale a RED "ATTITUDE FAIL" enclosed in a RED box will be annunciated.

ROLL INDICATOR

A filled white or yellow triangular pointer positioned just below the roll scale. If the Sky pointer option has been selected at the time of installation and certification, the roll indicator will be white and rotate with the pitch scale as the roll scale is fixed. If the Roll pointer option is selected at the time of installation and certification, the roll indicator will be yellow and fixed in the centered position as the roll scale rotates.

o Sky Pointer Roll Scale



Level Attitude



20° Right Roll

o Roll Indicator Scale



Level Attitude

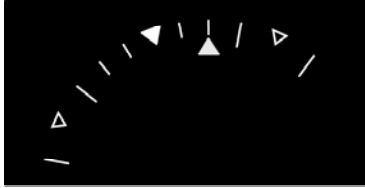

20° Right Roll

In the event of an attitude failure, the roll indicator is removed from the display.

PERSPECTIVE LINES

o A display option selected at the time of installation and certification. Orange lines extending 30 and 45 degrees downward from the center of the horizon line provide additional pilot cues in steep turns. Refer to Figure 4.2.4.

Note: The display of perspective lines with the delta (triangle) shaped aircraft symbol is considered unacceptable by some certification agencies.

SYMBOLIC AIRCRAFT

Located in the center of the display is the fixed orange aircraft symbol. The pitch and roll attitudes of the aircraft are displayed by the relationship of the fixed symbolic aircraft and the movable horizon. The symbolic aircraft is flown to satisfy the command cues of the flight director.

Note: The display of perspective lines with the delta (triangle) shaped aircraft symbol is considered unacceptable by some certification agencies.

The EFS 40/50 offers two symbolic aircraft symbols, the Bull's Eye and Delta. Selection of the single cue command bars will present a delta aircraft symbol, while selection on the double cue command bars will provide a traditional bull's eye aircraft symbol.



Aircraft Reference Delta



Aircraft Reference Bulls's Eye

HEADING TAPE

o An optional configuration item, selected at the time of installation and certification, allows a white heading tape with or without the selected heading bug to be displayed along the top of the horizon line. Index marks appear every 5 degrees with heading annunciation displayed every 30 degrees.

In the event heading data becomes unavailable or invalid, a stationary RED "HDG" enclosed in a RED box will be displayed above and to the right of the symbolic aircraft.

FLIGHT DIRECTOR

COMMAND BARS

Flight director commands are displayed as moving green or magenta bars when the flight director is engaged. Located in the center of the EADI display about the fixed aircraft symbol, indicating roll and pitch required to satisfy the computed flight director commands. Switching the flight director "OFF" or an invalid "FD" will cause the command bars to be removed.

Options selectable at the time of configuration allow the display of either:

- o Single cue command bars
- o Dual cue command bars
- o Pilot selectable between single or dual cue via an external switch.

The single cue command bars will present a delta aircraft symbol, while selection of the double cue will provide a traditional bull's eye aircraft symbol. Command bar color may also be configured as either green or magenta.

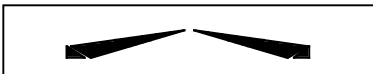

Single Cue Command Bars

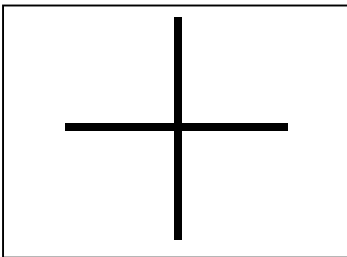

Dual Cue Command Bars

In the event of a flight director

failure, the command bars are removed and a stationary RED FD enclosed in a RED box is displayed just below the right 60 degree roll mark.

AUTOPILOT/FLIGHT DIRECTOR MODE ANNUNCIATION

w *STANDARD 429 AUTOPILOT/FLIGHT DIRECTOR MODE ANNUNCIATION*

o When interfaced with an appropriate 429 digital autopilot, such as the Bendix/King KFC 500, KFC 400, KFC 325 or KFC 225, an optional configuration item, selected at the time of installation and certification, allows the EFS 40/50 to annunciate a combination of autopilot and flight director modes. Engaged modes are annunciated in green along the top of the display and armed modes are annunciated in white just below the engaged modes. Only "GS", "GP", "VNAV" and "ALT" will be annunciated in white, in the Vertical Arm 2 field immediately below the engaged modes. Only "GS", "GP", and "ALT" will be displayed in the Vertical Arm 1 field immediately below the Vertical Arm 2 field. The engaged modes will flash for a minimum of 5 seconds when disengaged and beginning with software 0702, the engaged mode annunciation color will change to yellow while flashing.

The following tables and figure describe the annunciations and location in which they may be

displayed.

EFS SW	AP/FD MODE ANNUNCIATIONS					
	COUPLED STATUS		MISC MODES	BANK LIMIT	CWS	CMD DATA
	AP	YD				
04 and above	AP	YD	SR	HB	CWS	
05 and above						Altitude Airspeed MACH Vertical speed
06 and above			PTRM LTRM PTCH ROLL YAW			
09 and above	SAS or AP		RTRM YTRM	BL30 ---- BL01		
13 and above (KFC 500)	AP	SAS			DNT	

EFS SW	AP/FD COUPLE/ARM STATUS ANNUNCIATIONS					
	LATERAL			VERTICAL		
	ARM MODES	COUPLED MODES	ARM 2 MODES	ARM 1 MODES	PROFILE MODES	
04 and above	NAV APR LOC BC AZ BAZ	NAV APR LOC BC AZ BAZ HDG ROL	VNAV GS ALT IAS CLB MACH VS PIT GA ALTC DES	VNAV GS ALT	GS ALT	
05 and above					H N L	
14 and above (KFC 225)	BC (REV)	BC (REV)				
15 and above	GPS	GPS	GPS	GP	GP	

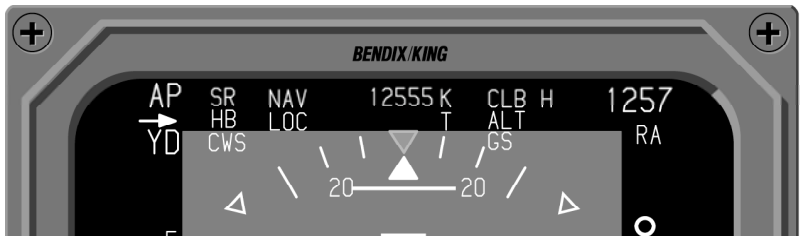

AP/FD MODE ANNUNCIATIONS

EADI Displays

Software release 06 added the following autopilot failure warning annunciations. They are listed in order of priority and will be displayed in the SR field:

- PTRM RED = pitch auto/manual trim fail
- LTRM RED = lateral autotrim fail
- PTCH RED = elevator servo failure
- ROLL RED = aileron servo failure
- YAW RED = rudder servo failure
- PITCH YELLOW = elevator mistrim
- ROLL YELLOW = aileron mistrim
- YAW YELLOW = rudder mistrim

Two additional failure annunciations were added by software release 09 to accommodate the KFC 500.

- RTRM RED = roll auto trim fail
- YTRM RED = yaw autotrim fail

The KFC 500 will use these two annunciations instead of "LTRM". If the flight director data becomes invalid, a RED "FD" enclosed in a RED box will be displayed at the right center of the display.

If the autopilot has been on and then disengaged, a RED "AP" will be annunciated in the upper left hand corner. Depending on the autopilot type, the RED "AP" may flash when disengaged.

In dual autopilot installations, the active side is annunciated by a green "AP" and the inactive side will be annunciated by a yellow "AP" with a yellow arrow pointing

toward the active side.

Beginning with software release 09, the KFC 500 autopilot coupled status "SAS" may be displayed in place of "AP". As with the "AP" annunciation, "SAS" will be either green or yellow to indicate active and inactive sides respectively and flashing red when disconnected. A steady red SAS annunciation indicates an autopilot power loss. See the KFC 500 pilots guide for more information.

Yaw damper, if engaged, may flash RED when disconnected depending on the autopilot type.

Beginning with software version 05, the following autopilot command reference data will be displayed in green when interfaced with the KFC 400/500:

- AIRSPEED
0 to 512KTS in 1KT increments.
- MACH
0 to 4.096M in 0.005M increments.
- VERTICAL SPEED
+/-20,480F/M in 100F/M increments.
- ALTITUDE
0 to 65536FT in 10FT increments.
- HIGH PROFILE
"H"
- NORMAL PROFILE
"N"
- LOW PROFILE
"L"

Note: Lateral/vertical modes and other annunciators are determined by the autopilot/flight director system installed.

Two additional features were added with 09 EFS software to accommodate the KFC 500 autopilot. Numerical bank limit annunciation and selected heading input from the flight control computer (FCC). The numerical bank limit is annunciated in green as "BLXX" where XX is the bank limit in degrees (1 to 30) provided by the FCC. This annunciation has priority over "HB" (half bank) which can be displayed in the

same field. Acceptance of selected heading from the FCC allows the pilot to use the Cyclic Beep Trim (CBT) switch to move the heading bug displayed on the EHSI compass card while the heading select mode is active.

Beginning with software version 14, the KFC 225 autopilot was added, and REV is annunciated instead of BC for the KFC 225 only.

w SFIM CDV AUTOPILOT/ FLIGHT DIRECTOR MODE ANNUNCIATION

o When the EFS 40/50 is configured to interface with the SFIM CDV 155 Autopilot/Flight Director, a unique set of armed and engaged lateral, vertical and collective mode annunciations will be displayed. Engaged modes are displayed in green across the

top of the EADI and armed modes are displayed in white on the second line from the top on the EADI.

The following annunciation modifiers are also provided by the SFIM CDV Autopilot/Flight Director:

- Green Autopilot Coupled Box around the mode annunciator
- Flashing Yellow Excessive Deviation Chevron

LATERAL	VERTICAL	COLLECTIVE
BC	ALT	ALT
CPOS	CPOS	CHT
GSPD	GA	CRHT
HDG	GS	GA
HOV	GSPD	GS
LOC	HOV	HHT
NAV	IAS	TDWN
TST	TDWN	TST
VORA	TST	TUP
AZ	TUP	VS
BAZ	VS	

SFIM CDV ENGAGED MODES

LATERAL	VERTICAL	COLLECTIVE
BC	CPOS	CHT
CPOS	GS	GS
LOC	TDWN	TDWN
NAV		
OSS		
VORA		

SFIM CDV ARMED MODES

- Yellow Degraded sensor color

RADIO ALTIMETER

o The radio altimeter display is composed of three elements; radio altimeter (RA) height, decision height (DH) set and decision height (DH) alert. In the upper right corner of the display, a field of white alphanumeric data provides radio altimeter height and annunciation. In the lower right corner of the display, a green alphanumeric field displays the selected DH. This field is active only when the DH set knob is active or when the radio altimeter is providing valid height data. To the right and above center of the display, a yellow “DH” alert is displayed in a black box outlined in yellow.

Depending on the type of radio altimeter installed, the elements of data displayed may vary. An altimeter which fully supports the interface will provide display of all three elements; RA, DH set and “DH” alert. Altimeters which do not fully support the interface may be limited to the “DH” alert annunciation. In such an installation, selected DH will not be displayed. DH set is accomplished outside the EFS 40/50 system on the radio altimeter. The EFS 40/50 receives an external command from the altimeter which activates the “DH” alert annunciation.

Radio altimeter (RA) height display range is -20 to 2,500 feet. Between -20 and 100 feet, height will be displayed in five foot increments. Above 100 feet, height will be displayed in 10 foot increments for EFS software before 09. Beginning with 09 software, RA altitude is displayed in 5 foot increments between -20 and 500 feet with 10 foot increments displayed above 500 feet. Selection of decision height and activation of “DH” alert will be in 1 foot increments. The maximum and minimum height displayed will depend on the radio altimeter installed. Some radio altimeters provide linear altitude information only to 1,000 feet. Refer to the operators handbook for the particular radio altimeter installed for details on the possible display range.

Note: *20 ft is the minimum altitude displayed when a KRA 10A is the configured radio altimeter.*

To annunciate an operational radio altimeter which has not acquired a valid ground response, three white dashes are placed in the height data field. If the radio altimeter has failed, three RED dashes are placed in the height data field. In either case, if the rising runway is displayed, it will remain fixed at the bottom of its scale and moves laterally to indicate the LOC or MLS deviation.

DECISION HEIGHT SET

o A part time green alphanumeric readout, located in the lower right corner, displays the letters DH and selected decision height in feet as manually established by the DH set control knob. With the control pulled out, the DH set value is displayed and may be set regardless of aircraft altitude. With the control knob "in", DH is displayed only for radio altimeter altitude less than 2500 feet AGL. The DH set display range is from "OFF" (-1 ft.) to the RA declutter value (2,500'). Refer to Figure 4.2.2.

DECISION HEIGHT ALERT

When the radio altimeter height is equal to or less than the selected decision height, the DH annunciator will be displayed. When first activated, the DH annunciator will flash for 10 seconds. The DH symbol is a large yellow "DH" on a black background enclosed by a yellow box, located to the right of the pitch scale and above the horizon line when in normal attitude. Refer to Figure 4.2.2.

PRECISION APPROACH MODE FORMAT

The precision approach mode display is obtained by selecting the ILS MLS or GPS navigation source. (i.e. using the NAV button) If an ED 462 or 551A is used as the EADI, the full

sky/ground display is reduced in size to provide a high contrast black background for various scales and annunciations. A rising runway symbol is provided for the display of expanded left/right deviation and runway closure during the final 200 feet of radio altimeter height. The rising runway center line, referenced to the lateral deviation scale, will provide LOC, MLS or GPS deviation. A "LOC", MLS, or "GPS" annunciation identifies the sensor in use. This annunciation is not provided after 07 software if only one sensor type is used. A vertical scale is provided to display an approach glidepath. Refer to Figure 4.2.2.

EXPANDED LATERAL DEVIATION SCALE

Located at the bottom center of the EADI, displayed in white, with 2 hollow circles on standard ADI display and 4 circles on a composite ADI display and a center diamond is the expanded lateral deviation scale. This scale provides a reference for the rising runway symbol with ILS, MLS or GPS selected. As an expanded scale, it represents 1/2 full scale deviation as displayed on the EHSI. When the selected course and aircraft heading differ by more than 105 degrees, the left/right sensitivity is reversed and a green (onside) or yellow (offside) BC is displayed left of the center diamond to alert the pilot that back course information is being displayed. Refer to Fig-

ure 4.2.3 and 4.2.4.

Software version 07 and higher will display the expanded localizer/MLS/GPS scale as three dots.

Note: *Warning, some conventional ADI expanded ILS and MLS displays represent 1/4 of the full scale displayed by the HSI. The EFS 40/50 provides 1/2 the EHSI displayed deviation to provide better pilot interface.*

RISING RUNWAY

Three configuration options are selectable at the time of installation and certification for display of the rising runway symbol.

o The first option provides full time display of the rising runway only when in the precision approach mode. The symbolic rising runway will be displayed in the lower center of the display just above the LOC/MLS/GPS approach expanded lateral deviation scale. The center line of the symbolic rising runway represents ILS, MLS or GPS approach fly to command. If the radio altimeter provides height above the ground information to the EFS 40/50, the rising runway symbol will start increasing in size at 200 feet and will continue to increase in size to 0 feet. When the on-side ILS, MLS or GPS approach is selected as the primary NAV sensor, the rising runway will be green in color. If the off-side sensor is selected, the runway will change to yellow,

alerting the pilot that he has selected off-side information.

o A second configuration option provides for the display of a traditional deviation bar in place of the rising runway. The deviation bar will overlay the lateral deviation scale. It will not be positioned just above the deviation scale as the rising runway is.

o A third configuration option allows the display of the rising runway unless one of the following conditions exists, in which case the deviation bar will be displayed.

- No radio altimeter
- Radio altimeter is not being displayed, above 2,500 feet or not providing computed data
- Radio altimeter is below minimum altitude, white dashes displayed
- Radio altimeter is flagged, RED dashes displayed.

In the event the lateral deviation information becomes invalid or failed, the rising runway or D bar and lateral deviation scale are removed, the lateral deviation scale is replaced with a RED "X."

Beginning with software 09, the deviation bar and scale are decluttered when lateral deviation information is provided in ARINC 429 format with a status of No Computed Data (NCD). The red "X" is still displayed for invalid or missing data.

GLIDESLOPE/VERTICAL NAVIGATION

When the selected primary NAV sensor is ILS, MLS or LNAV with VNAV selected, a stationary white vertical deviation scale will appear on the right or left side of the EADI display as configured at the time of installation and certification. This scale provides a reference for the vertical deviation pointer. The deviation pointer moves in relation to the scale to indicate glide path center with respect to aircraft position.

When the on-side sensor is selected for display, the deviation pointer is green in color. When the off-side sensor is selected for display, the deviation pointer changes to yellow alerting the pilot that he has selected his off-side nav sensor.

If the selected sensor is ILS or MLS, a "GS" (or "GP" for MLS with software 08 and higher. It can be either GP or GS after software 08. The configuration is selectable.) will be displayed in the pointer. "VN" will be annunciated if the selected sensor is an LNAV with VNAV selected. If the selected sensor is "GPS", a GP will be displayed in the vertical pointer during a GPS approach,(with SW15 or higher and configured for variable VNAV).

Additional configuration options selectable at the time of installation and certification:

- o Declutter GS on Back Course, allows the vertical deviation scale to be in view at all times or only when the selected course is within 105 degrees of the aircraft heading.
- o Vertical Scale Side, allows the vertical deviation scale to be displayed on either the right or left side of the EADI and EHSI display.
- Vertical Pointer Type, allows the vertical pointer to be displayed as one of three options:

o



o



o



- o Vertical pointer annunciation for MLS can be configured as "GP" beginning with software 08.

EADI OFF-SIDE ILS/MLS/GPS

- o A configuration option selectable at the time of installation and certification allows display of the off-side ILS/MLS/GPS data on the EADI while the EHSI is displaying on-side data. All deviation data and symbology are displayed as typically defined by the EFS 40/50 operational characteristics. On-side information displayed on the EHSI will be displayed in green and the off-side information displayed on the EADI will be displayed in yellow.

Back course annunciation on both the EADI and EHSI is a calculated reference to the course selected by the on-side EHSI.

The EADI and EHSI deviation flagging will be independent when this configuration option is selected. The EADI may show a flag while the EHSI is displaying active data. The flag is tied to the source of deviation data.

Note: *This mode is not selectable by the flight crew as an “as desired mode of operation”. EADI deviation information is always displayed in yellow.*

To enable this feature, the following conditions must be met:

- The configuration option must be selected
- EHSI must be on-side
- Both sensors used (i.e. ILS, MLS, or GPS) must be in approach model. ILS/MLS tuned to an active frequency or GPS with an active approach
- EADI Down or Composite mode may not be selected

MARKER BEACON ANNUNCIATION

In the lower left corner, marker beacon information is displayed inside a hexagon shaped box. The outer marker, “OM” is displayed in cyan. The middle marker, “MM” is displayed in orange. The inner marker, “IM” is displayed in white. All three markers may be displayed simultaneously. Flashing of the marker display is also possible

providing the marker receiver flashes its output.

FAST/SLOW OR COLLECTIVE DISPLAY

An optional display item, selectable at the time of installation and certification. If configured, will be displayed on the opposite side of the EADI from the Glideslope scale. The scale consists of two vertical white unfilled diamonds and one white unfilled circle.

Beginning with software 09, a two dot fast/slow scale may be configured with the “F” and “S” representing full scale and the diamonds representing half-scale.

If Fast/Slow is configured, the scale and pointer will be displayed when the airspeed is within 13 knots of the airspeed bug. The scale and pointer may be removed when the airspeed is either 13 knots greater or less than the airspeed bug. The scale provides ± 10 knots indication. If airspeed is the referenced data, AS will be annunciated in the pointer. If angle of attack is the referenced data, AN will be annunciated in the pointer.

If the scale is configured for Collective display, it will operate in the same manner as the Fast/Slow. “CO” will be annunciated within the pointer when the scale provides collective information. As the scale factor may vary from aircraft to aircraft, it is necessary to refer to the aircraft flight manual supplement for those details.

Configuration options selectable at the time of installation and certification:

- o Display of no Fast/Slow or Collective scale.
- o Display of a single dot Fast/Slow scale.
- o Display of a single dot Collective scale.
- o Display of a two dot Fast/Slow scale, beginning with software version 09.

The pointer is green unless the collective option is selected, then it may be either green or magenta to match the color configured for the flight director command bars. Three pointer styles are also provided to match the configured GS pointer style.

If invalid or failed sensor data is received the deviation pointer and scale are removed and a RED X annunciated.

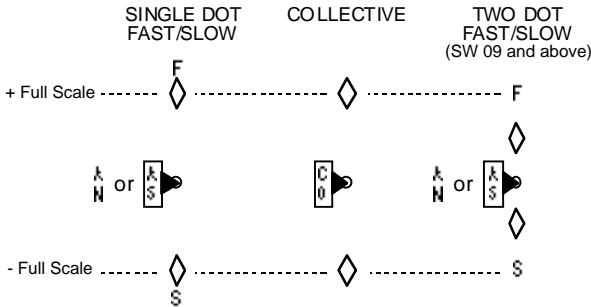

FAST/SLOW AND COLLECTIVE DISPLAYS

MACH DISPLAY

o MACH value may be displayed on the EADI beginning with software version 10. The MACH value is displayed in the lower left corner of the EADI as a white three digit number followed by the letter M. For example: 1.23M Configuring the EFS to display MACH value will prevent the display of a fast/slow or collective scale. Invalid, missing, or No Computed Data (NCD) for the MACH value will cause a flag condition (red dashes).

RATE OF TURN DISPLAY

o An optional display item, selectable at the time of installation and certification, if configured, will be displayed at the bottom center of the EADI. The rate of turn scale is composed of three evenly spaced unfilled white rectangles. The rate of turn pointer is an equally sized white filled rectangle balanced atop a smaller white filled rectangle.

The rate of turn indicator will not be displayed when the composite reversionary mode is selected for display.

If rate of turn data becomes invalid, the pointer and scale will be removed and replaced with a RED "X".

o Software release 0702 incorporated configuration items for bank angle correction of the yaw rate gyro. This correction takes into account the aircraft roll attitude when displaying rate of turn information.

CATEGORY II ANNUNCIATOR

Refer to Figure 4.2.7 while reviewing this section.

o An optional annunciator provides advisory only information, selectable at the time of installation and certification. When configured, the symbol generator will monitor the appropriate on-side and cross-side information and alert the crew when Category II requirements or limits are not satisfied.

The Category II Annunciator is functional in either single or dual EFIS installations and provides different limits for FAR and JAR-AWO certifications. The functionality and requirements are slightly different between the two systems, however, the intended function is the same.

o Software release 0702 expanded the configuration options for Category II display. The additional options allow the operator to select at installation time whether to display the CAT

II annunciation as well as the excessive deviation limits or the CAT II annunciation only. These additional options provide the flexibility of display where the operator Category II limits deviate from the set limit set in the EFS 40/50 configuration selections.

w *CATEGORY II OPERATION ANNUNCIATIONS*

Activation of the remote momentary (Open/Ground after software 07/02) Category II switch by the pilot will cause a yellow CAT II to be displayed on the ADI and HSI to indicate that Category II annunciations are active. Category II can be activated at any time and in all normal modes of the EFS.

In the normal sequence of events, a white CAT II will be displayed on the ADI and HSI in place of the previous yellow CAT II only when certain criteria are met:

w *DUAL EFS SYSTEM*

The following requirements must be met in a four or five tube EFS system before the Category II annunciator will change to white:

1. Valid ILS or MLS #1 is selected on Symbol Generator #1.
2. Valid ILS #2 is selected on Symbol Generator #2.
3. Valid ATT #1 is selected on Symbol Generator #1.

4. Valid ATT #2 is selected on Symbol Generator #2.
5. Valid HDG #1 is selected on Symbol Generator #1.
6. Valid HDG #2 is selected on Symbol Generator #2.
7. Pilot and copilot symbol generator are valid.
8. Both crosstalk buses are valid.
9. Copy, composite or ADI-down modes are not active.
10. Radio altitude is valid and between 2,500 feet and 50 feet.
11. True heading is not active.
12. Valid pilot flight director.
13. Pilot's command bars in view.
14. No attitude, heading, localizer, glideslope or radio altitude miscompare flags.
15. Front course ILS or MLS approach.
16. Pilot's flight director (if available) engaged in localizer and glideslope.

Additional requirements to be added to the above criteria if applicable:

- Both pilot and copilot ILS #1 and #2 frequencies must match if known and valid.
- Both pilot and copilot MLS #1 and #2 channels must match if known and valid.
- Valid copilot flight director if configured.
- Copilot's flight director engaged in localizer and glideslope if FD configured.
- Copilot's command bars in view if FD configured.

w **SINGLE EFS SYSTEM**

The following requirements must be met in a single HSI and ADI EFS system before the Category II annunciator will change to white:

1. Valid ILS or MLS #1 is selected
2. Valid ATT #1 is selected.
3. Valid HDG #1 is selected
4. The symbol generator is valid.
5. Neither composite nor ADI down mode is active.
6. Radio altitude is valid and between 2,500 feet and 50 feet.
7. True heading is not active.
8. Valid flight director.
9. Flight director engaged in localizer and glideslope.
10. Command bars in view.
11. Front course ILS or MLS approach.

A green CAT II will be displayed in place of the white CAT II on the ADI and HSI when the above criteria are met and the radio altimeter is between 500 and 100 feet. Beginning with 0702 software, excessive deviation monitoring became a configuration option and if configured, must also be within limits before the "CAT II" annunciation color changes to green. Green excessive deviation arrows (>> <<) will appear on the ADI and HSI localizer and glideslope scales. If the rising runway is configured for display, green chevrons will be displayed within it. Location of the excessive deviation arrows

EADI Displays

on the localizer and glideslope scales will be displayed according to the Category II limits.

Yellow flashing arrows on the localizer scales and yellow flashing chevrons on the rising runway will be displayed if the localizer pointer exceeds the limits set by the arrows (>> <<).

Yellow flashing arrows on the glideslope scales and yellow flashing GS in the glideslope pointer will be displayed if the

glideslope pointer exceeds the limits set by the arrows (>> <<).

All yellow excessive deviation symbols will flash.

White CAT II will be displayed below 100 ft., and no excessive deviation symbology will be displayed.

Yellow CAT II will be displayed below 50 ft., and no excessive deviation symbology will be displayed.

w **CATEGORY II THRESHOLDS**

The following Category II deviation limits can be configured for the comparison of excessive deviation and for the placement of the devia-

CONDITIONS				DEVIATION LIMITS (ft)		
EFS SOFTWARE	DEVIATION	RADIO ALTITUDE	APPROACH TYPE	FAR	JAR old	JAR new
06 0701						
	Localizer	500 to 300 ft	AP/FD	35		25
	Localizer	300 to 100 ft	AP/FD	25		25
	Glideslope	500 to 100 ft	AP	35		75
	Glideslope	500 to 100 ft	FD	75		75
0702 08 AND ABOVE						
	Localizer	500 to 300 ft	AP/FD	35	20	25
	Localizer	300 to 100 ft	AP/FD	25	20	25
	Glideslope	500 to 100 ft	AP/FD	75	65	75

CATEGORY II DEVIATION LIMITS

tion scale arrows.

Note: The FAR deviation limits are intended for guidance only since the FAR does not specify operational deviation limits for a CAT II display. FAR localizer limits will change on initial 300 feet crossing and will remain at new limits. JAR-AWO old limits, as well as no excessive deviation limits were added as configuration options by software 0702.

When activated, Category II limit (>> <<) indicators are displayed on the glideslope and localizer scale, chevrons will also be displayed on

the rising runway if it is configured for display.

ATTITUDE MONITOR

Dual channel processing of Attitude inputs provides validation of the processed displayed attitude information within the symbol generator. If a failure is detected in the processed information, "ATTITUDE FAIL" is annunciated at the top center of the display and blue sky and brown ground information and associated attitude scales are removed.

Note: There is no monitor function in any reversionary mode.

CROSS COMPARATOR ANNUNCIATORS

Refer to Figure 4.2.5 while reviewing this section.

Provides system comparison between like on-side and off-side sensors. The following list describes the associated symbology and sensors:

w RA

Radio altitude miscompare, a yellow RA above a double-ended arrow displayed just below the radio altitude readout in the upper right corner. This is displayed when SG 1 and SG 2 radio altitude differ by more than 8 feet at between 0 and 99 feet AGL. The Allowable difference increases by 8 ft per 100 ft of altitude. If the off-side RA flag is different the miscompare will also

be displayed.

w LOC

Localizer miscompare, a double-ended arrow will be displayed over the localizer deviation pointer on the EADI and EHSI when both SG 1 and SG 2 are tuned to an ILS/MLS frequency and differ by more than halfscale deviation.

w GS

Glideslope miscompare, a double-ended arrow will be displayed above the glideslope deviation pointer on the EADI and EHSI when both SG 1 and SG 2 are tuned to an ILS/MLS frequency and differ by more than halfscale.

w ATT

Attitude miscompare, a yellow double-ended arrow over "ATT" will be displayed in the top left corner of the EADI if ADI pitch 1, 2, and cross-side (if available) differ by more than 5 degrees or roll 1, 2, and cross-side (if available) differ by more than 6 degrees. The miscompare will also be displayed if the failure warning flags differ.

Note: In reversionary modes the EHSI Attitude may be used for

comparison if required.

w **HDG**

Heading miscompare, a yellow double-ended arrow over "HDG" will be displayed to the left of the lubber on the EHSI and right side center of the EADI if heading 1, 2, and cross-side (if available) differ by more than 6 degrees up to 6 degrees of bank and by more than 20 degrees above 6 degrees of bank. If bank information is not available, the miscompare will be displayed if heading differs by more than 20 degrees. The miscompare will also be displayed if the failure warning flags differ. Heading miscompare will be processed in the EHSI section of the symbol generator and displayed on the EADI if the heading tape is selected for display. Heading miscompare will not be performed if sources are not type matched (all magnetic or all true).

Note: *In reversionary modes the EHSI Attitude may be used for*

comparison if required.

Note: *Beginning with software 10, SG1 to SG2 comparisons of attitude, heading, and radio altitude are not performed if valid data is not available on the cross-talk bus between symbol generators. Therefore, failure of an SG in installations with both SG1 and SG2 configured can cause miscompare annunciations only with software versions before 10.*



Figure 4.2.1
TYPICAL EADI 40/50 DISPLAY

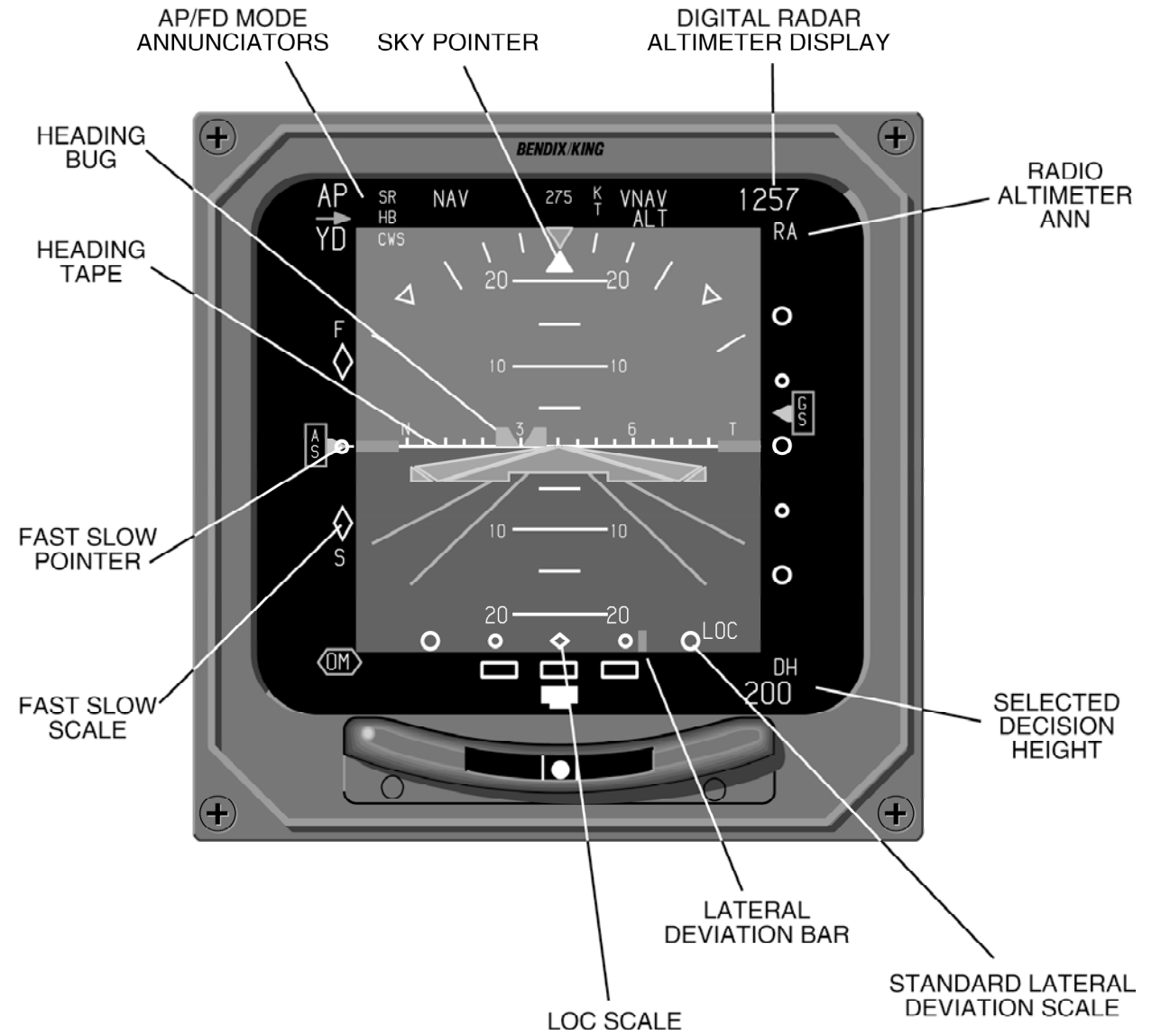

Figure 4.2.2
EADI SYMBOLOGY DEFINITION

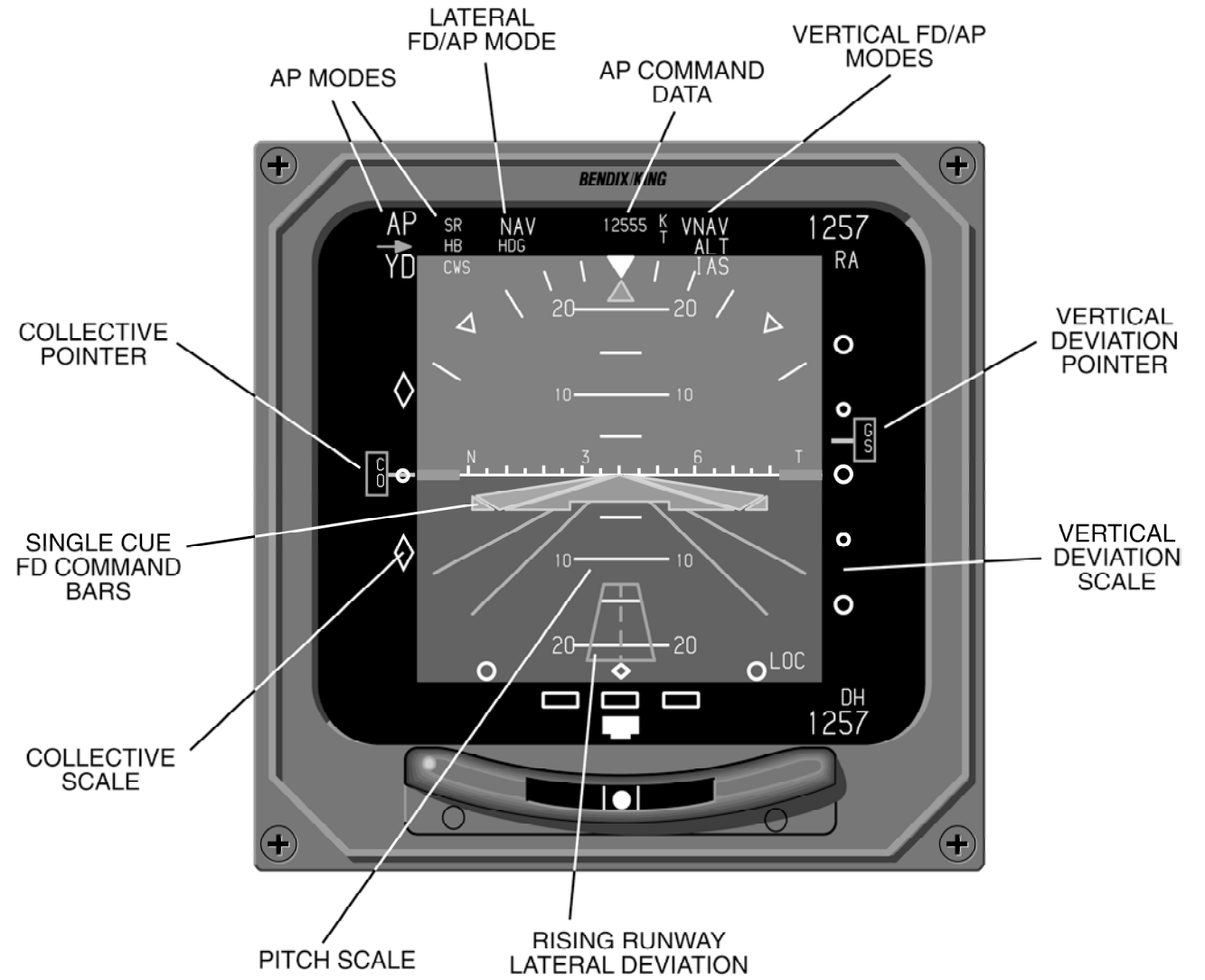

Figure 4.2.3
EADI SYMBOLOGY DEFINITION

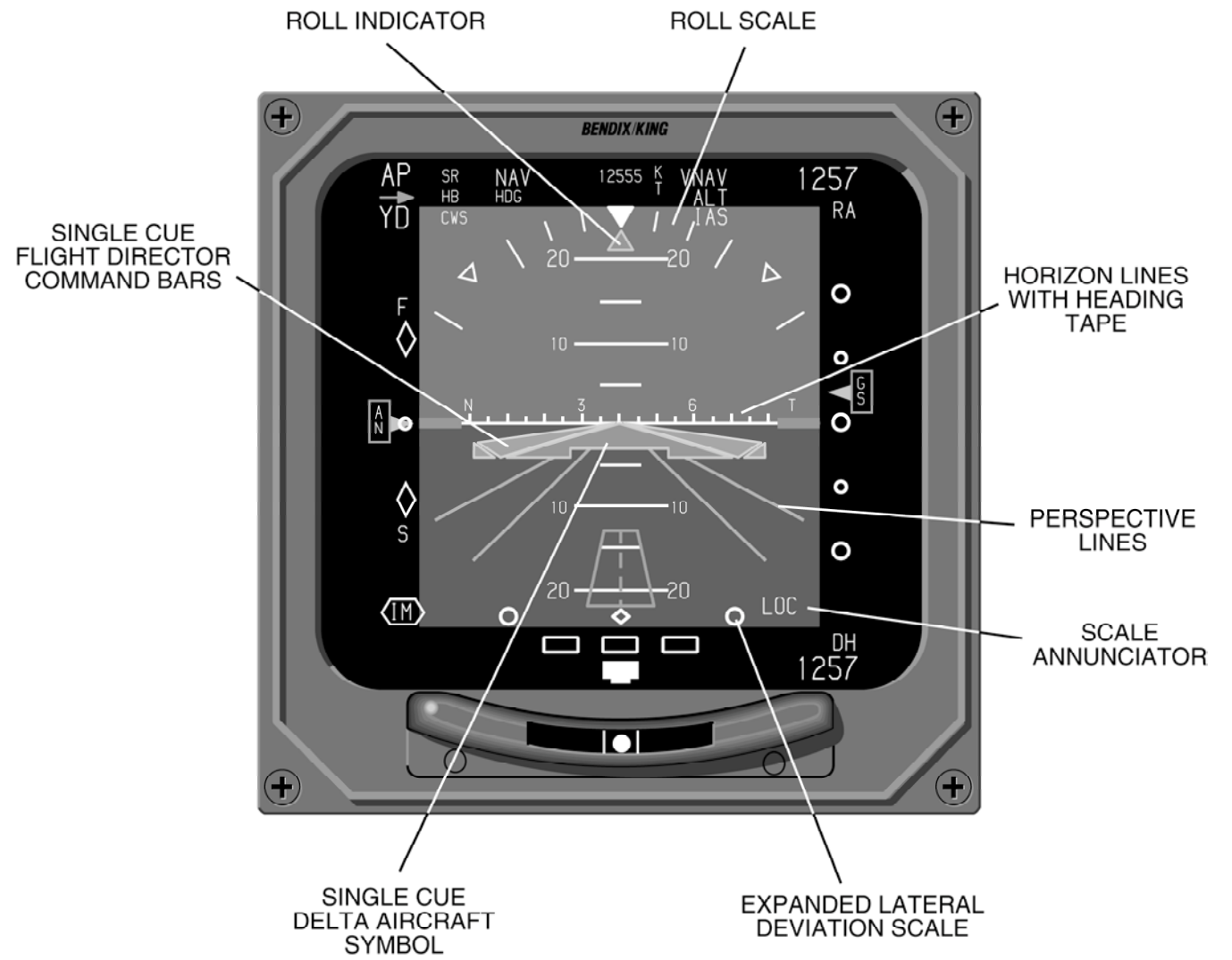

Figure 4.2.4
EADI SYMBOLOGY DEFINITION

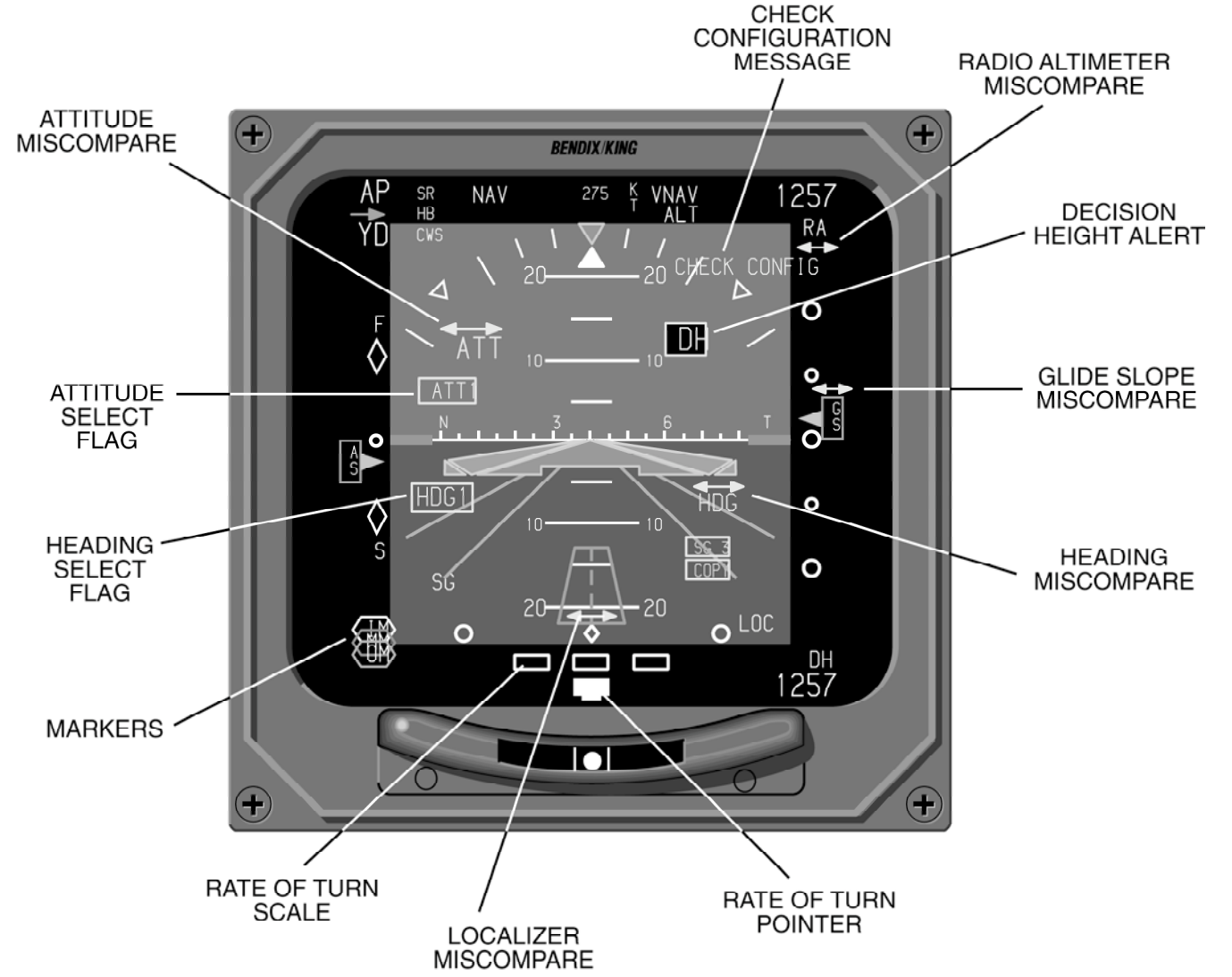

Figure 4.2.5
EADI SYMBOLOGY DEFINITION

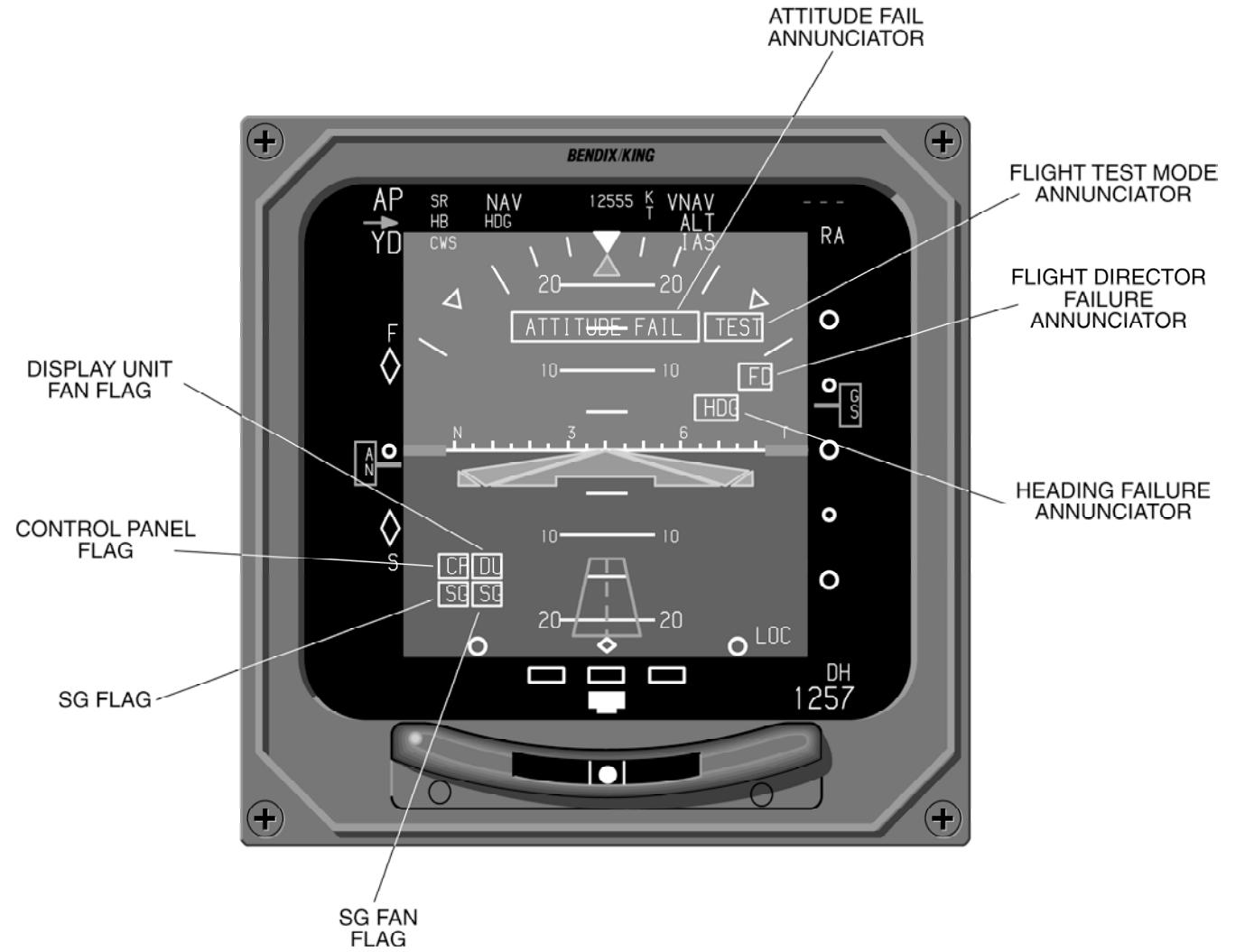

Figure 4.2.6
EADI FAULTS SYMBOLOGY

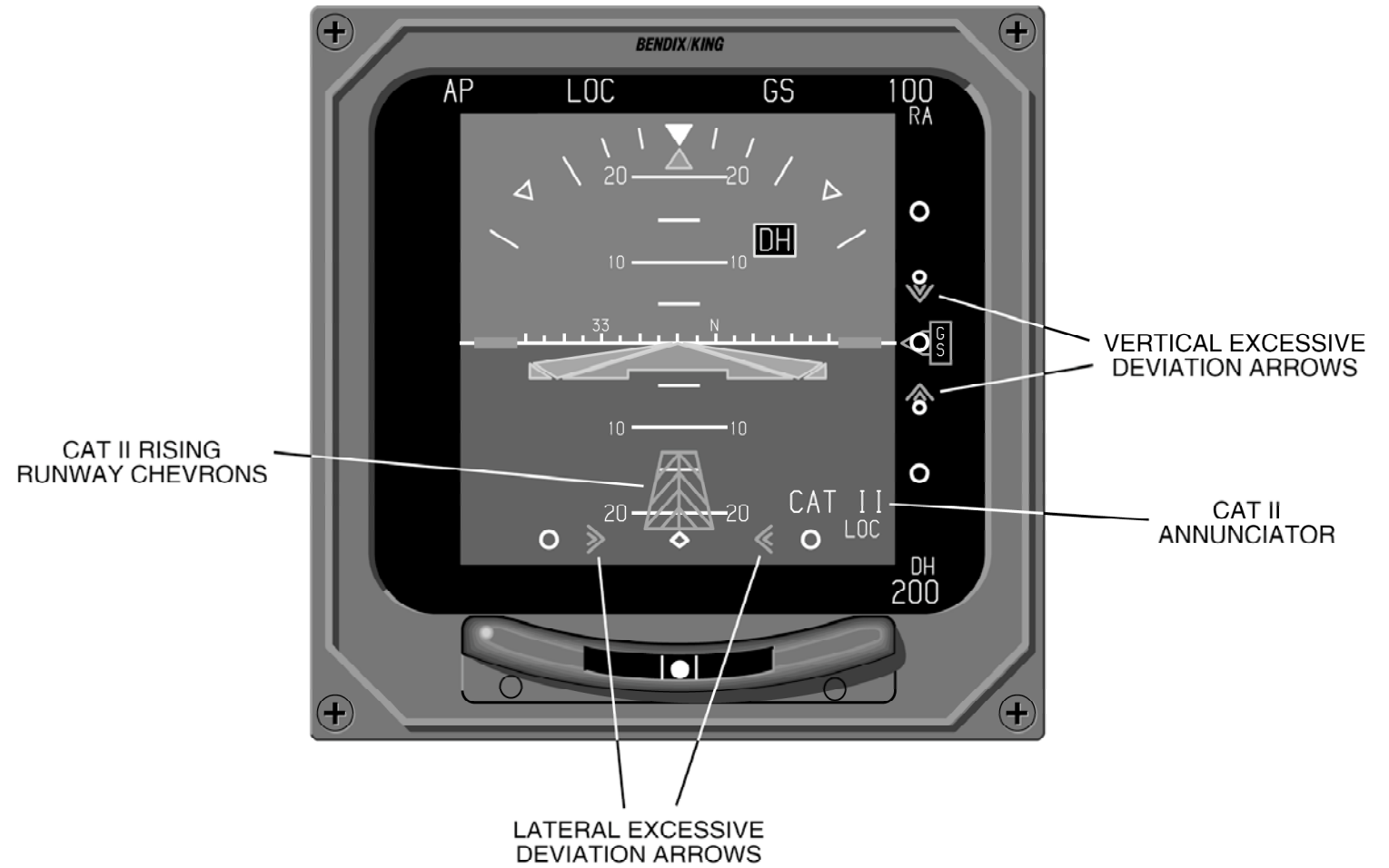

Figure 4.2.7
CAT II SYMBOLOGY



Figure 4.2.8
EXAMPLE EADI ENROUTE DISPLAY
WITH 08 SOFTWARE



Figure 4.2.9
EXAMPLE EADI APPROACH DISPLAY
WITH 08 SOFTWARE

COMPOSITE DISPLAYS

COMPOSITE MODE

Refer to Figures 4.3.1 and 4.3.2 while reviewing this section.

In the event of a display unit or EADI symbol generator section failure, the composite mode may be selected for display on the remaining good display unit by means of an external switch. The base composite display utilizes the standard EADI display for its foundation. To it is added a standard lateral deviation scale, selected CRS, selected HDG, distance information, DME HOLD annunciation, selected NAV sensor and TO/FR information. Creating a composite display in this manner provides the pilot a familiar display, which requires minimal transition time when it is selected for use.

Note: *The following will address only those areas of the composite display which differ from the standard EADI display.*

If the EADI section of the symbol generator fails, a full composite display may be displayed on the EHSI. If the EHSI section fails, only pitch and roll information will be displayed on the EADI.

HEADING TAPE

If not already configured for display, a white heading tape will be fixed along the top of the horizon line. Index marks appear every 5

degrees with heading annunciation displayed every 30 degrees.

In the event heading data becomes unavailable or invalid, a stationary red "HDG" will be displayed above and to the right of the symbolic aircraft.

SELECTED COURSE

Toward the bottom of the display, left of center is a green alphanumeric readout which provides a digital display of the selected course. In addition to the digital display, on the heading tape a downward pointing arrow provides a visual cue of the selected course with reference to the aircraft heading.

If the selected Primary NAV sensor is an on-side sensor the digital readout and pointer is displayed in green. If an on-side LNAV is the selected Primary NAV sensor and it is in the approach mode, the readout and pointer will be green. If the enroute mode is selected, the readout and pointer are cyan. If an off-side sensor is selected, the digital readout and pointer will be displayed in yellow.

HEADING BUG SELECT

Toward the bottom of the display, right of center is an orange (configuration options for cyan or magenta) alphanumeric readout which provides a digital display of

the selected heading. In addition to the digital display, on the heading tape is a hollow orange heading bug which provides a visual cue of the selected heading with reference to the aircraft heading.

Note: *As the aircraft heading changes, the selected course pointer and heading bug will follow the heading tape and may disappear from view. The heading bug and course pointer function the same as they do in the normal mode of operation, once set they are fixed to the heading tape or compass card.*

NAVIGATION SOURCE ANNUNCIATION

A vertical three- or four-letter alphanumeric readout located on the left or right side of the display, depending on vertical scale side selection, indicates the navigation selected as the primary navigation sensor.

Green annunciations indicate an on-side approach NAV system is being displayed. Yellow indicates the cross-side system has been selected. Cyan annunciations apply to on-side non-approach NAV systems. These color codes apply to the NAV source annunciator, CRS pointer, deviation bar, CRS, and distance.

If both sides select the same navigation source (i.e., pilot and

copilot select VOR 2) a yellow box is placed around the navigation source annunciator on both sides of the cockpit.

If both sides select their respective cross-side navigation source (i.e., pilot selects system 2, copilot selects system 1) then both NAV source annunciators will be yellow with no yellow box.

LATERAL COURSE DEVIATION SCALE

Located at the bottom center of the EADI, displayed in white, with four hollow circles and a center diamond is the lateral deviation scale. The course deviation scale provides a reference for the course deviation bar to indicate the centerline of the selected navigation or localizer or MLS course in relation to the center diamond.

The course width displayed in the composite mode is identical to that typically shown on the EHSI. Refer to the table on page 4.1.5.

LATERAL COURSE DEVIATION BAR

The course deviation bar represents the centerline of the selected navigation or localizer course.

If invalid or failed primary NAV sensor data is received the course deviation bar and scale are removed and a RED X annunciated.

Beginning with software 09, the deviation bar and scale are decluttered when lateral deviation information is provided in ARINC 429 format with a status of No Computed Data (NCD). The red "X" is still displayed for invalid or missing data.

TO/FROM

Displayed left of the center diamond on the lateral deviation scale, a white "TO" or "FR" will provide TO/FROM information when in non-ILS or non-MLS modes.

DISTANCE INFORMATION

An alphanumeric readout, located in the lower left corner, annunciates distance in nautical miles from the aircraft to the selected primary NAV station when in the VOR, TACAN, ILS or MLS mode, or to the waypoint in the LNAV or RNAV mode.

DME HOLD

When DME HOLD is selected, the DME distance and annunciator color will change to white and will remain white until the HOLD function is released. The sensor identifier (ADF, VOR, ILS, etc) shall retain the original assigned color. The HOLD function is additionally annunciated by an orange letter "H" displayed immediately to the right of the distance information. Ground speed and time-to-station are not displayed while DME HOLD is active.

Once the DME is placed in HOLD, its distance will continue to be displayed and will not be affected when the primary NAV sensor is changed.

DME HOLD will not function when MLS, LNAV or RNAV is the selected sensor. In this situation the associated distance field is always used to display waypoint or MLS distance.

**This page intentionally left blank.*



Figure 4.3.1
COMPOSITE ENROUTE MODE DISPLAY

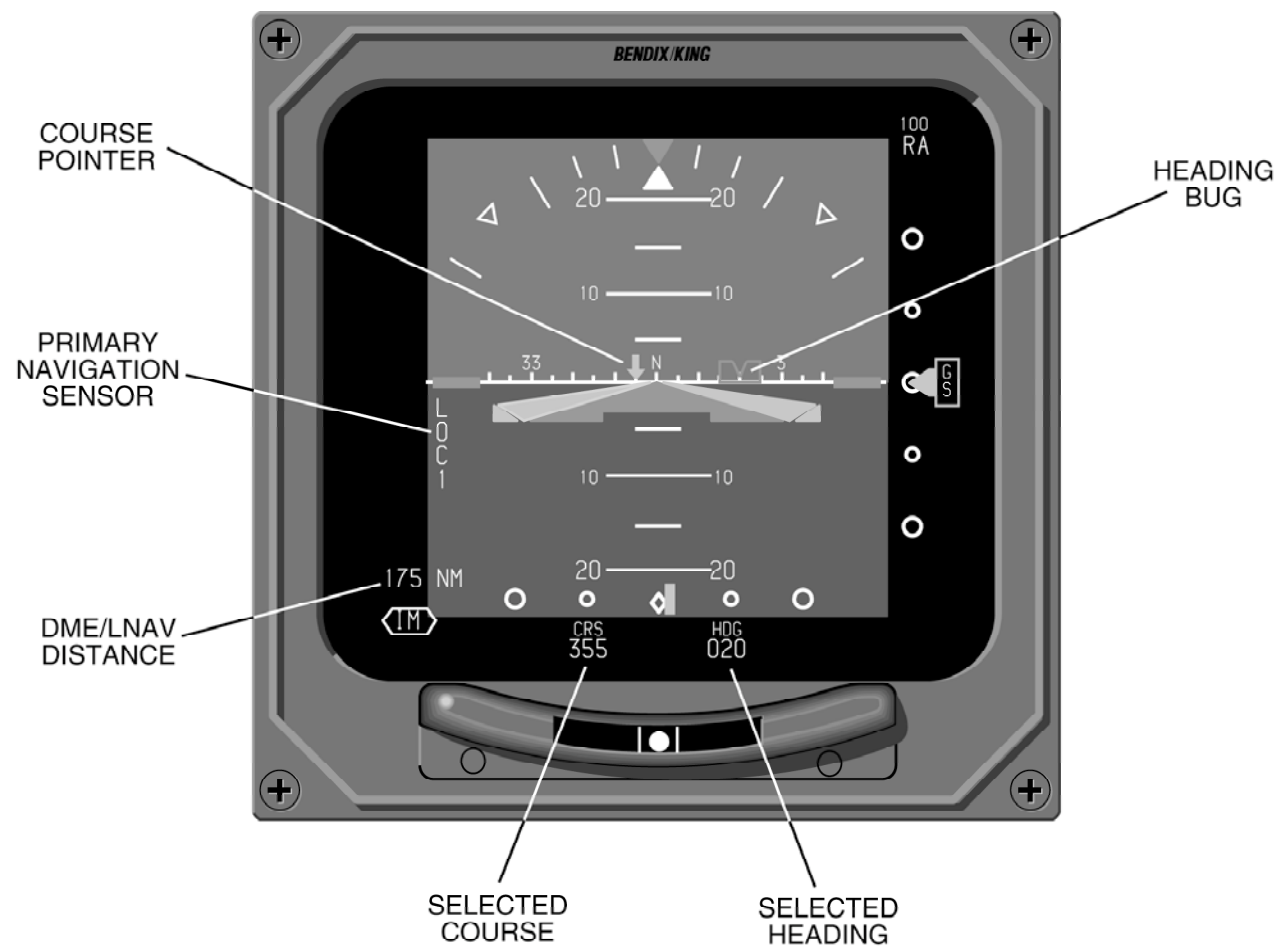

Figure 4.3.2
COMPOSITE APPROACH MODE DISPLAY

MFD DISPLAYS

Software versions 05 and above support the Multi Function Display (MFD) used in three and five-tube EFS 40/50 configurations. In traditional EFIS systems the MFD's primary purpose was to provide weather radar and/or LNAV or RNAV moving map information. In addition to providing the traditional display functionality, the MFD in EFS 40/50 systems also has the ability to function as an independent EHSI if the system is configured to provide such functionality.

In such cases, the information displayed on the MFD follows the same basic display format as the EHSI. Therefore this section will only address those areas of the MFD that differ from the EHSI.

Refer to Figure 4.4.1, 4.4.2 and 4.4.3 while reviewing this section.

CRS, NOT CRS SELECT

When the MFD course select knob is not active, a bar the color of the CRS annunciator will be placed above it. This will alert the pilot that the MFD CRS knob is not active and the MFD's course annunciator is referenced to the pilot's EHSI selected course.

Example: $\overline{\text{CRS}}$ 135

WEATHER ONLY

o A configuration option available at the time of installation and certification, provides a traditional

weather radar indicator display. Unlike most conventional EFIS weather radar displays this display will not present any non weather related information. All navigation information is removed, leaving a clean weather presentation consisting of four cyan range rings and white radar annunciators located in the lower left corner.

Weather radar mode, warnings and failure annunciators are displayed as they are on the normal EHSI ARC Weather mode.

w TRACK LINE

A yellow dashed line drawn from the center of the symbolic aircraft to the compass card or outer range ring. Activated and slewed by pressing one of the TRK buttons. Pressing the VP button will activate VP at the location of the Track Line. In the upper left corner a yellow digital readout displays the present position of the track line. Once the track line has remained stationary for 15 seconds it will be decluttered.

VERTICAL PROFILE (VP)

w SYMBOLIC AIRCRAFT

When the VP mode is selected for display, the symbolic aircraft is centered on the left edge of the display.

Beginning with software version 09, the Split Screen display is

activated by pressing the VP button while VP is active. Therefore, the VP button will provide the following selection sequence:

- Vertical Profile
- Split Screen
- Horizontal Scan Only

w **RANGE RINGS**

Four evenly spaced vertical cyan range rings are displayed during VP. At the bottom of each range ring, a cyan distance number is displayed announcing its range.

w **ALTITUDE LINE**

Three horizontal altitude lines are present on the VP display. The center line is off the nose (bore line) of the symbolic aircraft, representing the actual aircraft's present altitude. Equally spaced above and below the 0 foot center line are two altitude lines a certain number feet above and below the aircraft. The number associated with these lines varies with the selected range to compensate for the radar beam width at the various ranges.

w **PROFILE ANGLE**

In the upper left corner "PROFILE" is displayed announcing that the VP mode is selected. Just below it, the present azimuth angle being sliced is displayed as L (left) or R (right) followed by a number. "R6" would represent a VP slice being performed at 6 degrees right of the aircraft nose.

w **PLAN-VIEW, NORTH-UP MAP**

o Beginning with software 07, Plan-View is an option selectable at the time of installation. The Plan-View North-Up map mode provides a display in which a symbolic aircraft shows the actual aircraft's position relative to the LNAV flight plan route. As the actual aircraft progresses along the flight plan route or deviates from it, the symbolic aircraft likewise progresses along or deviates from the flight plan depiction on the indicator. Range is depicted by the dashed white full scale range ring and dashed light blue half scale range ring. When the Plan-View is first entered, the symbolic aircraft is positioned in the center of the display. As the actual aircraft moves, the symbolic aircraft will move about the display and may move off screen. If this occurs, the symbolic aircraft can be brought back onto the screen in any of three ways. One is by pressing the enter button. This will reposition the symbolic aircraft at the center of the display. Another method is to use the joystick to change the lat/long of the center of the screen (see Joystick operation in Section 2.4, MFD Operation). A third method is to select a greater range scale.

The Plan-View, always displayed as a true north map, aids in flight planning and aircraft position awareness. Weather radar, lightning and other navigation information are not available in Plan-

View mode.

To display the Plan-View, an LNAV with an active valid flight plan must be selected as the primary navigation source and be providing valid magnetic variation. The current FROM waypoint and the next 14 waypoints on the flight plan may be displayed. As defined for the normal NAV Map, the pilot may elect to display either the closest navaids or airports along with the first five flight plan waypoints.

CHECKLIST INTERFACE

In software 08 and higher a configuration option available at the time of installation and certification, provides Checklist display capability on the MFD. Checklist functions are controlled via the CP 469A, MFD Control Panel, buttons and joystick.

The user entered checklist data is organized in a simple page-oriented format with a programmable index function which allows quick access to the checklist entries. The index operates from user entered title descriptions and relative page numbers which provides maximum flexibility in organizing and titling the index items. It is also possible to create hierarchies of indices when desired. An additional capability is provided to allow invocation of emergency checklists through discrete signals applied on the rear connector. Any index or checklist page list can be mapped to any of the

eight emergency page inputs allowing a high degree of freedom in defining and organizing the operation of programmed field units. In addition to being able to program the index and emergency page operation, it is also possible to program the colors used for the text fields, title lines, and cursor lines for any indexed list.

All pages are organized as twelve lines of 32 characters each for a total of 384 characters per page. The CP 469A will store a minimum of 800 checklist pages and 400 note pages. Since the actual storage requirements vary according to the complexity of the pages themselves, the actual storage capacity will vary upward from this minimum. The upper limit for both checklist pages and note pages is fixed at 1024 each.

W *LOADING AND MODIFYING CHECKLIST DATA*

NOTICE

**THE USER IS SOLELY
RESPONSIBLE FOR
CHECKLIST CONTENT**

The user may load the CP 469A with predefined checklist data generated on an IBM™ compatible laptop PC using DEU (Data Entry Utility) software on a 3.5 inch disk, KPN 222-00337-xxxx, provided with the CP 469A. This disk contains a "read me" file with more detailed information on generating and modifying check-

list and note pages. The PC must have DOS version 3.0 or greater and should have at least 512 Kbytes of free RAM. A cable, KPN 155-02794-0002 is required to load the checklist data from the PC to the CP 469A via RS 232. Checklist data in the CP 469A can also be downloaded from the CP 469A to the PC where it may be modified and then re-loaded back into the CP 469A. User programmable note pages can also be modified with the use of the PC.

w **CHECKLIST PAGE ORGANIZATION**

Available colors are red, green, blue, cyan, magenta, yellow, and white. Black is reserved. On all index and checklist pages, the first two columns of characters are reserved for the cursor and checkoff status. A graphical cursor will move from item to item to let the user know which line the cursor is on. In addition, the color of the line with the cursor may change. A special character will be displayed in the first reserved column to indicate the checked status of a line. A blank will indicate that nothing within the sub-tree has been checked off, or that there is no element to be checked off. A star symbol will indicate that a list or sub-tree is partially checked off. A check mark will be displayed when all checklist items within a sub-tree have been checked off. These conditions may also involve a color change on the line.

The following sections describe the checklist pages. For a description of how the user moves from page to page, refer to the CONTROLS section.

w **ROOT INDEX PAGE**

Refer to figure 4.4.6. Upon selecting checklist for display, the CP 469A will transmit a 'root' index page to the EFS symbol generator for display. This 'root' page will include disclaimer text that states the user is responsible for the content and maintenance of data within the checklist. It will also contain user-supplied text to describe the checklist, to be used as a means to identify the source/creator/version of the checklist stored in CP 469A memory. In addition to the title and disclaimer lines, the root page will have index entries of two types: user-defined, and fixed.

The fixed entries will include a NOTES entry which allows access to the note page sub-tree, and another entry, CLEAR ALL CHECKLIST ITEMS, which allows the user to clear all checked items in the entire tree. These entries will always be present on the root tree, and will follow any user-defined index entries. The user is not required to have any NOTE pages, but the index entry will always be present.

The user-defined index entries may point to sub-index pages, or directly to a checklist. The user

is free to name these entries, and to determine their organization. Typically, the first entry on the root page would be 'EMERGENCY PROCEDURES', but the user is free to provide another organization. At least 4 such user-defined index entries will be provided on the root index page. The initial cursor position will always be at the first index entry in the root page. The cursor will be restricted to the six index entry lines.

The user will be able to specify the color of the top title lines, the color of each of the four user-assigned index items, the color of the cursor line, and the colors that each of the user-assigned index lines change to when all items in the sub-tree have been checked off or when a portion of them have been checked off. The color of the other lines are fixed.

w ***SUB INDEX PAGES***

Starting with the pointers associated with the root index page, sub-index pages can be created. These sub-index pages, or simply index pages, can have entries which point to either a list of checklist pages, or to another index page. Within a given level, the user can chain index pages together. For example, starting at one of the index entries on the root page, the user can create a collection of N index pages trailing off the entry on the root. Each index entry on the N index pages can in turn point to another

list of sub-index pages (or a list of checklist pages). The index pages form a hierarchy which can be nested arbitrarily deeply (subject to memory constraints). Each index page consists of a title line with relative page number indication, and up to eleven index entry lines. These index entries may span more than a single line, but may not cross page boundaries. As with the root index page, the first two character columns are reserved.

The user can select the color of the title line, and the color of each of the index entry lines. In addition, the color of the cursor line, the color of partially-completed items, and the color of fully-checked items can be specified.

w ***CHECKLIST ITEM PAGES***

Refer to figure 4.4.7. At the bottom of the checklist 'tree' are the checklist page lists. These pages contain individual checklist checkoff items. The items on these pages are either checked or unchecked.

The contents of checklist pages is similar in format to the index pages, but with some important differences. The title line consists of title text and a relative page number indication, as with the index pages. The checklist item portion consists of eleven lines of text, with the first two character columns reserved like the index pages. A checklist entry can span more than one line, but

cannot span across checklist pages.

The user may specify the color of the title line, the color of the cursor line, the color of the checked items, and the color of the unchecked items. Note that this implies that the unchecked color of each item cannot be selected separately. This helps to avoid color confusion within a checklist page. Also, each item is either checked or unchecked, so no partially-completed checklist items apply.

w **NOTE PAGES**

A separate portion of CP469A memory is reserved for the entry of data for reference by the flight crew, and can be modified separately from the checklist page data. The note page portion of memory will normally be small, allowing a quick update from the PC to that portion of checklist memory.

The DEU utility running on a PC is used to create note pages similar to the way the checklist is created. The NOTES entry on the root index page points to an index page listing entries for note page lists, or other note page index pages. Index pages in the note-page sub-tree are formatted just like regular index pages, except that the indicators for completed/partially completed lists will never appear. Only the cursor will appear in the first two character columns. The note pages themselves are similar in appearance to the checklist

pages. They have a title line with relative page numbering, and 11 lines of text.

The user may select the color of the note page title line, the color of the text on the page, and the color of the cursor line.

w **CLEARING CHECKLIST ITEMS**

There are two ways to quickly return all checklist items to the unchecked state. The first is to remove power from the CP 469A for more than 15 seconds. The second is to move the cursor over the CLEAR ALL CHECKED ITEMS on the root index page, and press the ENTER key. This will cause a warning page to be displayed, with instructions on what to do to clear all the checked items.

The ENTER key can be used to uncheck individual checklist items by placing the cursor on a checked item and then pressing ENT.

w **EMERGENCY PAGE ACTIVATION**

The CP 469A provides eight prioritized discrete lines for emergency page use. Using the PC, the user can bind these active low inputs to specific checklist pages, which can be tailored to the nature of the emergency discrete. Any discrettes which are not bound using the PC will be ignored by the CP 469A.

Whenever one of these inputs

goes low while checklist mode is active, the checklist unit will automatically display an emergency summary page listing all currently active emergencies, and the title of the list that the emergency is bound to. The user may select the emergency of choice, and press the ENTER button. Control is then transferred directly to the emergency list desired. As soon as the user checks off all items associated with a given active emergency, the checklist unit will again display the emergency summary page, showing that emergency condition as checked-off. This allows the user to know when all the checklist items associated with an emergency have been checked off, and allows an easy way to proceed to the next active emergency, if one exists.

If an emergency discrete activation is detected by the CP 469A while the checklist mode is not active, a yellow "C-L EMER" message will be displayed on the MFD. When the user presses the CHK LIST button to activate the checklist mode, the checklist unit will display the emergency summary page as described above. This provides the pilot/copilot with an easy means to determine the source of the emergency discrete (the name of the checklist it is tied to will appear on the emergency summary page) and to proceed to check off the items associated with that emergency. Once all the items associated with a given emergency are checked off, the

checklist unit will consider that emergency 'handled', and will remove the request for the "C-L EMER" message. However, if a given emergency discrete is re-applied after all items associated with that emergency have been checked off, the checklist unit will again notify the user that a given emergency has re-occurred via the emergency summary page.

The CRS/SEL button can be pressed to display the emergency summary page any time the checklist mode is active. A second press of the CRS/SEL button at this time, returns the previously displayed checklist page. While the emergency summary page is displayed, the 1-2 key can be used to display a list of all the emergencies that were mapped to an emergency discrete.

w CHECKLIST CONTROLS

Checklist: CHKLIST

Selecting the CHKLIST button activates and deactivates the checklist function and causes the information to be displayed on the MFD. The checklist will provide approximately 800 pages of normal, abnormal, and emergency data.

Joystick

The joystick can be moved side to side, up and down, and to the 45 degree points. The 45 degree points will be ignored in checklist mode.

Joystick position data will be transmitted continually to the

EFS MFD for use in MAP processing, and will be used by the CP 469A processor to enable movement through checklist pages (when the CP 469A is in checklist mode).

A downward push on the joystick will cause the cursor to move down one line or item in the checklist. The line down operation advances from one index/item page to the next, and wraps within one level. Holding the joystick down continuously will cause the cursor to slew down.

An upward push on the joystick will cause the cursor to move up one line or item in the checklist. The line up operation advances from one index/item page to the previous page, and wraps within one level of pages. Holding the joystick up continuously will cause the cursor to slew up.

A rightward push on the joystick will cause the cursor to go to the top of the next page. The next page operation applies only within a single level, and wraps to the first page within a level. For example, a rightward push while on the last page of a list of checklist pages will move the cursor to the top of the first page in the list. Holding the joystick right continuously will cause the cursor to slew forward through the pages.

An leftward push on the joystick will cause the cursor to proceed to the top of the currently selected page, and subsequent leftward pushes will move the cursor to

the top of the preceding pages. Paging is within a single level, and wrapping from the first to the last page within a level will be supported. Holding the joystick left continuously will cause the cursor to slew through the pages in reverse.

Enter : ENT

The state of the ENT key is continually transmitted to the EFS for MAP processing use, and is also used by the CP 469A for checklist purposes.

When in the checklist mode, the enter button will behave differently depending on where in the checklist the cursor is located. The general behavior of the ENTER key is to enable the pilot to check off everything in the checklist by using the ENTER key alone. In the checklist pages, pressing enter on an unchecked item will cause the cursor to check off that item and proceed to the next unchecked item in the list. If no unchecked items exist between the cursor position and the end of the list of item pages, the cursor is placed on the first unchecked index entry of the parent index list. If no unchecked index entries exist at that level, the search continues up the checklist tree until an uncompleted index entry is found, or until the cursor reaches the root index page. If the item is checked off and the enter button is depressed, the line will be unchecked and the cursor will remain at the line just unchecked.

When on an index page, pressing the enter button will cause the cursor to move to the next unchecked item or index entry it finds. If the entry is not fully completed, the cursor is moved to the next lower level, and parked on the first uncompleted item/entry on that level. If the index entry that the cursor is on is already fully checked-off, the cursor first searches the current list of index pages for an unchecked index entry, and then searches all the layers of index pages upward, toward the root index page, always looking for an incomplete checklist. If all items are checked off, the cursor moves to the top of the root index page.

On the root index page when the cursor is on the "CLEAR ALL CHECKED ITEMS", pressing the enter button will cause a warning page to come up asking for verification that the pilot truly wants to clear all checked items. An additional push on this screen will cause all checked items to be cleared.

HSI

The HSI button will not function while the checklist is active.

ARC

The ARC button will not function while the checklist is active.

NAV

The NAV button will not function while the checklist is active.

Up Arrow

When in checklist mode, an up-arrow (range-up) push will serve to move the cursor up the 'checklist tree'. That is, if the cursor is on a checklist page, a range up will move the cursor to the index page entry used to access that list. When the cursor is positioned over an index page entry, the cursor will move to the index page and entry from which the current index entry is accessed. A range up push on the root index page has no effect, since no higher level exists to go to.

Down Arrow

When in checklist mode, the down arrow (range down) will move the cursor down the 'checklist tree' by moving the cursor into the branch accessed through any index page entry. A range down push while the cursor is on a item page has no effect, since there are no 'lower' levels to go to.

1-2

When checklist mode is active, the 1-2 key normally will not be active. However, if the active emergency summary page is currently displayed, the 1-2 key will cause the checklist unit to display an informational page listing all currently 'bound' emergency discretetes. This page lists all eight emergency discretetes, and the title of the checklist page that each was bound to using the DEU utility software.

RMI 1

The RMI 1 button will not function while the checklist is active.

RMI 2

The RMI 2 button will not function while the checklist is active.

CRS (NOT) SEL

When in checklist mode, the CRS(NOT) button will cause the checklist unit to display the list of active emergencies. A second press returns the previous display.

TST REF

When in checklist mode, the TST REF button will cause the checklist unit to display a 'canned' help page. This help page can be used by the pilot/copilot to remind them what button combinations are used in checklist mode. This

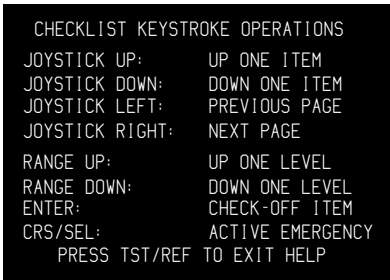

help page will appear as follows:
CRS Knob

The CRS knob will not function while the checklist is active.

REMOTELY MOUNTED SWITCHES

The following functions of the CP

469A can be implemented with remotely mounted switches wired to the rear connector.

- Up Arrow : EXT UP
- Down Arrow : EXT DWN
- Enter : EXT ENTER
- Joystick

FAULT ANNUNCIATIONS

There will be two possible control panel faults that will get displayed on the MFD display if the control panel fails. One fault is the normal red CP fault caused by a mode line failure. The second fault is a red CCP fault caused by a failure in the checklist control panel processing. The faults to be detected by the CP 469A to cause this annunciator include the following:

1. CPU test failure
2. ROM test failure
3. RAM test failure
4. Stuck joystick or control panel key
5. Invalid data in checklist/notes EPROM (checksum failure). This fault condition applies only if the EPROM chip is NOT completely erased. That is, if the checksum test on EPROM chip data fails because the chip is erased, a CCP fault should NOT be raised. This is because the CP469A will come from the factory with the EPROM chips erased, and it is undesirable for the product to show a fault straight out of the box. Only if at least one of the bits in the EPROM are programmed, and the EPROM checksum test fails will a CCP fault be

generated.

TCAS INTERFACE

With software 08 and higher a configuration option available at the time of installation and certification, provides a TCAS ONLY traffic display on the MFD. A "TRAFFIC" message is provided if TCAS is configured for the pilot and co-pilot EHSI displays during an active TA or RA, but intruder traffic will not be shown on these displays, only the MFD.

Range control will be retained by the CP 469A MFD control panel. Above/norm/below and actual/relative altitude selections will be made on the TCAS control panel.

Resolution advisory (RA) information such as a climb arrow will not be shown on the MFD. RA traffic will be displayed with TCAS II, but not TCAS I.

Whenever a normal operating mode that does not display TCAS traffic information is selected on an MFD display, "TRAFFIC" will be annunciated to indicate that a TA or RA is in progress. This annunciation will remain on non-TCAS displays as long as at least one TA or RA is active.

All RA, TA, and PROXIMATE TRAFFIC will be displayed on the MFD when TCAS is configured and TCAS ONLY is selected, regardless of display format and altitude limits. OTHER TRAFFIC

within the selected altitude limits will also be displayed when possible. The EFS 40/50 will display up to 20 TCAS intruders on the MFD.

w TCAS ONLY SELECTION

With EFS software 08 and later, a dedicated TCAS select push button on the CP 469A MFD Control Panel labeled "TCAS ONLY" will provide 360° TCAS ONLY (range = 5 nm) on the MFD with a single selection. This momentary switch will alternately select TCAS ONLY and last display mode. The last display mode will be restored exactly, including previous range and map format.

TCAS and checklist are mutually exclusive modes that will cancel each other such that only the most recently selected will be active.

Default conditions at selection:

- 360° format
- 5 NM range
- All intruders displayed (20 max.)

Operation while selected:

- Ranges available: 2, 5, 10, 20, 40 NM

- 360° format only
- TST/REF, NAV, RMI 1, RMI 2, ENT, JOYSTICK and 1/2 buttons are inactive

De-selection:

- The dedicated TCAS ONLY select always returns to the last

display mode.

w **TCAS DISPLAY FORMAT**

TCAS ONLY display will be 360° format and normally contain the following elements:

- * Small cyan symbolic aircraft symbol located in the center of the 360° TCAS ONLY display.
- * Two NM range ring consisting of cyan dots positioned every 30 degrees to represent the 12 clock positions. Presented on 2NM (after software 10), 5 NM and 10 NM ranges only.
- * Full range ring consisting of cyan radial tick marks positioned every 30 degrees to represent the 12 clock positions plus intervening cyan dots every 10 degrees.
- * Map type half range ring (white dashes) without range annunciation on 20 NM and 40 NM ranges.
- * "TCAS" annunciation in vertical field in place of nav source.
- * TCAS mode annunciation.
- * TCAS range annunciation.
- * Up to two no-bearing intruder messages.
- * Above/norm/below annunciation.
- * Actual intruder altitude and (FLXXX) annunciation when appropriate.
- * TCAS traffic symbols (intruder, data tag, and vertical speed arrow).

w **TCAS TRAFFIC SYMBOLOLOGY**

Each intruder symbol will be accompanied by a data tag and,

when appropriate, a vertical speed arrow. The data tag and arrow will be the same color as the intruder symbol that they are associated with. The intruder symbol, data tag, and vertical speed arrow will appear the same size regardless of range selection.

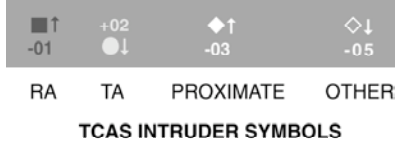

Note: RA traffic is not provided with TCAS I.

Traffic generating a Resolution Advisory (RA) will be displayed as solid red squares. Traffic generating a Traffic Advisory (TA) will be displayed as solid yellow circles. Proximate traffic will be displayed as solid white diamonds. All other, no threat traffic will be displayed as hollow (outline only) white diamonds. Intruder symbols are centered on the actual intruder location.

Vertical Speed Arrow

The vertical speed arrow will be positioned immediately to the right of the intruder symbol when the intruder vertical trend is climb or descend as reported by the TCAS processor. The arrow will point up for climbing traffic and down for descending traffic.

Data Tag

The data tag will normally consist

of a + or - followed by two digits of altitude difference (relative altitude) in hundreds of feet between the intruder and own aircraft. (+ = intruder above own aircraft) During selection of actual altitude, and with a valid source of own altitude provided by the TCAS processor, the data tag will consist of three digits representing hundreds of feet above MSL. Actual altitudes below sea level will be displayed as two digits preceded by a minus sign. The data tag will be centered on the intruder symbol and positioned above it when the intruder is above own aircraft. The data tag will be positioned below the intruder symbol when the intruder is below own aircraft. The relative altitude data tag for intruders at the same altitude as own aircraft will consist of "00" without a + or - sign and be positioned to indicate the intruder's most recent altitude deviation from own aircraft. When no altitude trend information is available, the "00" is positioned below the traffic symbol.

Off-Scale Traffic

RA and TA traffic that is located beyond the selected range of a TCAS display will be shown as one half of the appropriate intruder symbol located on the outer edge of the displayed area at the proper bearing. A data tag and/or vertical speed arrow associated with this intruder will retain its normal position relative to the intruder symbol and only that portion (if any) within the normal

display area will be visible.

w TCAS DISPLAY ANNUNCIATIONS

Traffic

During an active RA or TA, a "TRAFFIC" message will be annunciated in large text on all EFS displays configured for displaying TCAS traffic but with TCAS de-selected. This annunciation will be provided for all normal operating modes, but not while maintenance or configuration pages are displayed. "TRAFFIC" will be red during an active RA and yellow during an active TA (an RA has priority over a TA). This annunciation will not be made while TCAS is selected for display. Beginning with software 0802, the "TRAFFIC" message will be replaced by a "NO TCAS " message for 15 seconds following a TCAS failure or a change of TCAS mode to Standby.

Note: *A remote annunciator may be included in some installations to provide full time TCAS operational status.*

TCAS

TCAS ONLY format will include a cyan "TCAS" displayed in the vertical field where the selected

MFD Displays

navigation source is normally displayed in other modes.

TCAS Status

TCAS mode, range, above/norm/below selection, and actual altitude (FL) selection will be presented in the bottom right corner of the display normally used for the RMI 2 pointer annunciations. FLxxx and

CONDITIONS			TCAS ANNUNCIATION						
ABOVE BELOW SELECT	REL or ACTUAL ALT SELECT	Valid Altitude provided	TCAS MODES (Display priority)						
			TA/RA (7)	TA ONLY (6)	TCAS STBY (5)	NO TCAS (4)	TCAS FAIL (3)	TD FAIL (2)	TCAS TEST (1)
Normal	Relative	X	TA/RA	TA	TCAS STBY	NO TCAS	TCAS FAIL	TD FAIL	TCAS TEST
Above	Relative	X	TA/RA ABV	TA ABV	TCAS STBY	NO TCAS	TCAS FAIL	TD FAIL	TCAS TEST
Below	Relative	X	TA/RA BLW	TA BLW	TCAS STBY	NO TCAS	TCAS FAIL	TD FAIL	TCAS TEST
X	Actual	YES	TA/RA FL123 †	TA FL123 †	TCAS STBY	NO TCAS	TCAS FAIL	TD FAIL	TCAS TEST
X	Actual	NO	TA/RA FL--- †	TA FL--- †	TCAS STBY	NO TCAS	TCAS FAIL	TD FAIL	TCAS TEST

ANNUNCIATION COLOR * ** CYAN ***YEL YEL YEL CYAN

X = Doesn't matter.

*TA/RA will be cyan. FL 123 will be white when a valid altitude is available, otherwise FL--- will be yellow. ABV and BLW will be cyan.

**TA (for TA ONLY mode) will be yellow during an active TA and cyan otherwise. FL123 will be white when a valid altitude is available, otherwise FL--- will be yellow. ABV and BLW will be cyan.

***NO TCAS is cyan with software versions prior to 10 and changed to yellow with version 10.

† FL xxx is only displayed for 15 seconds following a request for actual altitude, however, during those 15 seconds, FL has priority over ABV or BLW. The dashes after 'FL' were added by software 10 to indicate that valid altitude is not available.

TCAS STATUS ANNUNCIATION

ABV/BLW are both provided in the same five character field when specific conditions are satisfied as shown in the following table.

TCAS Mode

TEST - Indicates that the TCAS processor is performing system test.

TD FAIL - Indicates that the capability of the EFS to properly display TCAS traffic is suspect.

TCAS FAIL - Indicates that the TCAS processor (or a TCAS antenna) has failed.

NO TCAS - Indicates that a TCAS system component (other than TCAS processor and TCAS antenna) has failed.
TCAS STBY - Indicates that TCAS has been intentionally placed in standby mode.

TA - Indicates that TA ONLY mode has been entered by the TCAS processor.

When displayed, the annunciation color will be yellow if any intruder is a Traffic Advisory (TA). The color will be cyan when there are no intruders classified as a TA.

TA/RA - Indicates normal operation for TCAS II. This annunciation will not appear when TCAS I is installed.

Range

Range is annunciated in cyan without an alpha prefix immediately to the left of the TCAS status information. The ranges available are 2, 5, 10, 20, 40.

Above/Norm/Below

All TCAS displays will annunciate a cyan "ABV" or "BLW" when above or below respectively are selected on the TCAS controller. Neither annunciation is provided when normal is selected. This same three character field is also used to present own aircraft altitude when actual altitude (FL) is selected. The FL annunciation has priority over ABV and BLW.

No-Bearing Traffic

During any TCAS display, up to two no-bearing traffic messages may be required. The format for these messages is "TA 5.7NM/-06↑" or "RA 0.8NM/+01↓" where -06 and +01 are the relative altitudes of the intruder aircraft. Relative altitudes (including the + or - sign) will be replaced by a 3 digit actual altitude in hundreds of feet whenever the conditions for display of actual altitude have been satisfied. RA messages will be red and TA messages will be yellow. The vertical speed arrow, when climb or descend is indicated, will be displayed immediately to the right of the altitude digits.

FLXXX and FL

A white FLXXX is annunciated only when actual intruder altitude (FL) is being displayed. This annunciation will be absent when relative intruder altitudes are displayed. XXX will be own aircraft actual altitude in hundreds of feet as provided. This annunciation will be "FL---" (dashes added by software version 10) in yellow when actual altitude has been selected but a valid source of own aircraft actual altitude is not provided by the TCAS processor. Negative actual altitudes will be displayed as two digits preceded by a negative sign. (FL-XX)

Note: At the time of this publication, TCAS displays in conjunction with other display formats has not been certified.

EGPWS INTERFACE

o Beginning with software 14, a configuration option available at the time of installation and certification provides an EGPWS terrain display on the MFD.

w **EGPWS SELECTION**

Beginning with EFS software 14, a dedicated Terrain Select push button determines whether Weather or Terrain data is shown on the MFD.

When EGPWS is manually selected via the Terrain Select pushbutton, the terrain data will be displayed in the currently selected HSI/ARC format.

When EGPWS is automatically (pop-up) selected, the display will change to:

ARC format, 10 NM range

Automatic selection (pop-up) is initiated by the EGPWS detecting a terrain Warning or Caution condition and setting a pop-up discrete. Pop-up is monitored only when the terrain is selected.

Upon deselection of Terrain mode, weather data will be redisplayed in the current HSI/ARC format. The previous scan angle for weather will be restored. If VP or SS was selected prior to terrain selection, VP or SS display

mode will be restored.

w **EGPWS DISPLAY FORMAT**

Terrain display will show 180° of scan angle and normally contain the following elements:

- * Mode/status annunciation.
- * Range annunciation.

w **EGPWS MODE/STATUS**

EGPWS mode will be presented on three lines in the bottom right (or left, as configured) corner of the display.

The first line will be a white TERR annunciation. Lines two and three each may be a six character text message annunciating the current EGPWS mode/status.

TEST - EGPWS processor is performing system test.

TERR FAIL - EGPWS processor is no longer communicating with the EFIS system.

TERR RANGE EXCEED - A range greater than 320 nm is selected.

TERR RANGE FAULT - Indicates a mismatch of the specified range between the EFIS CP and the 453 data.

EGPWS PEAKS ELEVATION - Maximum peaks elevation displayed over minimum peaks elevation.

w **EGPWS RANGE**

Range control will be retained by

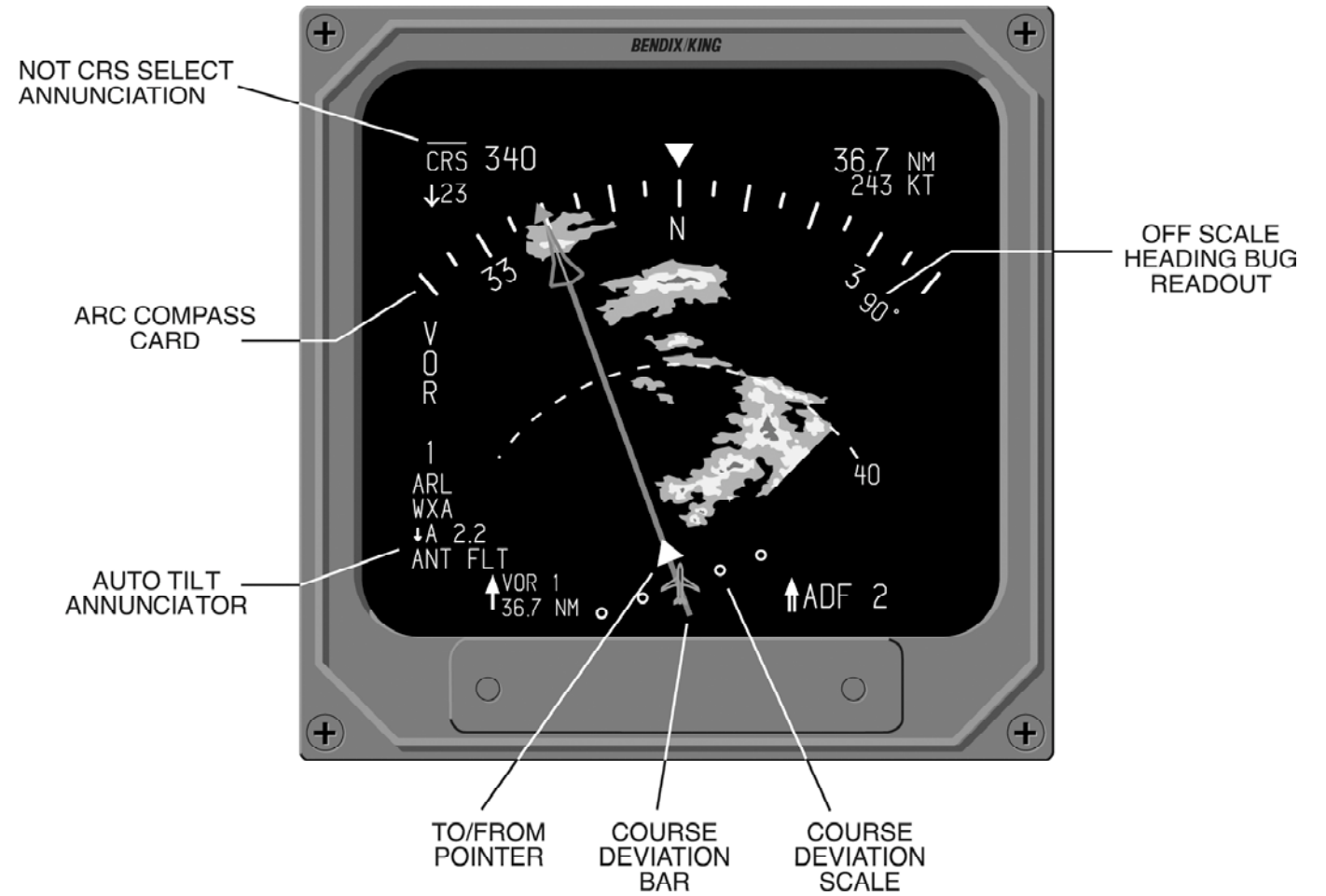

Figure 4.4.1
MFD ARC COMPASS + WX SYMBOL DEFINITION

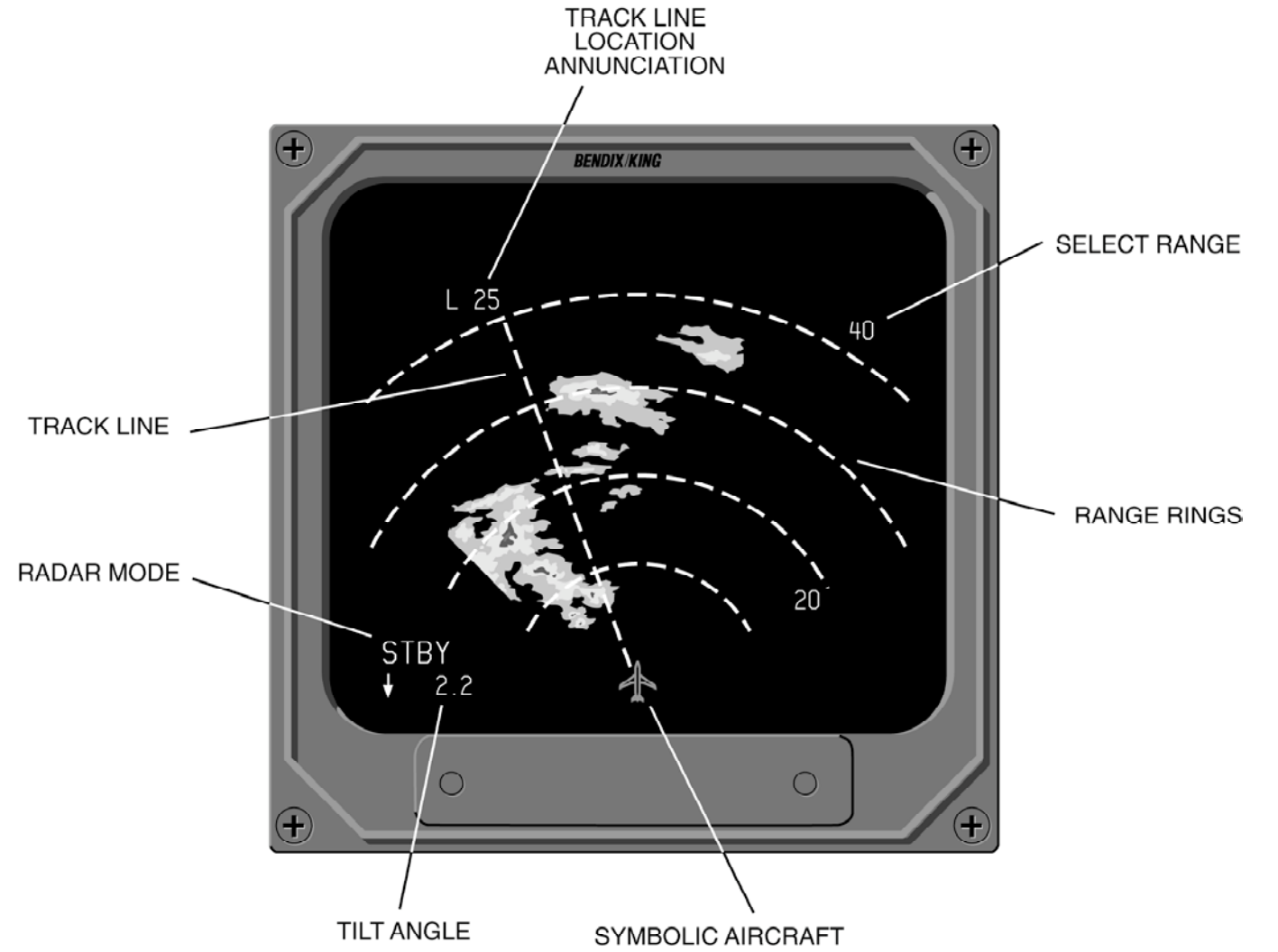

Figure 4.4.2
MFD WEATHER ONLY DISPLAY

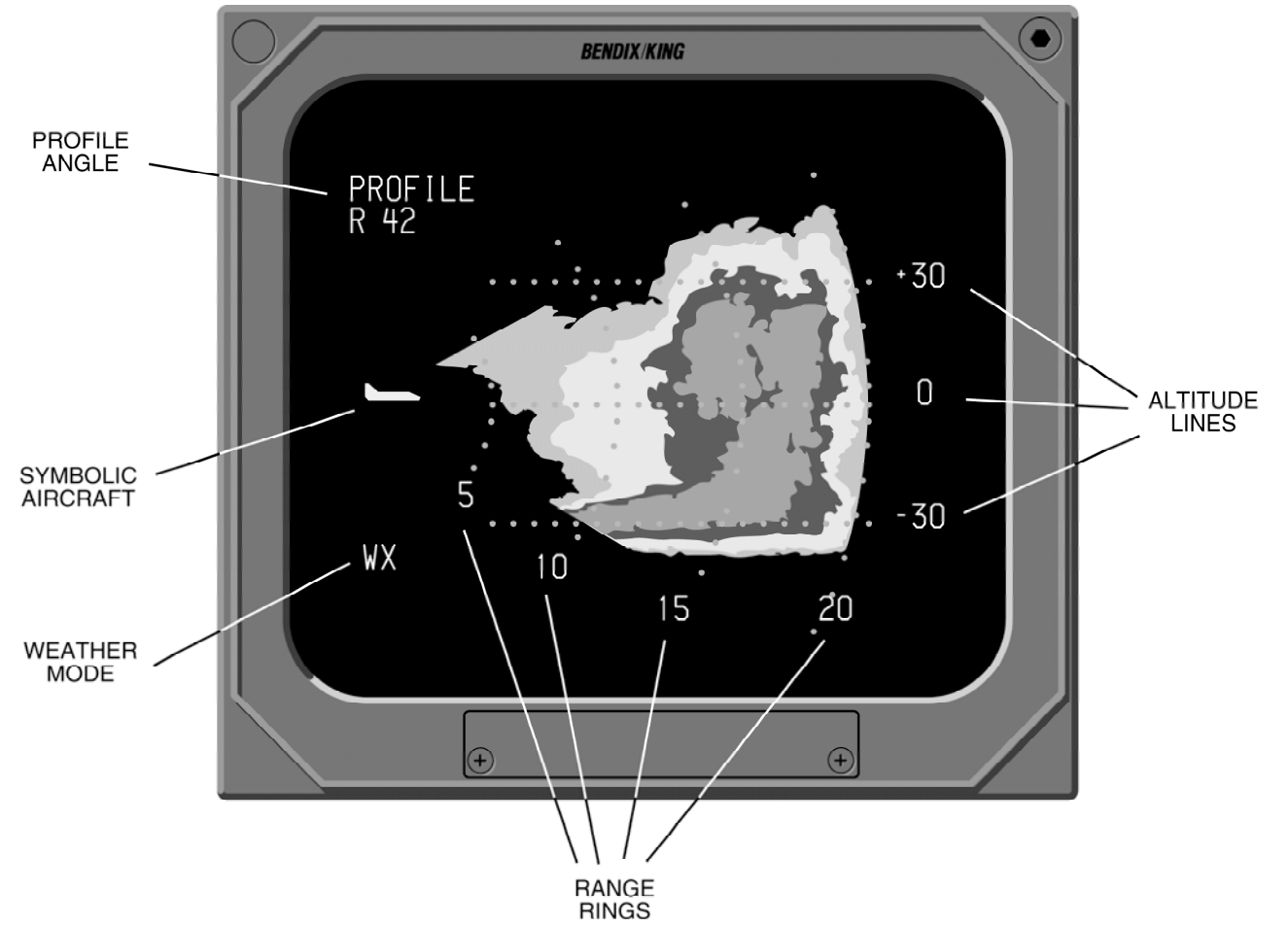

Figure 4.4.3
MFD VP DISPLAY

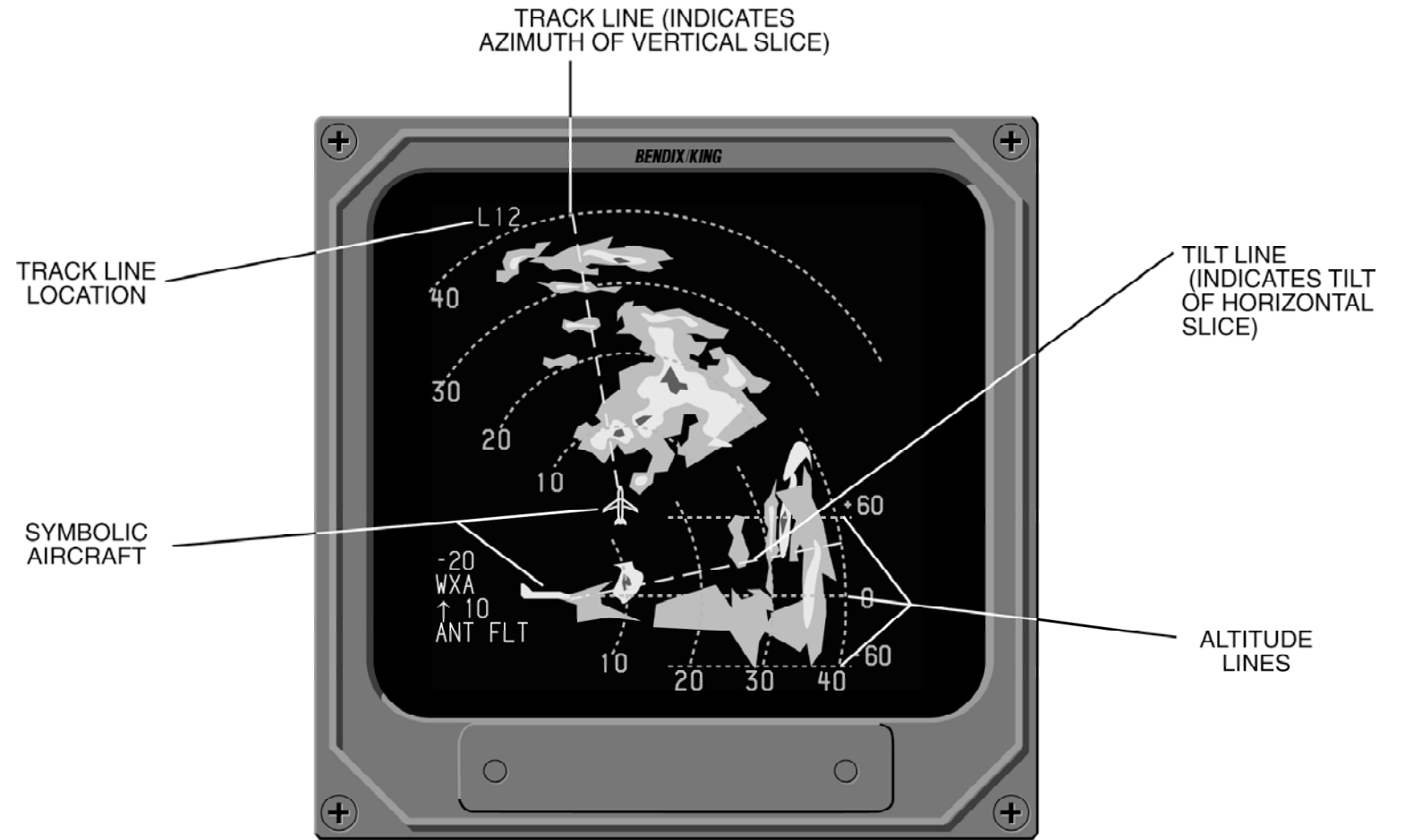

Figure 4.4.4
MFD SPLIT SCREEN DISPLAY
(NOTE: SW 09 and later)

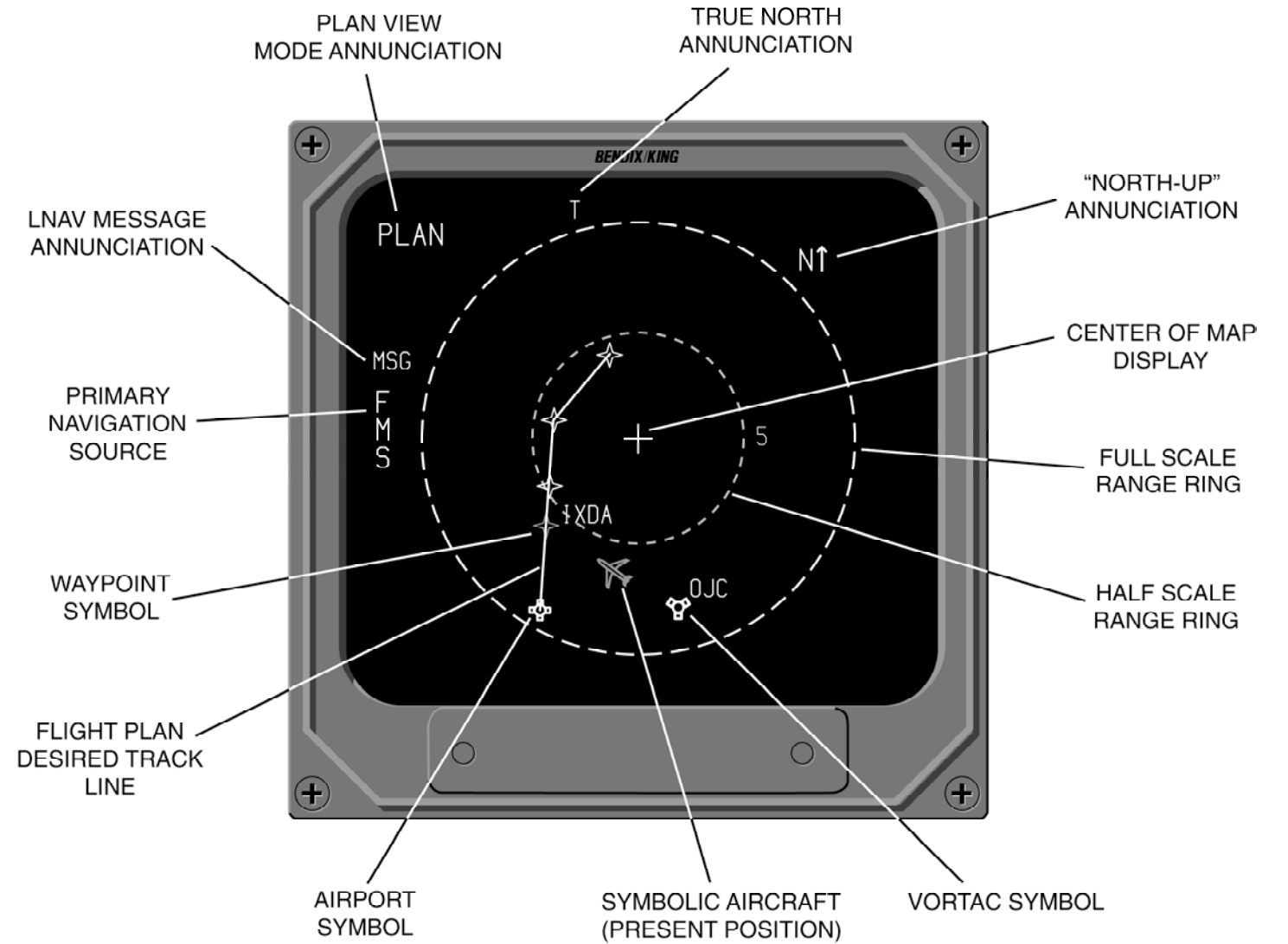

Figure 4.4.5
MFD PLAN VIEW DISPLAY

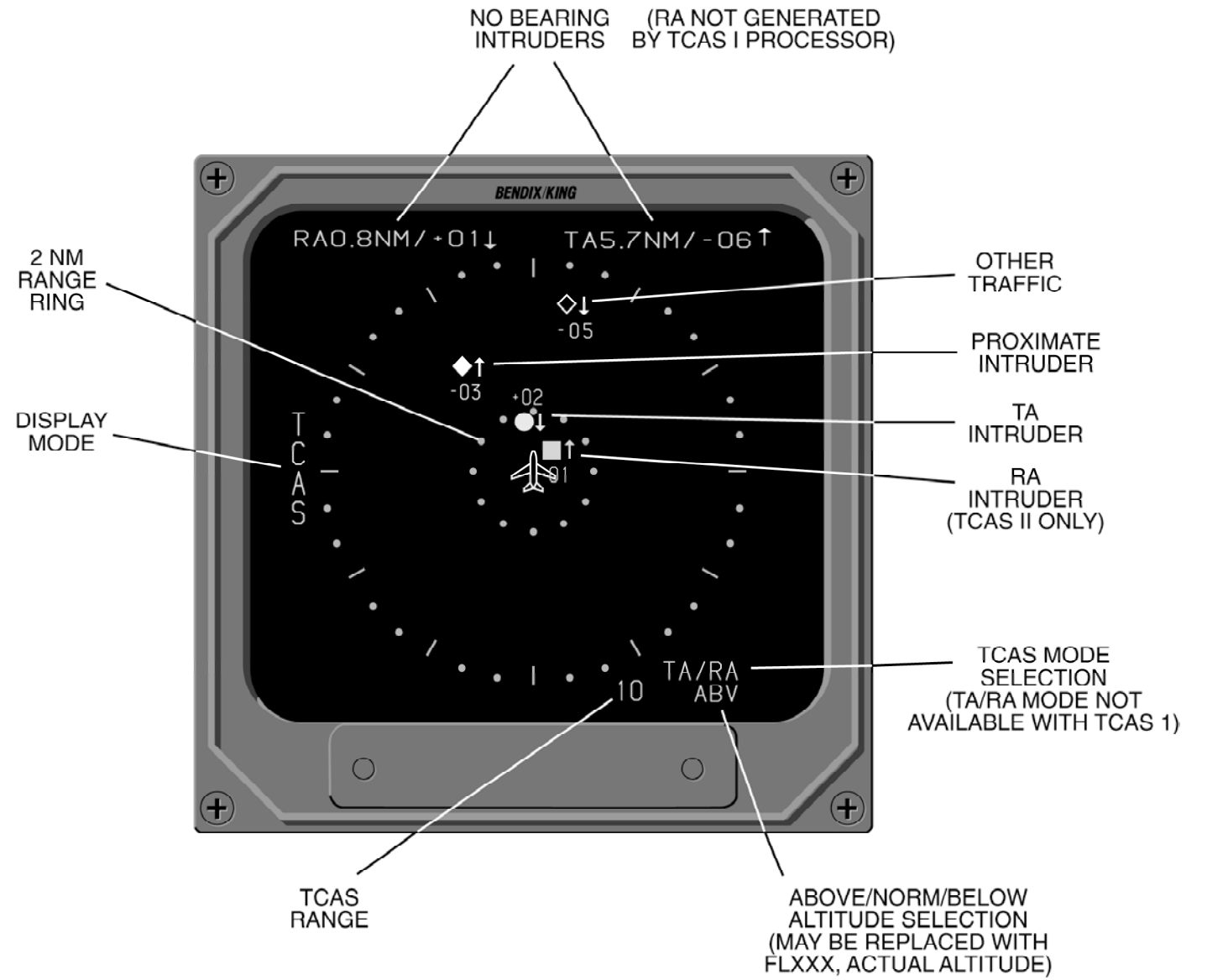

Figure 4.4.6
TCAS ONLY DISPLAY

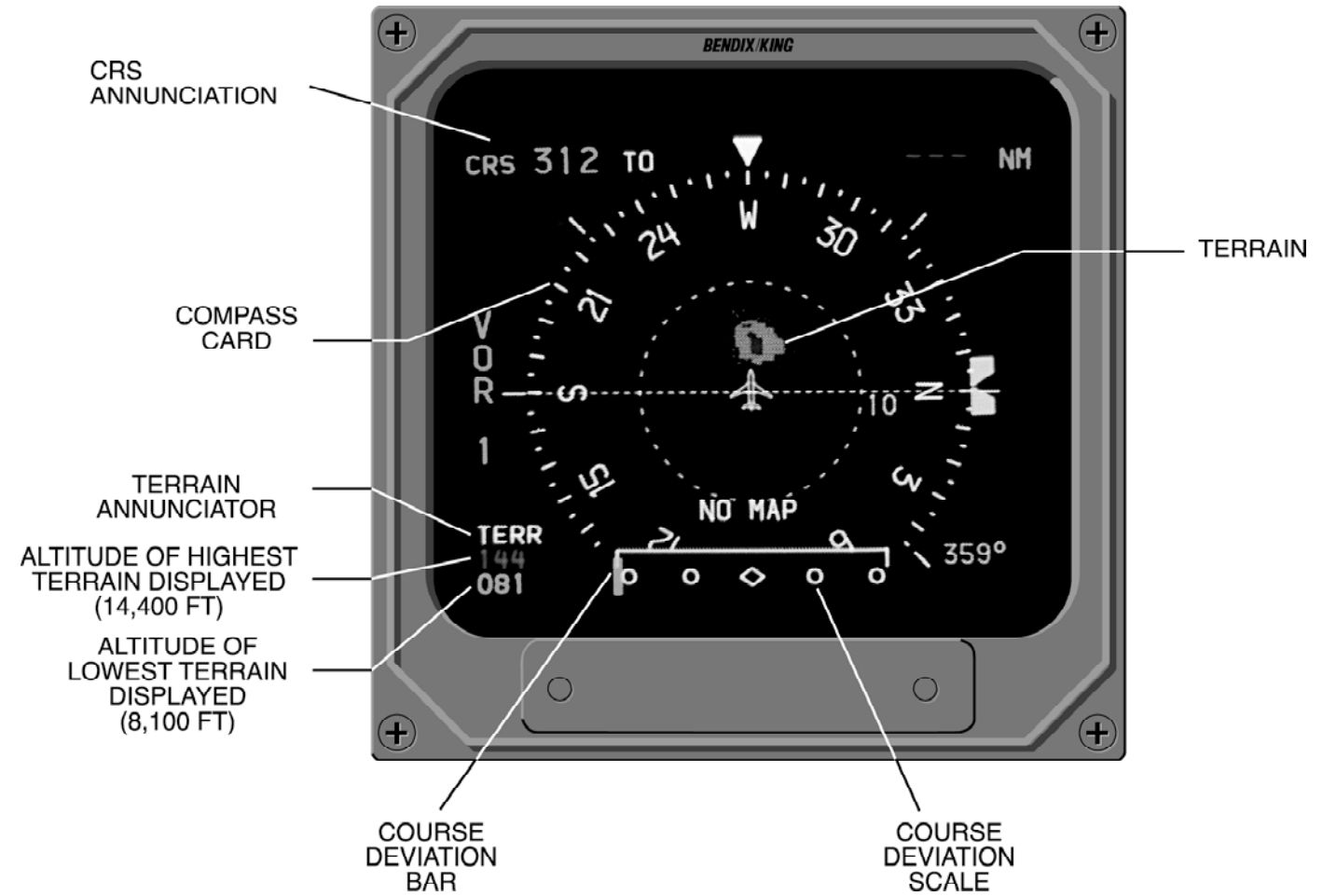

Figure 4.4.6a
EGPWS DISPLAY

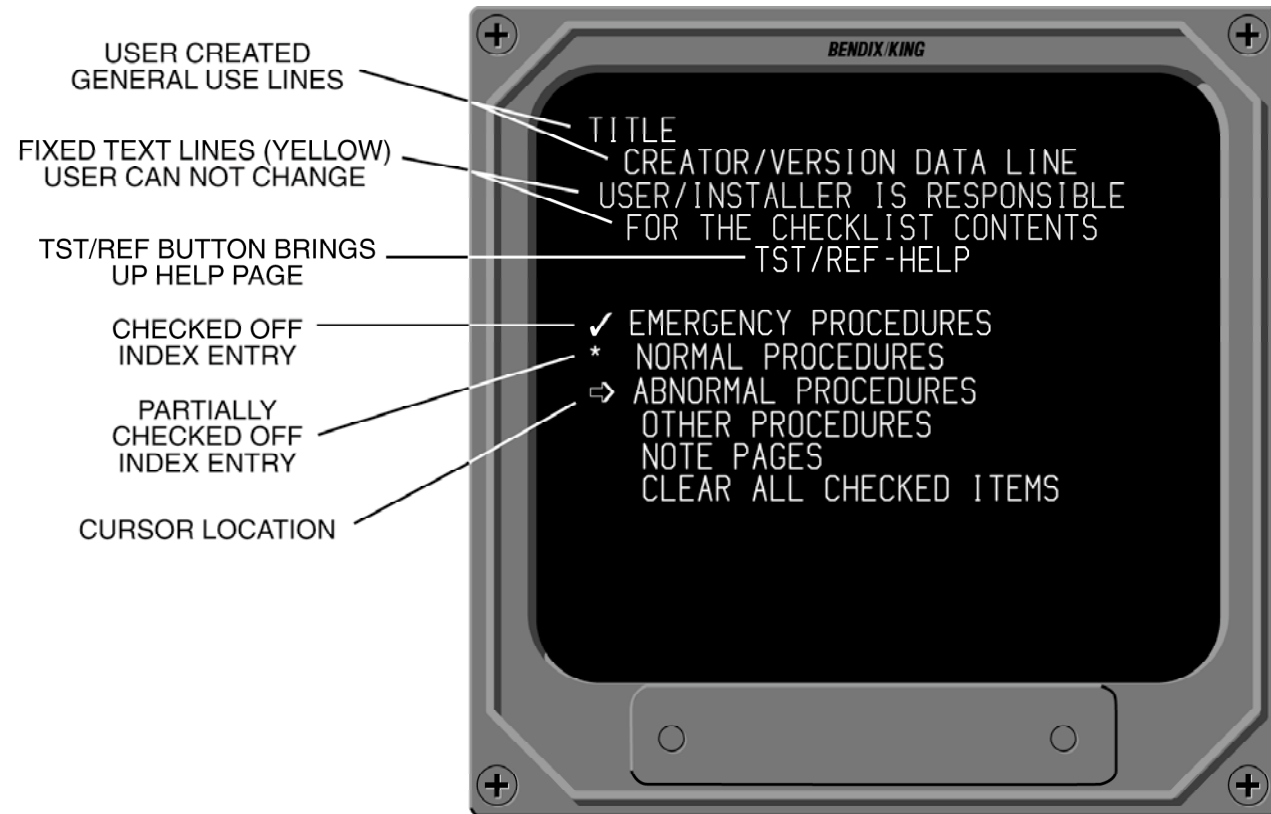

Figure 4.4.7
MFD CHECKLIST ROOT INDEX PAGE DEFINITION

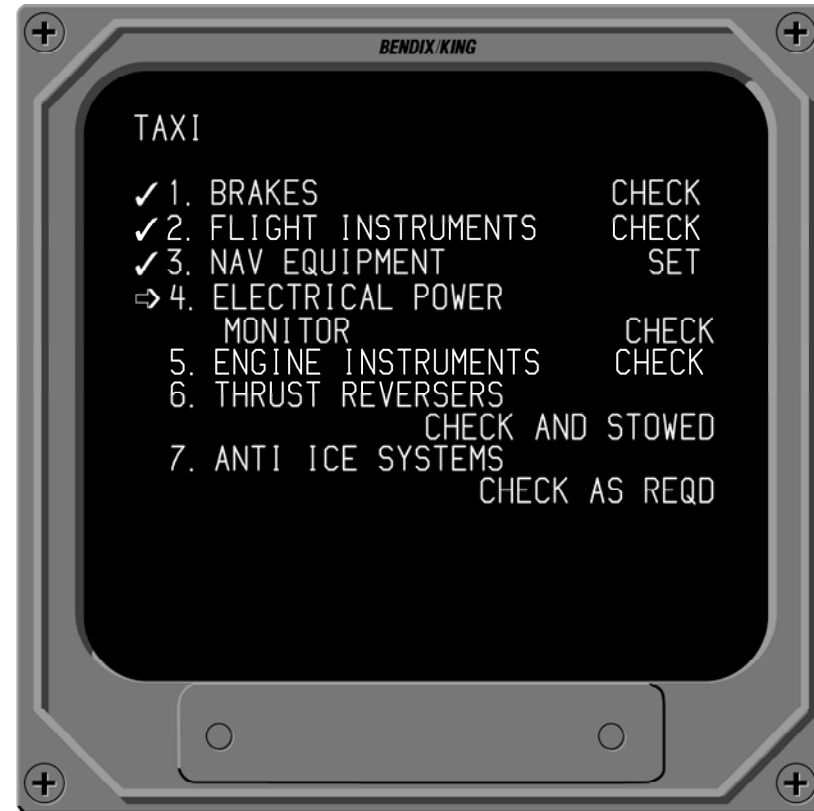

Figure 4.4.8
MFD CHECKLIST SAMPLE PAGE

OPERATING INSTRUCTIONS

Consult Aircraft Flight Manual Supplement for specific procedures and limitations in operation.

PREFLIGHT PROCEDURES

w **START UP**

At engine start, power should not be applied to the EHI 40/50 system, low voltage may turn the EFS 40/50 system off momentarily, and transient voltages may induce premature failures. With engines operating, turn on gyros and flight control systems, turn on avionics master switches to include the EFS 40/50 master, and turn on NAV systems to remove the EHSI flags.

When power is initially applied to the EFS 40/50 system, various flags maybe annunciated on the display, representing systems not yet operational.

w **SELF TEST**

Adjust BRT control on the EFS 40/50 CP 467, CP 468 or ED 461 and CP 470 for the desired brightness.

After a short warm-up time, press and hold the TST/REF button for three seconds to display the SELF TEST. A SELF TEST PASS or SELF TEST FAIL message will be annunciated. If the

system is operating properly the SELF TEST PASS message will be annunciated. If a malfunction exists, SELF TEST FAIL will be annunciated and the system should be serviced. Refer to figure 5.1 and 5.2, Self Test annunciation. Additionally, the pilot should ensure that the compass scale is white, which indicates that all three colors are operational in the display unit.

Note: *Performing the EFS 40/50 Self Test is not required at anytime. If a failure was to occur or exist, the small RED SG in a red box would be displayed. This test is intended to familiarize the pilot with the various flagging methodology used and a quick check for proper color presentation.*

The EADI self test page will automatically revert to a normal EADI display. After software 07, the EHSI will also automatically revert to normal operation from the self-test page after five seconds.

w **PUSH BUTTON TEST**

Check each push button function on the EFS 40/50 control panel. Push button operation should be as described in 2.1 EHSI Operation, 2.2 EADI Operation, 2.3 RADAR Operation and 2.4 MFD Operation.

PRE-TAKEOFF PROCEDURES

After the system test has been completed, select the desired Primary NAV sensor with the NAV source select push button. Set the desired course and heading, and check that the appropriate display is present on the indicator. Set the desired NAV frequencies for the departure phase of the flight. Then press the appropriate push buttons (HSI, ARC, BEARING #1, BEARING #2, etc.) on the EFS 40/50 control panel for the desired display presentation.

IN-FLIGHT OPERATION

Select the desired type of NAV sensor for the primary NAV display by pressing the NAV push button until the desired source is annunciated.

Select NAV system #1 (left) or #2 (right) by pressing the 1-2 push button.

Select HSI or ARC display by pressing either the HSI or the ARC push button.

Select the display mode (map and/or weather radar) by sequential presses of the HSI or ARC push button.

Use HEADING SELECT (SYNC or HDG) or COURSE SELECT (DIR or CRS) knobs to select the desired heading or course.

On the ED 461 with built in controls, the center push buttons on the knobs may be used to 1) rapidly acquire the DIRECT TO course to the station (DIR push button), or 2) center the heading bug under the lubber line (SYNC push button).

On the CP 468 separate control panel, the heading and course knobs may be used to 1) rapidly acquire the DIRECT TO course to the station (pull DIR knob), or 2) center the heading bug under the lubber line (pull SYNC knob).

Use the #1 and #2 BEARING POINTER SELECT push buttons to select the sensor desired by pressing the push button until the desired source is annunciated. These push buttons are also used to display independent DME information without a bearing pointer.

w ADF

After selecting ADF mode and tuning ADF #1 receiver to the desired NDB, set Bearing pointer #1 to ADF. Using CRS control, select desired course TO or FROM the NDB. The course deviation bar on the EHSI now provides left-right guidance in flying the selected course just as it would in flying a VOR course. This eliminates the mental calculations required while tracking an NDB course in the conventional manner. NDB station passage is indicated by the TO-FROM indicator and Bearing pointer reversal.

Note: ADF D-Bar presentation may not be available if the ADF does not provide a suitable flag output.

w **LNAV (RNAV)**

After selecting LNAV, NAV (KNS 81 programmed as an RNAV), GPS or RNAV mode and the desired waypoint, set Bearing Pointer #1 to the desired #1 bearing source. Using CRS knob, select desired course TO or FROM the waypoint (for the on-side LNAV only). The course deviation bar on the EHSI now provides guidance in flying the selected course. Waypoint passage is indicated by the TO-FROM indicator and waypoint BEARING pointer reversal.

Note: Wind vector and speed information is presented if supplied by ancillary equipment and only if the system was configured to display the information during installation.

Once the external LNAV system transmits to the EFS 40/50 that it is in an enroute mode, the EHSI and system sensitivity is set at 5NM left or right of course for full-scale CDI deflection.

Note: Depending on the type of LNAV installed, the Lateral Deviation Scale may be different and may support only DTK.

w **VNAV**

VNAV operation greatly depends on the type of VNAV installed. It is therefore very important to refer to the Aircraft Flight Manual Supplement and VNAV operation manual for additional information.

APPROACH PROCEDURES

w **ILS APPROACH**

On the CP 467, CP 468 or ED 461, select VOR as the Primary NAV sensor with the NAV push button. Then tune the appropriate ILS frequency. Note on the EHSI that when an ILS frequency is selected LOC replaces the VOR annunciation, the glideslope scale is displayed, and as the glide slope and localizer scales appear on the EADI the sky/ ground raster is reduced in size to provide a high-contrast background for them. Once an ILS frequency is selected, the Bearing pointer and TO-FROM indicator associated with that NAV disappears.

When DME Hold is selected on the DME control panel, DME distance is displayed in white. Groundspeed or Time-To-Station is replaced with the held VOR frequency followed by an orange H for HOLD. (DME groundspeed and VOR frequency may not be displayed in all installations.)

w **BACK COURSE APPROACH**

An option may be selected at the time of installation and certification to automatically declutter GS information when the aircraft heading is greater than + or - 105 degrees from selected ILS course. EHSI NAV MAP CDI sensing is reversed and "BC" is annunciated below the deviation scale. EADI CDI sensing is reversed and "BC" is displayed to the left of the center diamond.

Not all installations will declutter the glideslope scale. This is a display configuration option selected at the time of installation.

w **ADF APPROACH**

After selecting ADF mode and tuning ADF #1 receiver to the desired NDB, set Bearing pointer #1 to ADF. Using CRS control, select desired course TO or FROM the NDB. The course deviation bar on the EHSI now provides left-right guidance in flying the selected course as it would in flying a VOR course. This eliminates the mental calculations required while tracking an NDB course in the conventional manner. NDB station passage is indicated by the TO-FROM indicator and Bearing pointer reversal.

Note: *DF D-Bar presentation may not be available if the ADF does not provide a suitable flag output.*

w **LNAV (RNAV) APPROACH**

After selecting LNAV mode and the desired waypoint, set Bearing Pointer #1 to the desired #1 bearing sensor. If the installed LNAV supports selected course from the EFS 40/50, use the CRS knob to select desired course TO or FROM the waypoint. The course deviation bar on the EHSI now provides guidance in flying the selected course. Waypoint passage is indicated by the TO-FROM indicator and waypoint Bearing pointer reversal.

Once the external LNAV system transmits to the EFS 40/50 that it is in an approach mode, the cyan colors turn green on the EHSI and system sensitivity increases to 1.25 NM or ± 0.3 NM for GPS left or right for full-scale CDI deflection. The sensitivity becomes variable when doing a GPS approach with variable VNAV enabled for SW 15 and later. Cross-side annunciation remains yellow, but the increased sensitivity is implemented if the cross-side LNAV is in Approach Approved mode.

Note: *Depending on the type of LNAV installed, the Lateral Deviation Scale may be different and may only support DTK.*

w **VNAV GPS PRECISION APPROACH**

When the LNAV is capable of displaying precision approaches

(such as WAAS), the vertical deviation scale will appear provided valid data is being received from the LNAV and a proper approach procedure is active. Refer to the navigator pilot's guide for full scale vertical deflection operation.

w *VOR APPROACH*

After selecting NAV mode and tuning the VOR receiver to the desired frequency, set Bearing Pointer #1 to VOR #1. Using CRS control, select desired course TO or FROM the VOR station. The course deviation bar on the EHSI now provides guidance in flying the selected course. VOR passage is indicated by the TO-FROM indicator and Bearing pointer reversal.

Note that EHSI NAV information is similar to ADF except that VOR is displayed rather than ADF.

w *DECISION HEIGHT SELECTION*

Pull the DH set knob on the CP 467 or CP 470 to activate the DH set display on the EADI. Adjust the DH set knob to select the desired decision height for the particular approach. Push the DH set knob in, the select DH will be decluttered until the radar altimeter becomes valid at or below 2500 feet.

LIMITATIONS

For information on EFS 40/50 system operating limitations please refer to the approved Flight Manual Supplement for the particular aircraft in question, if one is provided.

EMERGENCY PROCEDURES

For information on EFS 40/50 system emergency procedures please refer to the approved Flight Manual Supplement for the particular aircraft in question, if one is provided.

**This page intentionally left blank.*



Figure 5.1
EHSI SELF TEST

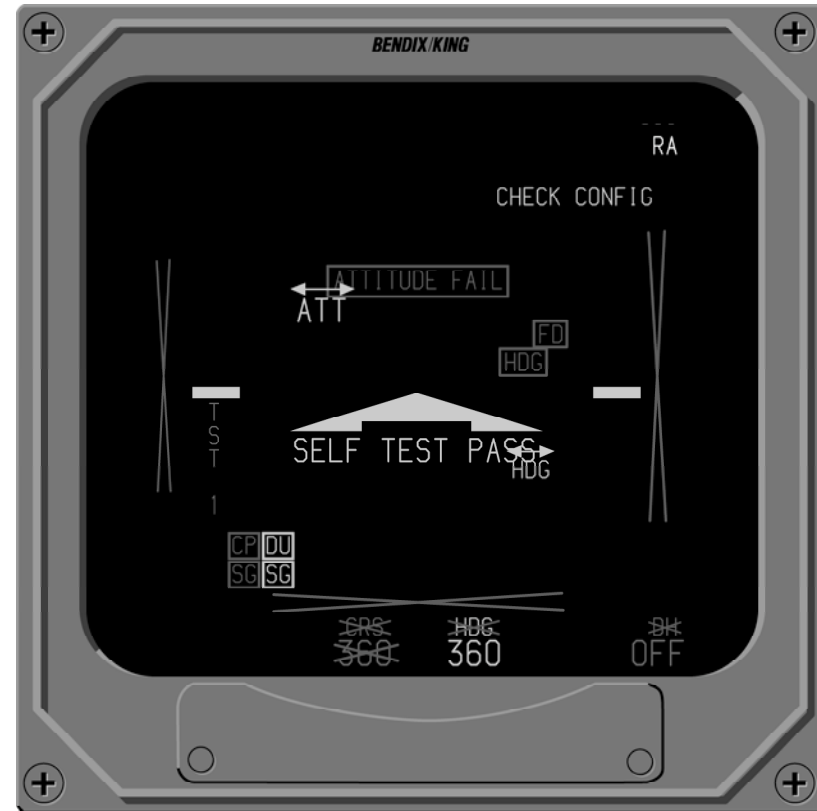

Figure 5.2
EADI SELF TEST

FAULT ANNUNCIATIONS

GENERAL

EXTERNAL SYSTEM FAILURES

w *HEADING*

Once a heading failure is detected, the EHSI lubber line and course pointer head and tail are removed. The lubber line is replaced by a RED box with a RED HDG inside it. The course deviation scale is frozen horizontally to perform the function of a conventional CDI. Selected course reference is provided by the alphanumeric CRS readout in the upper left corner. If heading was configured for display on EADI horizon line, a RED box with a RED HDG inside it will be displayed upper left of center.

During a heading failure the automatic Back Course function normally performed by the

EFS 40/50 system is inhibited. Refer to Figure 6.2 and 6.4.

w *ATTITUDE*

Once an Attitude failure is detected, the pitch scale, roll scale, roll index pointer, horizon line, heading tape, blue sky and brown ground are removed from the display. A RED box with a red "ATTITUDE FAIL" inside it is displayed on a black background in the upper center of the display.

w *FLIGHT DIRECTOR*

Once a Flight Director failure is detected a RED box with a red "FD" inside it will be displayed on the upper right side of the EADI. Refer to Figure 6.4, EADI Faults.

EFS 40/50 SYSTEM FAILURES

w *DU—DISPLAY UNIT LOSS OF COOLING*

A yellow DU enclosed in a yellow box is annunciated at the bottom left center of the EHSI or bottom left of the EADI when insufficient airflow is detected in the Display Unit. Once annunciated, the faulty Display Unit will continue to operate for at least 30 minutes if the rated ambient temperature is not exceeded. To extend the operating time, reduce display information and brightness to a minimum. Refer to Figure 6.1 and 6.4.

w *SG—SYMBOL GENERATOR LOSS OF COOLING*

A yellow SG enclosed by a yellow box is annunciated at the bottom right center of the EHSI and bottom left of the EADI if insufficient airflow is detected in the Symbol Generator. Once annunciated, the Symbol Generator will continue to operate for at least 30 minutes if the rated ambient temperature is not exceeded. To extend the operating time, reduce display information and brightness to a minimum. Refer to Figure 6.1 and 6.4.

w **CP—CONTROL PANEL** (**CP 467, CP 468, ED 461 OR** **CP 470**)

A RED CP enclosed by a RED box is annunciated left center of the EHSI and lower left of the EADI if a control panel switch becomes stuck for greater than 10 seconds. If a switch fails the display should maintain all currently selected conditions. If the switch should become functional the fault annunciation will be removed and normal operation will be restored. Refer to Figure 6.1 and 6.4.

There are two possible MFD control panel faults that can be displayed on the MFD. One fault is the normal red CP fault caused by a mode line failure. The second fault is a red CCP fault caused by a failure in the checklist control panel processing. The faults to be detected by the CP 469A to cause this annunciator include the following:

1. CPU test failure
2. ROM test failure
3. RAM test failure
4. Stuck joystick or control panel key
5. Invalid data in checklist/notes EPROM (checksum failure). This fault condition applies only if the EPROM chip is NOT completely erased. That is, if the checksum test on EPROM chip data fails because the chip is erased, a CCP fault should NOT be raised. This is because the CP469A will come from the factory with the EPROM chips erased, and it is

undesirable for the product to show a fault straight out of the box. Only if at least one of the bits in the EPROM are programmed, and the EPROM checksum test fails will a CCP fault be generated.

w **HEADING SELECT “BUG”**

A RED X will be drawn through the heading bug if there is a heading select knob failure on the EFS 40/50 control panel. Refer to Figure 6.2.

w **COURSE SELECT**

A RED X will be drawn through the course pointer head and tail if there is a course select knob failure on the EFS 40/50 control panel.

w **RCP—RADAR CONTROL** **PANEL (if equipped)**

A RED RCP enclosed by a RED box is annunciated at the lower left center of the EHSI display if a radar control panel failure is detected. Refer to Figure 6.1.

w **SG—SYMBOL GENERATOR**

A RED SG enclosed by a RED box is annunciated at the upper left center of the EHSI or lower left of the EADI if certain monitored functions are detected invalid. If the RED SG annunciation is encountered extreme caution should be used to validate any data used on the display for navigation. Even after validation and revalidation the data should

only be used as supplementary information.

A large RED "SG" appearing on a black display annunciates a Symbol Generator failure which would result in processed data that is unusable for navigation.

RAW DATA DEVIATION ANNUNCIATIONS

Pointer/Scale malfunctions are annunciated by removal of the associated pointer/scale and placing a RED X drawn in their place. A flag presented on the vertical deviation scale will result in the deviation pointer being removed. On the EHSI, the pointer/scale annunciations include lateral deviation, GS or VN and fore/aft in Doppler and homing mode. On the EADI, the scale annunciations include lateral deviation and GS or VN. Refer to figure 6.1 for display presentations showing these annunciations.

Beginning with software 09, both lateral and vertical deviation bars and scales are decluttered without displaying a RED X when the deviation information is provided in ARINC 429 format with a status of No Computed Data (NCD). The RED X is still displayed for invalid or missing data.

w BEARING POINTER ANNUNCIATIONS

Bearing pointer source failure or invalid data or No Computed Data (NCD) causes a RED X to

be drawn through the source annunciator. The bearing pointer or NAVAID symbol is also removed.

w ALPHANUMERIC READOUT ANNUNCIATIONS

Failures affecting alphanumeric readouts are annunciated by a RED X drawn through the readout. On the EHSI (figure 6.1), the alphanumeric readouts include NAV bearing pointer source and course (CRS) or desired track (DTK).

Failures affecting distance information are annunciated by RED dashes in the data field. When the Distance Source is operational but not providing valid distance data (no lock on or NCD) dashes the color of the sensor will be placed in the data field. Speed (KT) and time (MN) annunciation will be removed if valid distance, speed and time-to-station information is not provided by the primary NAV sensor system.

Failures affecting radio altimeter information are annunciated by RED dashes in the data field on the EADI. When the radio altimeter source is operational but not providing valid data (no lock on or NCD) white dashes will be placed in the data field. Refer to Figure 6.4.

w CHECK CONFIG

A yellow "CHECK CONFIG" message will display in the upper right corner of the EHSI and

Fault Annunciations

EADI whenever the system configuration memory in the symbol generator and aircraft installation rack do not match.

Test routines resident in the symbol generator select the best possible system configuration to use, however, the selected configuration may not be the intended one. Once the CHECK CONFIG message is noted, extreme caution should be exercised when using any information. It is also most important that the aircraft be taken to an authorized dealer for repair as soon as possible.

WEATHER RADAR ANNUNCIATIONS

While displaying weather, a white weather radar failure or warning annunciation can appear below the Weather Mode annunciation.

The annunciations capable of being displayed when interfaced with an RDS 81, 82/VP, 84/VP, 86/VP and RDR 2000/2100 are listed below in order of priority.

w *WX FLT*

Advises a mismatch of mode, tilt, gain or range information between the EFIS and radar RT has existed for more than 30 seconds.

w *WX OFF*

This annunciation ("OFF" before SW 08) is displayed when the radar is off.

w *BUSY VP*

Displayed when the radar is in the continuous VP mode.

w *RT FLT*

Displayed with an RDR 2000/2100 radar only to indicate an ART fault that can not be identified as a radar transmitter fault (TX FLT).

w *STB LMT*

Displayed when the combination of tilt, roll, roll trim and pitch exceeds +/- 30 degrees.

w *TGTALRT*

Beginning with EFS software version 10, "TGTALRT" is annunciated in yellow to indicate an active Target Alert. EFS with software version 09 displays this message in white. This message is only provided by the RDR 2000/2100.

w *TGT*

Beginning with EFS software version 10, "TGT" is displayed in white to indicate that the Target Alert feature is armed. This message is only provided by the RDR 2000/2100.

w *429 FLT*

Displayed when 429 control data is missing or incorrect at the radar RT. Can also indicate improper data from a 429 sensor to the RDR 2000/2100 radar.

w **ANT FLT**

Displayed when the measured antenna tilt does not match the requested tilt angle.

w **TX FLT**

Displayed when a fault is detected in the radar transmitter.

w **RANGE**

Displayed when the pilot has selected the 1000 mile range on the EFIS. The radar is unable to operate at this range and is placed in standby.

o Installation with an RDS 81, RDS 82, RDS 82VP or RDR 2000 with EFS software 07 or later, "RANGE" will annunciate when the 5 NM, 320 NM or 1000 NM range is selected.

o Installation with software 06 "WX FLT" (weather fault) will annunciate when the 5 NM or 320 NM range is selected. These annunciations alert the pilot of a range mismatch because the RDS 81, RDS 82 and RDS 82VP do not support these radar ranges.

w **STB OFF**

Displayed when stab off has been selected or when the stabilization reference is not present at the radar.

w **WAIT**

Displayed when in VP mode and one of the TRACK buttons is pressed, indicating the radar will perform the desired slicing function as soon as the antenna returns to the last selected profiling azimuth angle.

**CUSTOM DISPLAY
FAILURE ANNUNCIATIONS**

DOPPLER/CABLE

w **EXTERNAL SYSTEM
FAILURES**

FMS Warning

In the upper right hand corner of the display, a RED X will be drawn through a cyan FMS if the FMS has failed or is not supplying the EFS 40/50 with valid computed data.

Autopilot Warning

In the upper left hand corner of the display, a RED X will be drawn through a red COUPLER if the autopilot or coupler has failed or is not supplying the EFS 40/50 with valid computed data.

Note: A configuration option selectable at the time of installation and certification allows for installations of the Doppler and Cable mode without interface to an autopilot or coupler. If this option is selected the COUPLER warning will not be annunciated.

w **TCAS FAULT MESSAGES**

The TCAS ONLY display on an MFD will be replaced with up to six yellow fault messages. During this time the annunciated TCAS status will be either "TCAS FAIL" or "NO TCAS" as appropriate. Except for the status annunciation and fault messages, the display will be completely black.

The fault messages are listed in order of priority with the highest first. TCAS FAIL messages have priority over NO TCAS messages, however both can be displayed simultaneously (up to six total).

Also refer to the TCAS Status messages listed in Section 4.4.

Note: *The following is a complete list of all TCAS II faults that the EFIS will display, however some of these are not applicable to TCAS I and will not be generated by a TCAS I processor. Refer to the TCAS Pilot's Guide for more information.*

Fault Messages for TCAS Fail:

- PROCESSOR
- UPPER ANTENNA
- LOWER ANTENNA

Fault Messages for No TCAS:

- RADIO ALT 1/2
- RADIO ALT 1
- RADIO ALT 2
- XPDR 1/2
- XPDR 1
- XPDR 2
- ATTITUDE

- HEADING
- RA DISPLAY 1/2
- RA DISPLAY 1
- RA DISPLAY 2
- XPDR UPPER ANT
- XPDR LOWER ANT
- TCAS TO XPDR
- CP TO XPDR
- ALT 1/2 TO XPDR
- ALT 1 TO XPDR
- ALT 2 TO XPDR

w **LIGHTNING DETECTION DISPLAY FAULT MESSAGES**

When 429 data from the lightning sensor is missing for two seconds or remains invalid for ten seconds, the EFIS will remove the lightning cells from the display and present a fault annunciation consisting of a lightning symbol followed by the letters "FLT".



Figure 6.2
EHSI FAULT ANNUNCIATION



Figure 6.3
EHSI FAULT ANNUNCIATION



Figure 6.4
EADI FAULTS

REVERSIONARY MODES

The EFS 40/50 provides four different reversionary modes of operation in the event of a system component failure; composite, copy, display down and standby. The reversionary modes offered in a particular aircraft will vary depending on EFIS system configuration, installation wiring and certification. The following section describes the various reversionary modes offered when using the SU 463.

All external switches and placards are part of the installation supplied by the installer. For information pertaining to a particular aircraft installation refer to the approved Aircraft Flight Manual Supplement.

Note: *This Pilot's Guide refers to the left of the aircraft as the Pilot's position. The right side is considered the copilot's position.*

CMPST - COMPOSITE

Refer to Figure 7.1 ,
COMPOSITE MODE
SELECTION.

CMPST (composite) is generally
used to compensate for a failure
of a display unit or the EADI sec-

tion of the symbol generator.
Available for use in two, three,
four and five-tube installations. A
single switch input to the SG 465
instructs the symbol generator to
output the CMPST display on the
EADI and EHSI. See section 4.3
for details on the composite dis-
play.

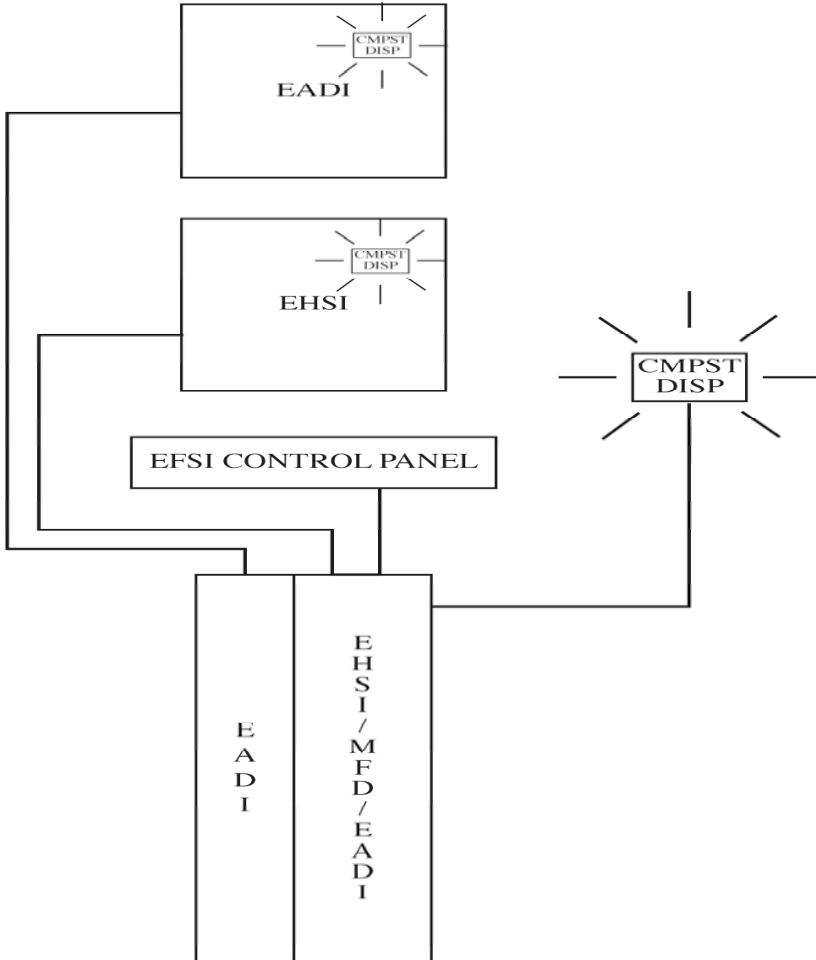

Figure 7.1
COMPOSITE MODE SELECTION

COPY OFF-SIDE

Refer to Figure 7.2
 PILOT COPY OFF-SIDE
 MODE SELECTION.

COPY OFF-SIDE is generally used to compensate for a failure of the EADI or EHSI section of the symbol generator or both. Available for use in dual EHSI and four-tube installations. The COPY mode will allow either the pilot or copilot to copy the EADI and EHSI display presentations from the off-side system. When "COPY" is requested, the OFF-

SIDE SG will provide identical copied presentation on both the pilot and copilot displays. To positively annunciate the selection of the "COPY OFF-SIDE" mode, yellow boxes will be displayed around all sensors alerting pilot and copilot they are both using the same NAV, HDG and ATT source, also "COPY" will be annunciated in the lower right corner of the EADI and EHSI display. Operational control will be retained by the side with the operating SG (the side that did not request COPY).

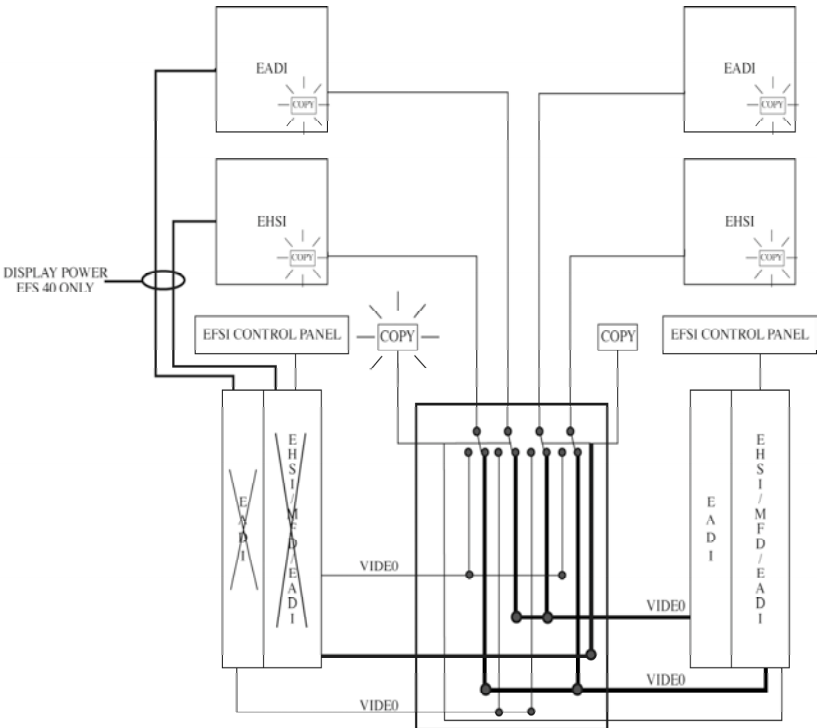

Figure 7.2
 PILOT COPY SELECTION

DISPLAY (EADI) DOWN

Refer to Figure 7.3,
EADI DOWN MODE
SELECTION.

DISPLAY (ADI) DOWN mode selection is generally used to compensate for a failure of the EADI display unit or section of the symbol generator. Available for use in two, three, four and five-tube installations. The DISPLAY DOWN mode will allow the

pilot or copilot to transfer the normal EADI display to the EHSI below the failed EADI and transfer the EHSI display to the MFD if one is installed. A single momentary switch input to the SU 463 removes power from the failed EADI, transfers the EFIS control panel control to the MFD symbol generator, instructs the EHSI symbol section to calculate EADI function and the MFD symbol generator to calculate matching EHSI functions.

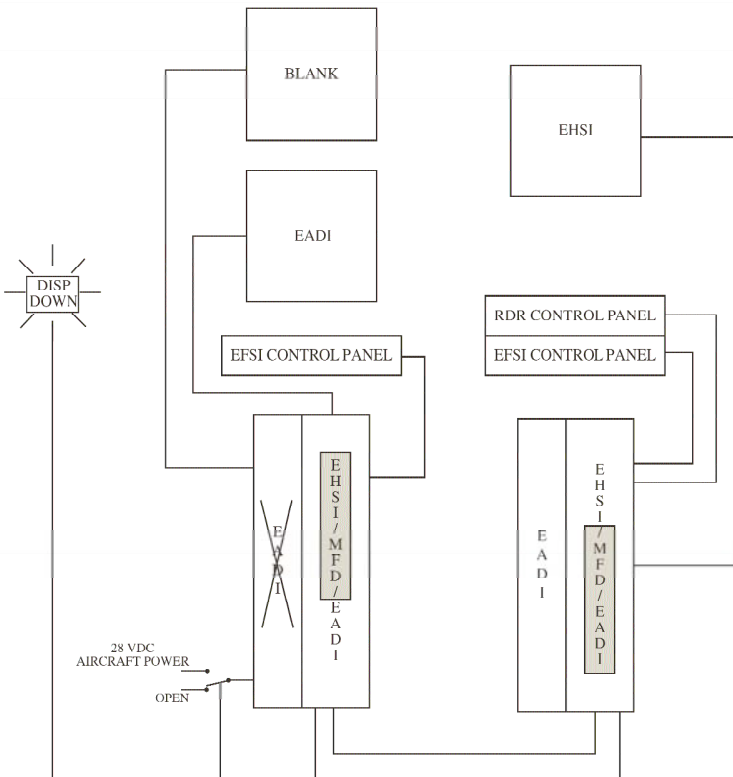

Figure 7.3
DISPLAY (EADI) DOWN MODE SELECTION

STBY - STANDBY

Refer to Figure 7.4,
PILOT STBY MODE
SELECTION.

STBY (STANDBY) mode selection is generally used to compensate for a failed pilot's or copilot's symbol generator. Available in three or five-tube installations. The STBY mode selection will allow the pilot or copilot to substitute the MFD symbol generator for his on-side symbol generator. A single momentary switch input to the SU 463 removes the failed on-side symbol generator drive

from the EADI and EHSI and transfers the MFD display drive to the on-side EADI and EHSI. Also, the MFD control panel input is removed from the MFD symbol generator as the EFIS control panel output is switched in. The MFD symbol generator is now performing normal on-side EADI and EHSI functions (inputs and outputs). To alert the pilot or copilot that the STBY mode of operation has been selected, a yellow "STBY" (SG2 or SG3 are optional in SW 06) will be annunciated in the lower right corner of the EADI and EHSI.

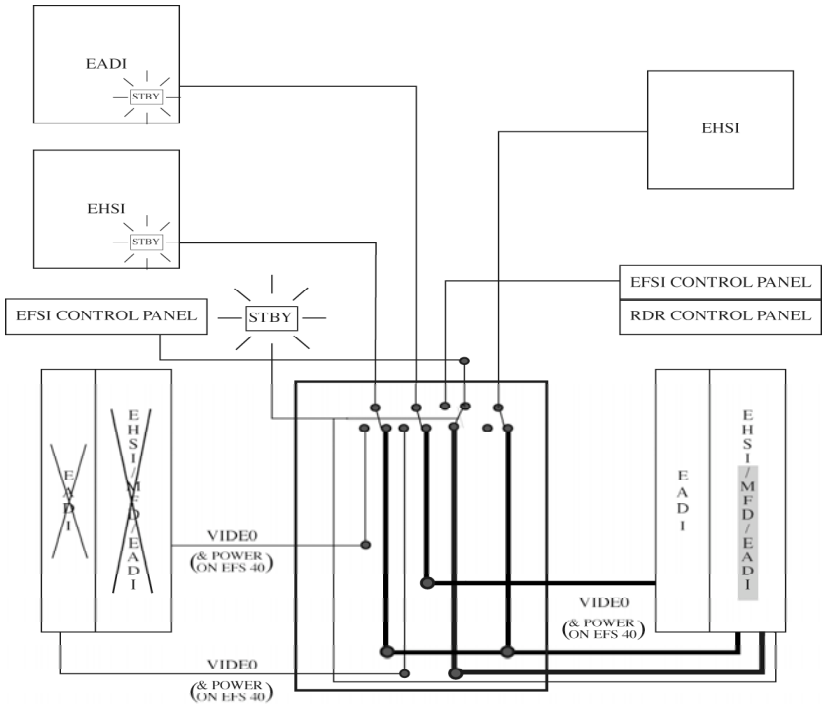

Figure 7.4
PILOT STANDBY SELECTION

REVERSIONARY MODE SELECTION

The following matrices provide information on the ability to select different reversionary modes when the SU 463 switching unit is part of the aircraft installation.

Depending on the installation and certification requirements, all reversionary modes possible may not be installed in a particular aircraft.

THREE TUBE EFS 40/50

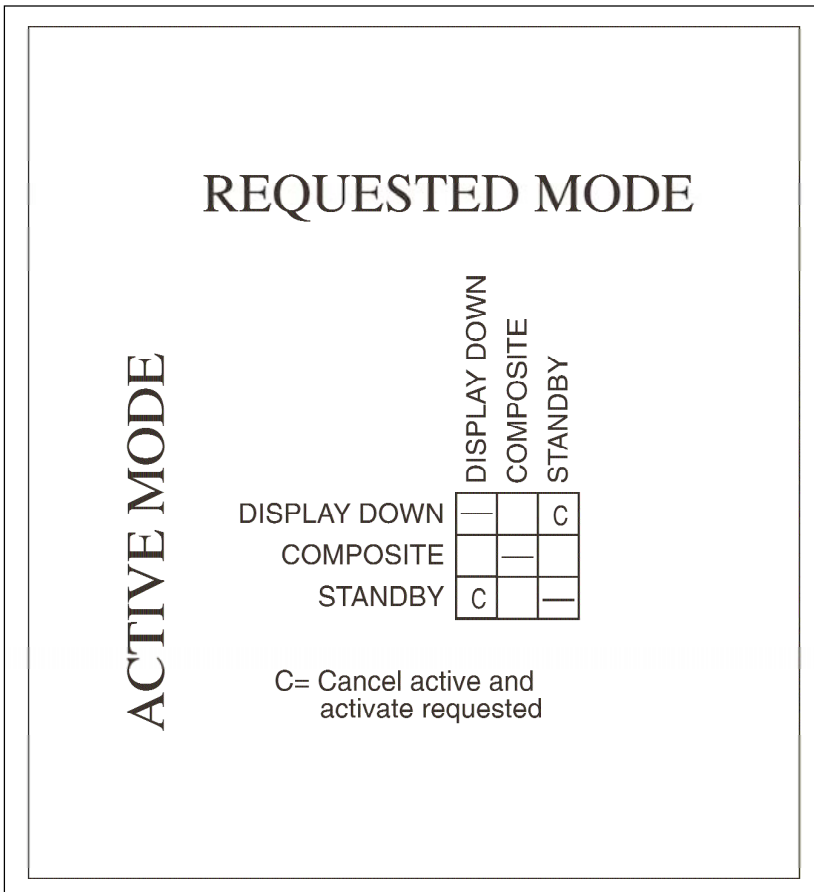

Figure 7.5
THREE TUBE EFS 40/50
REVERSIONARY MODE SELECTION

FOUR TUBE EFS 40/50

ACTIVE MODE	REQUESTED MODE						
		DISPLAY DOWN (1)	COMPOSITE (1)	COPY (1)	DISPLAY DOWN (2)	COMPOSITE (2)	COPY (2)
	DISPLAY DOWN (1)	—		C			N
	COMPOSITE (1)		—	C			
	COPY (1)	C	C	—	N		N
	DISPLAY DOWN (2)			N	—		C
	COMPOSITE (2)					—	C
COPY (2)	N		N	C	C	—	

N = Requested mode not allowed
 C = Cancel active and activate requested
 1 = Pilot
 2 = Copilot

Figure 7.6
 FOUR TUBE EFS 40/50
 REVERSIONARY MODE SELECTIONS

FIVE TUBE EFS 40

ACTIVE MODE	REQUESTED MODE					
	DISPLAY DOWN (1)	COMPOSITE (1)	STANDBY (1)	DISPLAY DOWN (2)	COMPOSITE (2)	STANDBY (2)
DISPLAY DOWN (1)	—		C			N
COMPOSITE (1)		—				
STANDBY (1)	C		—			N
DISPLAY DOWN (2)				—		C
COMPOSITE (2)					—	
STANDBY (2)			X	C		—

N = Requested mode not allowed
 C = Cancel active and activate requested
 X = If offside cancel is permitted then cancel active and activate requested.
 If offside cancel is not permitted then requested mode not allowed
 1 = Pilot
 2 = Copilot

Figure 7.7
FIVE TUBE EFS 40
REVERSIONARY MODE SELECTIONS

FIVE TUBE EFS 50

		REQUESTED MODE					
		DISPLAY DOWN (1)	COMPOSITE (1)	STANDBY(1)	DISPLAY DOWN (2)	COMPOSITE (2)	STANDBY(2)
ACTIVE MODE	DISPLAY DOWN (1)	—		C			N
	COMPOSITE (1)		—				
	STANDBY (1)	C		—			
	DISPLAY DOWN (2)				—		C
	COMPOSITE (2)					—	
	STANDBY (2)				C		—

N = Requested mode not allowed
 C = Cancel active and activate requested

In addition to the mode restriction table, the following rules apply:

If composite (2) and standby (2) are active and offside cancel is permitted and standby (1) is requested, then composite (2) is cancelled and standby (1) is activated.

If composite (2) and standby (2) are active and offside cancel is not permitted and standby (1) is requested, then standby (1) is not allowed.

If composite (2) and standby (1) are active and standby (2) is requested, then composite (2) is cancelled and standby (2) is activated.

If standby (1) and standby (2) are active and composite (2) is requested, then composite (2) is not activated.

Figure 7.8
FIVE TUBE EFS 50
REVERSIONARY MODE SELECTIONS

Note: EFS 50 installations will support dual STBY, allowing the pilot and copilot to select STBY at the same time. EFS 40 will not support dual standby.

** This page intentionally left blank.*

GLOSSARY

ABBREVIATIONS

ABV	Above
ADF	Automatic Direction Finder
ADS	Air Data System
ADI	Attitude Director Indicator
AHRS	Attitude Heading Reference System
AHS	Attitude Heading System
ANG	Angle
ANT	Antenna
ARINC	Aeronautical Radio INCorporated
ATR	Air Transport Radio
ATT	Attitude
AZ	Azimuth
BAZ	Back Azimuth
BC	Back Course
BLW	Below
BRG	Bearing
BRT	Bright
CCP`	Checklist Control Panel
CDI	Course Deviation Indicator or Course Deviation Information
CDU	Control Display Unit
CONFIG	Configuration
CP	Control Panel
CRS	Course
CRT	Cathode Ray Tube
D-BAR	Deviation Bar
DEG	Degree(s)
DEV	Deviation
DG	Directional Gyro
DIR	Direct
DME	Distance Measuring Equipment
DTK	Desired Track
DU	Display Unit
EADI	Electronic Attitude Direction Indicator
ED	Electronic Display
EFS or EFIS	Electronic Flight Instrument System
EGPWS	Enhanced Ground Proximity Warning System
EHSI	Electronic Horizontal Situation Indicator
FHDG	Free Directional Gyro (heading)
FL	Flight Level (Pressure altitude)
FLT	Fault
FMS	Flight Management System

Glossary

FPL	Flight Plan
FR	From
FT	Feet
GP	Glidepath (used with MLS and GPS approach)
GPS	Global Positioning System
GS	Ground Speed or Glideslope
HDG	Heading
HSI	Horizontal Situation Indicator
ICAO	International Civil Aviation Organization
ID	Identification
ILS	Instrument Landing System
KTS	Knots (nautical miles per hour)
LMT	Limit
LNAV	Long-range NAVigation
LOR	Loran
MLS	Microwave Landing System
NAV	Navigation
NM	Nautical Mile
RA	Resolution Advisory
RCP	Radar Control Panel
REF	Reference
RMI	Radio Magnetic Indicator
RNAV	Area NAVigation
SG	Symbol Generator
SN	Sensitivity
STB	Stabilization
STBY	Standby
SW	Software
SYNC	Synchronization
TA	Traffic Advisory
TACAN	Tactical Air Navigation
TCAS	Traffic alert and Collision Avoidance System
TCN	TACAN, Tactical Air Navigation
TD	Traffic Display
TST	Test
TTS	Time-To-Station
TTW	Time-to-Waypoint
TX	Transmitter
VNAV	Vertical Navigation
VN	Vertical Navigation Scale
VOR	VHF Omni Range
VORTAC	VOR and TACAN co-located
VP	Vertical Profile
WX	Weather
WXA	Weather Alert

INDEX**A**

ADF	
ADF 1	1.6, 1.9, 1.12, 1.15, 1.18, 2.1, 2.3, 2.6, 5.2, 5.4
ADF 2	1.6, 1.9, 1.12, 1.15, 1.18, 2.1.6
ALPHANUMERIC READOUT ANNUNCIATIONS.....	6.3
AN	i.1, 1.1, 1.3, 2.1.4-10, 2.2.1-2, 2.3.1, 2.3.4, 2.4.1-6, 4.1.1,4.1.3-21, 4.1.23-25, 4.2.1-5, 4.2.7-12, 4.2.15, 4.3.1-3,4.4.1-3, 4.4.6-9, 4.4.11, 4.4.13, 4.4.15, 5.2-4, 6.1, 6.4-5, 8.1
ANT FLT	6.4
APPROACH PROCEDURES	5.3
ARC	
ARC NAV MAP	2.1.7
ARC SECTORED MODE SELECTION:	2.1.7
ATT.....	1.8, 1.11, 1.14, 1.17, 1.20, 4.2.12-13, 4.2.15, 7.3, 8.1
ATTITUDE	1.6, 1.9, 1.12, 1.15, 1.18, 4.1.1, 4.2.1-2,4.2.7, 4.2.11, 4.2.13, 4.2.15-16, 6.1, 6.5, 8.1
AUTO TILT	2.3.4, 4.1.18
AUTOPILOT WARNING	6.5

B

BACK COURSE	
BACK COURSE APPROACH.....	5.3
BC.....	1.7, 1.10, 1.13, 1.16, 1.19, 4.1.15, 4.2.8, 5.3-4, 8.1
BEARING	
#1 BEARING POINTER.....	4.1.9
#2 BEARING POINTER.....	4.1.9, 5.2
1-2 PUSH BUTTON.....	2.4.3, 4.1.2-3, 5.2
BEARING POINTER	2.1.6, 4.1.6-11, 4.1.15-16, 4.1.20, 5.2-4, 6.3
BEARING POINTER ANNUNCIATIONS	6.3
BEARING POINTER SELECT	2.1.6, 5.2
BRT KNOB	2.1.10, 2.2.2
BUSY VP	6.4

C

CATEGORY I4.2.12-14

CHECK CONFIG.....6.3-4

CHECKLIST

 CHECKLIST INTERFACE4.4.3

COMMAND BARS.....1.8, 1.11, 1.14, 1.17, 1.20, 4.2.2-3, 4.2.11, 4.2.13

COMPASS CARD4.1.1, 4.1.4, 4.1.9-11, 4.1.14, 4.1.16,
.....4.1.18, 4.1.22-25, 4.3.2, 4.4.1

COMPOSITE4.2.10-11, 4.2.13, 4.3.1-4, 7.1-2

COPY4.2.13, 7.1, 7.3

COOLING6.1

COURSE DEVIATION INDICATOR4.1.15, 4.1.21, 8.1

COURSE SELECT

 COURSE SELECT KNOB2.1.10, 2.4.2, 4.1.4-5, 4.4.1, 6.2

 CRS1.11, 1.14, 1.17, 1.20, 2.4.2, 4.1.3-5, 4.3.1-2,
.....4.4.1, 4.4.7, 4.4.10, 5.2-4, 6.1, 6.3, 8.1

 CRS KNOB2.4.2, 4.1.5, 4.4.1, 4.4.10, 5.3-4

CONTROL PANELS2.1.1, 2.3.1, 2.4.2, 4.1.19

CP 466Ai.1, 2.1.1, 2.3.1, 4, 2.4.1

CP 466Bi.1, 2.3.1, 2.3.4

CP 468i.1, 2.1.1-2, 2.1.10, 2.4.2-3, 2.4.6, 3.2, 5.1-3, 6.2

CP 469A.....i.1, 1.2, 2.4.1, 2.4.4, 3.5, 4.4.3-4, 4.4.6-8, 4.4.10-11, 6.2

D

DETAILED OPERATING CONTROLS.....2.1.1, 2.2.1

DG1.7, 1.10, 1.13, 1.16, 1.19, 2.1.5, 2.4.5, 4.1.1-2, 8.1

DIRECT TO1.2, 2.1.10, 5.2

DISPLAY BRIGHTNESS CONTROL2.1.10, 2.2.2

DISTANCE, GROUND SPEED AND TIME-TO-STATION4.1.6

DME.....

 DME HOLD.....4.1.6-9, 4.3.1, 4.3.3, 5.3

DOPPLER

 DOPP2.1.4, 4.1.22

 DOPPLER VELOCITY BARS4.1.22

DRIFT ANGLE POINTER	4.1.3, 4.1.13
DTK	2.4.2, 4.1.4-5, 5.3-4, 6.3, 8.1
DU-DISPLAY UNIT LOSS OF COOLING	6.1

E

EGPWS	4.4.16
EMERGENCY PROCEDURES	4.4.4, 5.5
EXTERNAL SYSTEM FAILURES	6.1, 6.5

F

FAULT ANNUNCIATIONS	4.4.10, 6.1-6
FR	4.1.15, 4.3.1, 4.3.3, 8.2
FREE DG	4.1.1
FROM	1.5-6, 2.1.3, 2.2.2, 2.3.4, 2.4.2, 2.4.4-5, 4.1.5-11, 4.1.13-17,4.1.19, 4.1.21-26, 4.2.1-2, 4.2.6-7, 4.2.11-12, 4.3.1-3,4.4.1-4, 4.4.6, 4.4.8-10, 4.4.13, 5.2-4, 6.1-2, 7.3-5, 8.2
FT	4.1.12, 4.2.7, 4.2.14-15, 8.2
FULL TIME LNAV MAP	4.1.19-20

G

GAIN	2.3.3-4, 4.1.18, 6.4
GLIDESLOPE	
GS	1.7, 1.10, 1.13, 1.16, 1.19, 4.1.7, 4.1.11-12,4.2.4, 4.2.9, 4.2.11, 4.2.14-15, 5.3, 6.3, 8.2
GND MAP	2.3.2-4

H

HEADING SELECT	
HEADING BUG	
HDG BUG	4.1.21
HEADING SELECT "BUG"	4.1.4, 6.2
HEADING SELECT KNOB	2.1.10, 4.1.4, 6.2
HEADING SYNC	2.1.10
HOMING	
HOM	4.1.25

Index

HSI1.6, 2.1.4-5, 2.1.7, 2.4.2, 2.4.4, 4.1.16,
.....4.2.8, 4.2.12-13, 4.4.9, 5.2, 8.2

I

ILS
 ILS APPROACH4.1.5, 5.3
IN-FLIGHT OPERATION5.2

K

KNS 812.1.4, 2.4.3-5, 4.1.3, 4.1.14, 4.1.16, 5.3

L

LATERAL COURSE
 LATERAL COURSE DEVIATION BAR4.1.6, 4.3.2
 LATERAL COURSE DEVIATION SCALE4.1.5, 4.3.2
LIGHTNING
 LIGHTNING DETECTION2.1.5, 4.1.19
LIMITATIONS5.1, 5.5
LNAV
 LNAV MAP2.1.9, 2.4.1, 4.1.19-20
LOC4.1.15, 4.2.7-8, 4.2.15, 5.3
LOR2.1.3, 2.1.5, 4.1.10, 4.1.13, 8.2

M

MAGNETIC
 MAG4.1.9-11
 MAG VAR4.1.9-11
MAP
 360 MAP DISPLAYS4.1.14
 360 NAV MAP2.1.7
 360 DEGREE MAP WX RADAR4.1.17
 MAP 360 COMPASS CARD4.1.14
 MAP COURSE DEVIATION INDICATOR4.1.15
 NO MAP4.1.15, 4.1.19
MEMORY2.1.3, 4.1.23, 4.4.4-6, 6.3
MFDi.1, 1.2-3, 1.9-10, 1.12-13, 1.15-16, 1.18-19, 2.1.5, 2.1.7-8, 2.3.4,
.....2.4.1-6, 3.4-5, 4.1.7, 4.1.17, 4.1.19, 4.4.1-16, 5.1, 6.2, 6.5, 7.4-5

MULTI FUNCTION DISPLAY	2.1.7, 2.4.1, 4.4.1
MLS...1.6, 1.9, 1.12, 1.15, 1.18, 1.20, 4.1.4, 4.1.6-8, 4.1.11-12, 4.2.7-10,	4.2.12-13, 4.2.15, 4.3.2-3, 8.2
MODE	
1-2.....	2.1.3, 2.1.5, 2.4.3, 4.1.2-3, 4.4.7, 4.4.9, 5.2
360-DEGREE MODE	2.1.7

N

NAV	
1-2 NAVIGATION SYSTEM SELECT	2.1.3
NAV CDI MAP	2.1.7
NAV MAP	2.1.5, 2.1.7-9, 2.4.4, 4.1.4, 4.1.16-17, 4.4.3, 5.3
NAV NAVIGATION SENSOR SELECT	2.1.3
NAVIGATION SOURCE ANNUNCIATION	4.1.2, 4.3.2
NDB	2.1.5, 4.1.11, 5.2, 5.4

O

OFF	2.2.2, 2.3.2, 2.3.4, 2.4.3-4, 4.1.11, 4.1.14, 4.1.16-17, 4.1.19-20,	4.2.3, 4.2.7, 4.4.2, 4.4.4-5, 4.4.7-9, 5.1, 6.4-5, 7.3		
OFF-STBY-TST-ON	2.3.2			
OMG	2.1.3, 2.1.5, 4.1.10, 4.1.13, 8.2			
ON	i.1-2, 1.2, 1.2, 1.7, 1.9-10, 1.12-13, 1.15-16, 1.18-19, 2.1.2-8,	2.1.10, 2.2.1-2, 2.3.1-4, 2.4.1-6, 4.1.2-5, 4.1.7, 4.1.10-22,	4.1.24, 4.1.26, 4.2.2, 4.2.5-16, 4.3.1-3, 4.4.1-13, 4.4.15-16,	5.1-5, 6.1-5, 7.1-3, 7.6
OPERATING INSTRUCTIONS	2.1.2, 2.2.1, 5.1-6			

P

PITCH.....	4.2.1-3, 4.2.5, 4.2.7, 4.2.15, 4.3.1, 6.1, 6.4
PLAN VIEW	2.1.5, 2.4.2, 2.4.4-5
PRE-TAKEOFF PROCEDURES	5.1
PRE-FLIGHT PROCEDURES	5.1
PULL ARL.....	2.3.4
PULL AUTO.....	2.3.4
PULL STAB OFF	2.3.4
PUSH BUTTON TEST.....	5.1

R

RADAR
 RADAR CONTROLS2.1.8, 2.3.1
 RCP-RADAR CONTROL PANEL6.2
 RDR 14004.1.17, 4.4.15
 TARGET ALERT4.1.19, 6.4
RADIO ALTIMETER1.2, 2.2.2, 4.2.6-9, 4.2.13, 6.3
RANGE
 RANGE DOWN2.1.8, 4.4.9
 RANGE RING2.4.4, 4.1.14, 4.1.16-17, 4.4.1-2, 4.4.12
 RANGE SELECTION2.1.8, 4.1.17-19, 4.4.12
 RANGE UP2.1.8, 2.4.3, 4.4.9
RAW DATA DEVIATION ANNUNCIATIONS6.3
REF
 REF MAP FORMAT2.1.9
REVERSIONARY MODE4.1.7, 4.2.11, 4.2.15, 7.6-9
RISING RUNWAY1.14, 1.17, 1.20, 4.2.7-9, 4.2.13-14
RNAV
 RNV4.1.10
ROLL1.8, 1.11, 1.14, 1.17, 1.20, 4.2.1-3,
.....4.2.5, 4.2.11, 4.2.15, 4.3.1, 6.1, 6.4

S

SELECTED COURSE2.1.3, 2.1.10, 2.4.2, 4.1.4-6, 4.1.12-15,
.....4.1.25, 4.2.8-9, 4.3.1-2, 4.4.1, 5.2-4, 6.1
SELF TEST2.1.8, 2.2.2, 5.1
SN4.1.26, 8.2
SOFTWARE
 SOFTWARE 04i.1, 1.6, 2.1.4, 2.1.8, 2.4.6, 4.1.6, 4.1.22, 4.1.24
 SOFTWARE 051.9, 4.1.19, 4.1.25
 SOFTWARE 061.12, 2.1.5, 4.1.4, 4.1.12, 6.4
 SOFTWARE 071.15, 2.4.2, 4.1.7, 4.1.13, 4.2.12, 4.4.2, 6.4
 SOFTWARE 08i.1, 1.18, 2.1.3-5, 2.1.8-9, 4.1.3, 4.1.6-7,
.....4.1.12, 4.2.9-10, 4.4.3, 4.4.11
STAB OFF2.3.4, 6.5
STANDARD EHSI DISPLAYS4.1.1, 4.1.16, 4.1.22-24

START UP	5.1
STB LMT	6.4
STB OFF	6.5
STBY	2.3.2, 4.1.17, 4.4.14, 7.5, 7.9, 8.2
SYMBOL	
SG-SYMBOL GENERATOR	6.2
SG-SYMBOL GENERATOR LOSS OF COOLING	6.1
SYMBOLIC AIRCRAFT	4.1.3, 4.1.5, 4.1.10, 4.1.17-18, 4.1.22-24, 4.1.26, 4.2.2-3, 4.3.1, 4.4.1-2, 4.4.12
SYSTEM CONFIGURATION	1.1-20, 4.1.3, 6.3-4, 7.1

T

TCAS	
TCAS INTERFACE	
TCAS SELECTION	2.4.6
TCAS DISPLAY FORMAT	4.4.12
TCAS TRAFFIC SYMBOLOGY	4.4.12
TCAS DISPLAY ANNUNCIATIONS	4.4.13
TCN	2.1.3, 4.1.3, 4.1.10, 8.2
TENDENCY CIRCLE	4.1.23, 4.1.25
THRUST COMMAND	4.1.25
TILT	2.3.4, 4.1.17-18, 6.4
TO	i.1-2, 1.1-3, 1.5-6, 1.9, 1.12, 1.15, 1.18, 2.1.2-10, 2.2.1-2, 2.3.1-4, 2.4.1-6, 4.1.1-26, 4.2.1-13, 4.2.15-16, 4.3.1-3, 4.4.1-15, 5.1-5, 6.1-5, 7.1-6, 7.9
TO-FROM	5.2-4
TRUE	2.4.4, 4.1.9, 4.1.11, 4.1.16, 4.2.13, 4.2.16, 4.4.2
TST	2.1.8-9, 2.2.2, 2.3.2, 4.4.10-11, 5.1, 8.2
TST/REF	
SELF TEST	2.1.8, 2.2.2, 5.1
TX FLT	6.4

V

VELOCITY AND TARGET SCALE	4.1.22
VN	4.1.12, 4.2.9, 6.3

Index

VNAV1.7, 1.10, 1.13, 1.16, 1.19-20, 4.1.11-12, 4.2.4, 4.2.9, 5.3, 8.2
 VNAV GPS PRECISION APPROACH.....5.4
VOR.....
 VOR APPROACH5.5
VERTICAL PROFILE.....
 VP.....2.3.1, 2.3.3-4, 4.4.1-2, 6.4-5, 8.2

W

WAIT2.3.3, 6.5
WEATHER.....
 WEATHER RADAR ANNUNCIATIONS.....6.4
WX.....2.3.2-3, 4.1.17-18, 6.4, 8.2
WX FLT.....4.1.18, 6.4
WXA.....2.3.2-3, 4.1.18, 8.2
WIND VECTOR
 WIND VECTOR INFORMATION4.1.13, 4.1.23-24

Honeywell International Inc.
One Technology Center
23500 West 105th Street
Olathe, Kansas 66061
FAX 913-791-1302
Telephone: (913) 712-0400

Copyright © 1996,2005, 2008, 2010 Honeywell International Inc.
All rights reserved.

006-08701-0000 8/10
SW 04/05/06/07/08/09/10/11/12/13/14/15/16

Honeywell