



Appendix F

Vizion PMA Autopilot C182E-C182T Installation

Make	TCDS	Models
Cessna Aircraft Company	A42EU	F182P, F182Q, FR182
Textron Aviation, Inc.	3A13	182E, 182F, 182G, 182H, 182J, 182K, 182L, 182M, 182N, 182P, 182Q, 182R, 182S, 182T, R182,T182, TR182, T182T

RESTRICTION ON USE, DUPLICATION, OR DISCLOSURE OF PROPRIETARY INFORMATION

THIS DOCUMENT CONTAINS PROPRIETARY INFORMATION OF TRUTRAK FLIGHT SYSTEMS, INC. AND MAY NOT BE REPRODUCED, COPIED, DISCLOSED OR UTILIZED IN ANY WAY, IN WHOLE OR IN PART, WITHOUT THE PRIOR WRITTEN CONSENT OF TRUTRAK FLIGHT SYSTEMS, INC.

Prepared by

TruTrak Flight Systems, Inc.

	Function/Title	Name
Prepared by	Engineering	Zach Williamson
Prepared by	President	Andrew Barker
Checked by	GM	Moss Foster
Approved by	President	Andrew Barker



Table of Contents

1. Document Revision History	3
2. Cessna 182E-182T Controller / Wiring Harness Installation	4
2.1. Wiring Harness Materials List.....	4
2.2. Wiring Harness / Controller Mounting Instructions.....	5
3. Cessna 182E-182T Servo Installation.....	11
3.1. Roll Servo Materials List.....	11
3.2. Cessna 182E-182T Roll Servo Mounting Instructions.....	12
3.3. Pitch Servo Materials List.....	21
3.4. Cessna 182E-182T Pitch Servo Mounting Instructions.....	22
3.5. Cessna 182E-182T Vizion Roll IPC.....	28
3.6. Cessna 182E-182T Vizion Pitch IPC.....	29
4. Cessna 182E-182T Autopilot Settings	30
4.1. Lateral Autopilot Settings.....	30
4.2. Vertical Autopilot Settings.....	31



1. Document Revision History

Rev	Description	Pages	Date
IR	Initial Release	30	8-16-18
A	Added BK part numbers, made changes for PV.40 software, made revisions to roll install for P model on.	33	6-5-19

2. Cessna 182E-182T Controller / Wiring Harness Installation

2.1. Wiring Harness Materials List

Qty	Description	Part Number
1	Vizion Wiring Harness 30'	8220-033
1	Vizion 2" Controller OR Vizion 3" Controller OR Vizion Flat Pack Controller	8000-174 or 8000-183 OR 8000-176 or 8000-184 OR 8000-175 or 8000-185
100	MS3367-1-0 Cable Tie	
2	Connector D-sub Female 9 Pin Crimp	2100-044
16	Female Socket Crimp Connector D-sub	2100-045
2	Connector Backshell 9 Pin	2100-010
1	Vizion Emergency Level Button Kit	8100-113
1	Vizion Limitations Placard	8300-092
1	5A AP circuit breaker (not supplied)	
1	Control Wheel Steering Switch (not supplied, but MUST be RED in color)	
1	AP Master Switch (not supplied)	
4	6-32 X 3/8" Instrument mounting screw (not supplied)	
N/A	Various terminals and pins for connection of power and GPS	
N/A	1/8"-27 NPT male fittings and tees for connecting the A/P pitot and static to the aircraft systems	

2.2. Wiring Harness / Controller Mounting Instructions

1. Begin by disconnecting the aircraft battery.
2. Select a mounting location for the autopilot controller.
 - 2.1. Consider the overall mounting depth of the controller with pitot, static, and electrical connections and allow clearance where necessary, especially surrounding the moving yoke assembly.
 - 2.2. Ensure that mounting location does not require autopilot servo lines to run near com antenna coax.
 - 2.3. Ensure that there is sufficient space near the autopilot controller to install the Vizion Limitations Placard (Trutrak P/N 8300-092)
3. Remove the instrument panel and panel overlays as necessary.
4. Remove the seats.
5. Remove the left A-pillar and kick panel trim.
6. Remove carpeting.
7. Wiring harness routing.
 - 7.1. Route the pitch (white) and roll (black) servo harnesses from the controller to the left side of the panel.
 - 7.2. Route the roll (black) servo harness up the left A pillar and out the leading edge of the left wing as shown in Figure 2-1, Figure 2-2, and Figure 2-3. Extend the excess harness out the inspection hole just forward of the

inboard end of the left aileron. The excess length will be trimmed and the harness terminated when the roll servo is installed.



Figure 2-1



Figure 2-2

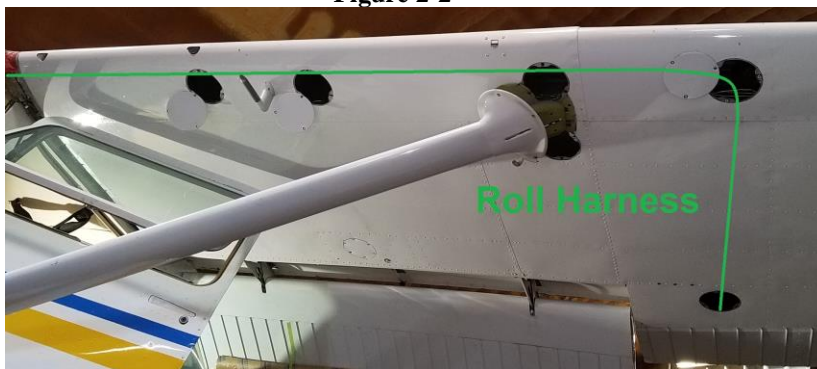

Figure 2-3

7.3. Route the pitch (white) servo harness down the left kick panel and under the floor. Continue running the harness to the pitch servo mounting location as shown in Figure 2-4 and Figure 2-5. The excess length will be trimmed and the harness terminated when the pitch servo is in place.



Figure 2-4

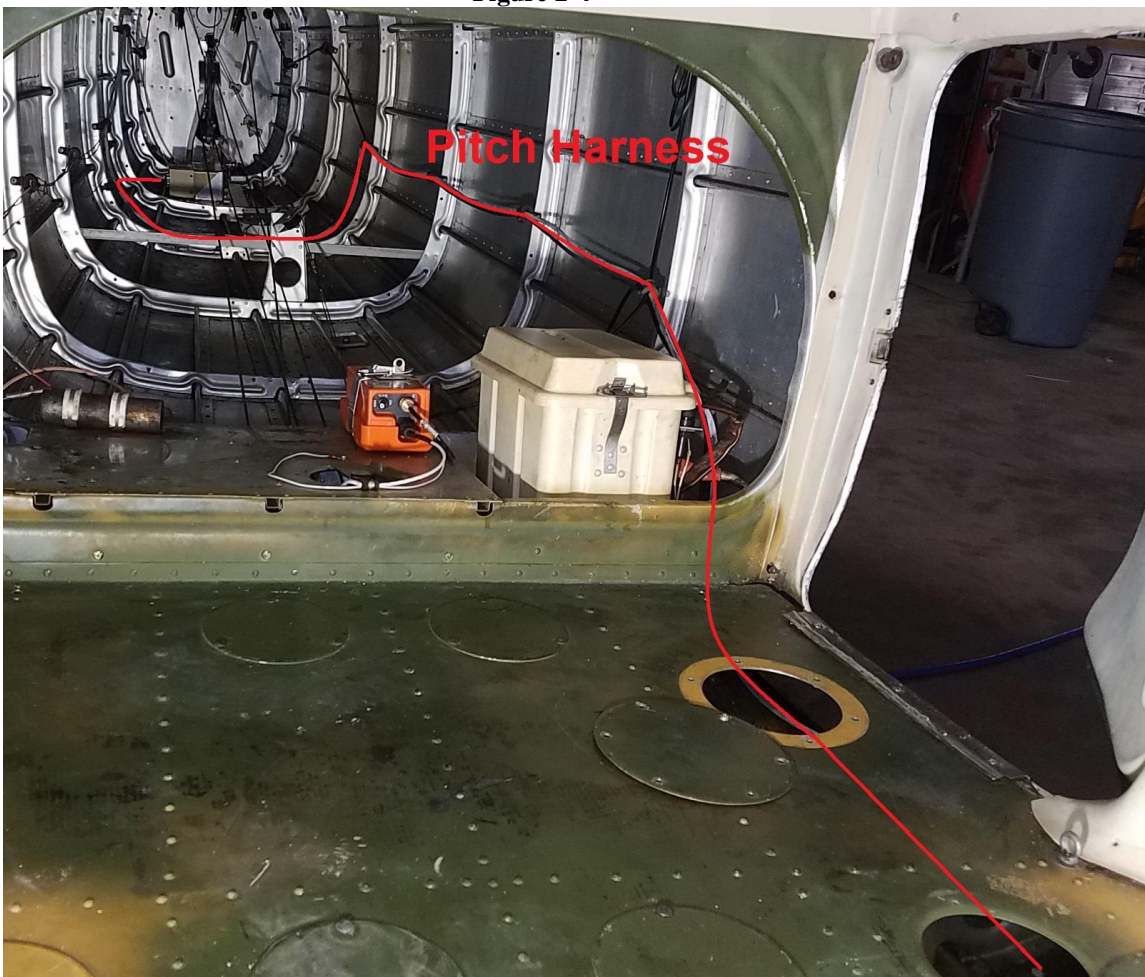

Figure 2-5

8. Select appropriate mounting locations for the AP Master, AP Circuit Breaker, Emergency Level and control wheel steering switches. Connect these items per the Vizion wiring diagram in the Vizion PMA Installation Guide (TruTrak Doc. 166).
 - 8.1. **All items in this step are required to be installed. The AP Master Switch, AP Circuit Breaker, and Control Wheel Steering switches must be labeled. The Control Wheel Steering Switch must be RED.**



9. Connect GPS inputs per the Vizion wiring diagram in Vizion PMA Installation Guide (TruTrak Doc. 166)

10. Conduct pitot / static check of aircraft system before opening any pitot/ static connections!

11. Mount autopilot controller in panel using 4 6-32 X 3/8" screws. Connect wiring harness and connect pitot and static per Vizion PMA Installation Guide (TruTrak Doc. 166).

12. Install Vizion Limitations Placard (Trutrak P/N 8300-092) near the Vizion autopilot. A sample panel with potential placard location is shown below:

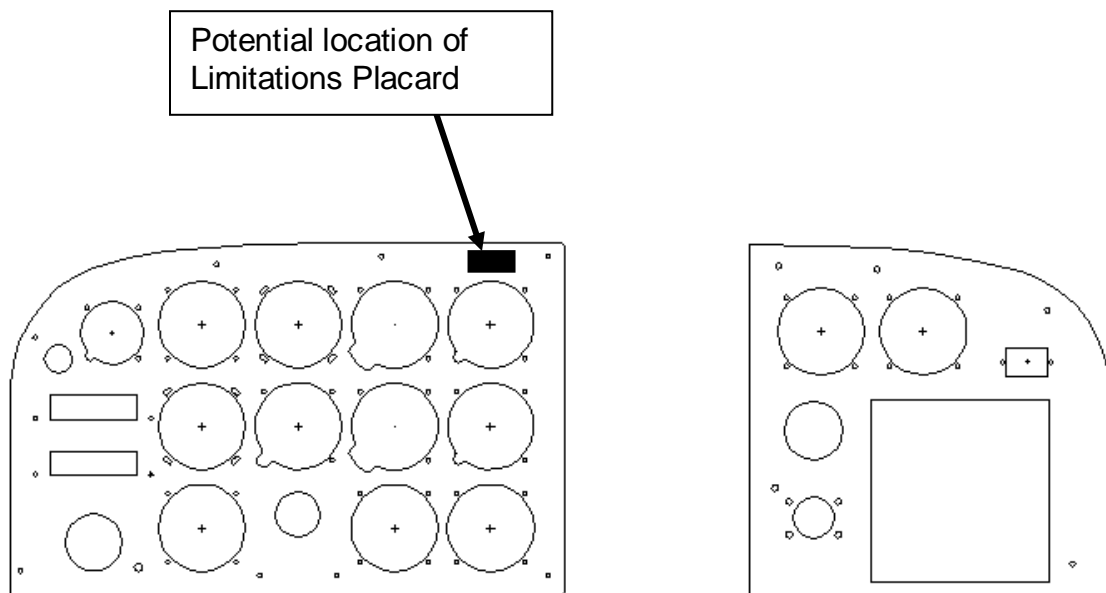

13. Reinstall the instrument panel and panel overlays.
14. Reinstall interior trim.
15. Reinstall carpeting.
16. Reinstall seats.
17. Reconnect battery.
18. Once autopilot settings are confirmed, perform autopilot system test per the Vizion PMA Installation Guide (TruTrak Doc. 166).

3. Cessna 182E-182T Servo Installation

3.1. Roll Servo Materials List

QTY	PART NUMBER	DESCRIPTION
1	8100-064 (12 Volt) 8100-065 (24 Volt)	60 in-lb PMA Servo
1	7200-091	C172 Roll Servo Arm
1	2520-062	41" Push Rod .5" OD Tapped 10-32
12	2510-192	Rivet MS20426A3-4
1	2510-073	.250 L X .375 OD X .199 ID Aluminum Spacer
2	2510-051	Small Rod End Bearing MM-3-300
3	2500-216	8-32 x 3/8 Flat Head Socket Cap Screw SS
6	2500-122	MS21051-08 8-32 Anchor Nut
1	2500-120	AN3-14A
4	2500-081	MS35333-39 Internal Lock Washer
3	2500-076	AN960-10
4	2500-075	AN3-3A
1	2500-071	AN3-10A
6	2500-069	8-32 X 5/8 Screw AN526C832R10
1	2500-068	AN3-7A
2	2500-055	AN345-10
2	2500-047	AN970-3 Washer
2	2500-042	MS20364-1032
1	1450-128	18X Lower Roll Bracket
1	1450-127	18X Upper Roll Bracket
1	1420-216	Servo Bolt Pattern Plate
1	1420-209	1.5" PMA Servo Arm

3.2. Cessna 182E-182T Roll Servo Mounting Instructions

NOTE: Apply torque seal to all bolts after final torquing is achieved.

1. The roll servo will be mounted in the left wing just forward of the inboard end of the aileron.
 - 1.1. Begin by removing the inspection cover on the lower wing skin located forward of the inboard end of the aileron.
 - 1.2. Figure 3-1 shows the roll servo mounting location from below the left wing.

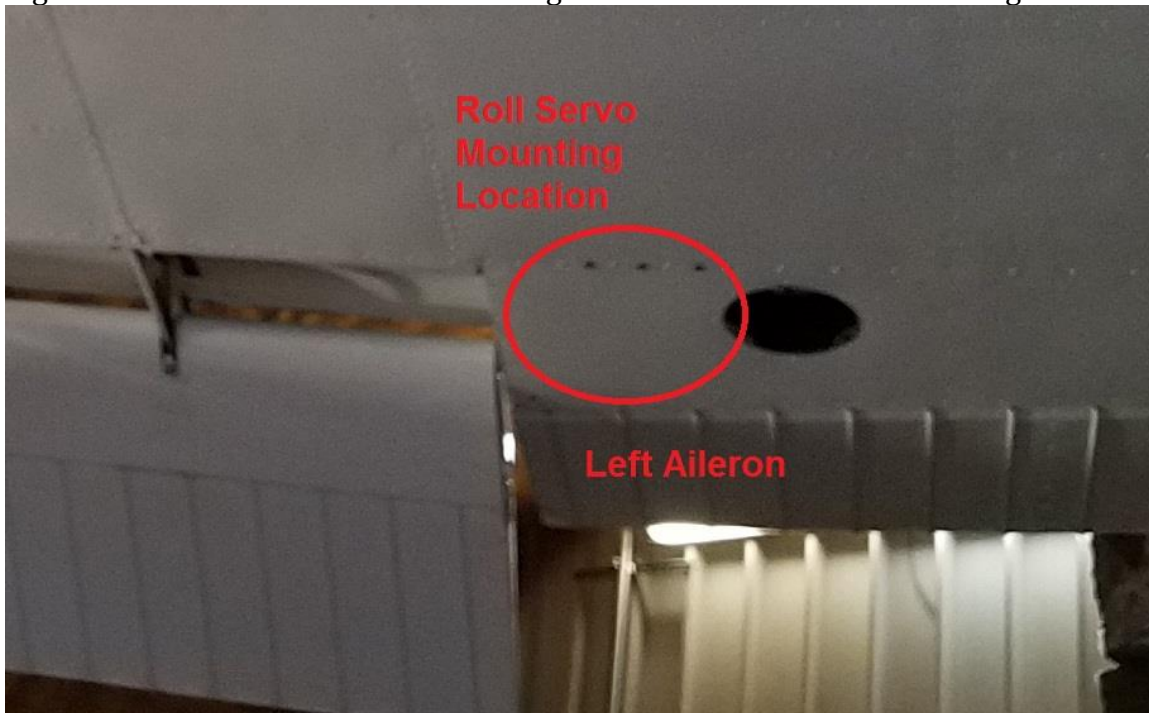

Figure 3-1

2. The Cessna 18X Upper Roll Bracket (P/N 1450-127) will be mounted to the flange of the rear wing spar using 3 ea. AN526C-832R8 screws.
 - 2.1. Locate the inboard screw hole as shown in Figure 3-2 on the upper wing skin.

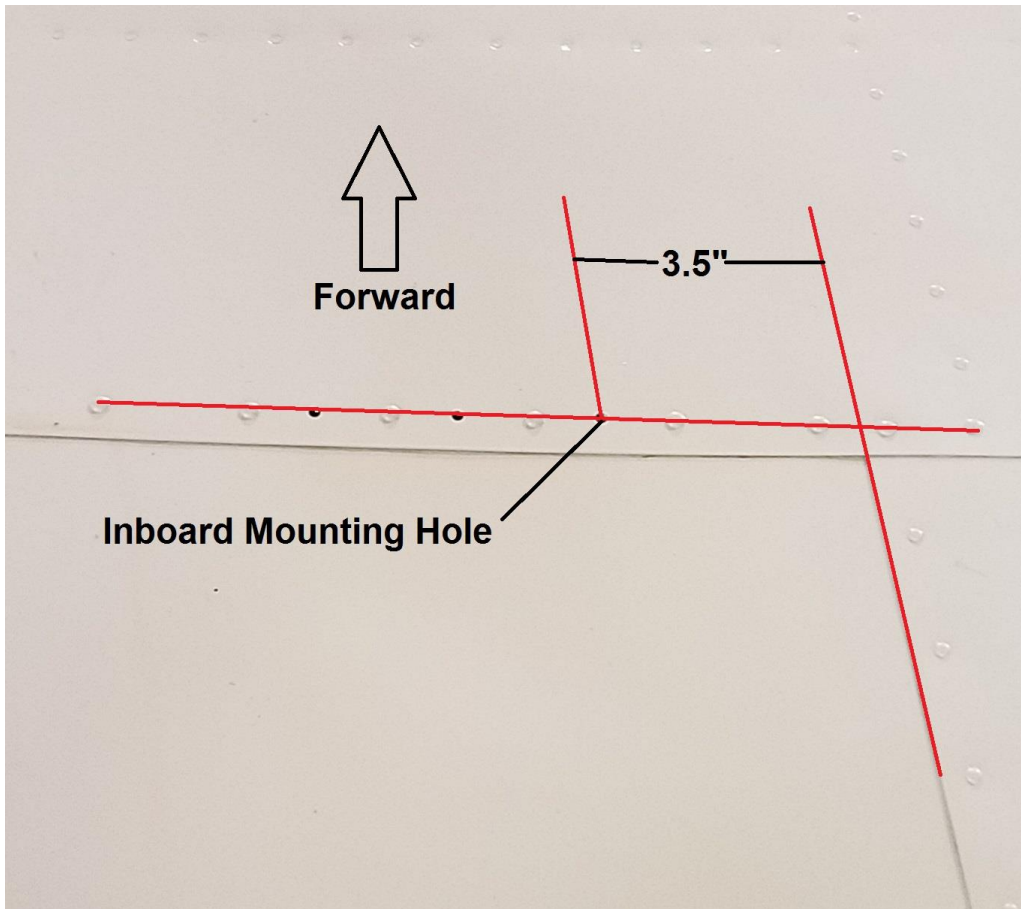

Figure 3-2

- 2.2. Drill the inboard hole only at this time with a #19 drill.
- 2.3. Invert the Cessna 18X Upper Roll Bracket (P/N 1450-127) on the upper wing skin and cleco the inner hole on the bracket to the hole drilled in the previous step. Rotate the bracket so that the middle and outer bracket mounting holes are aligned with the row of rivets in the rear wing spar as shown in Figure 3-3.

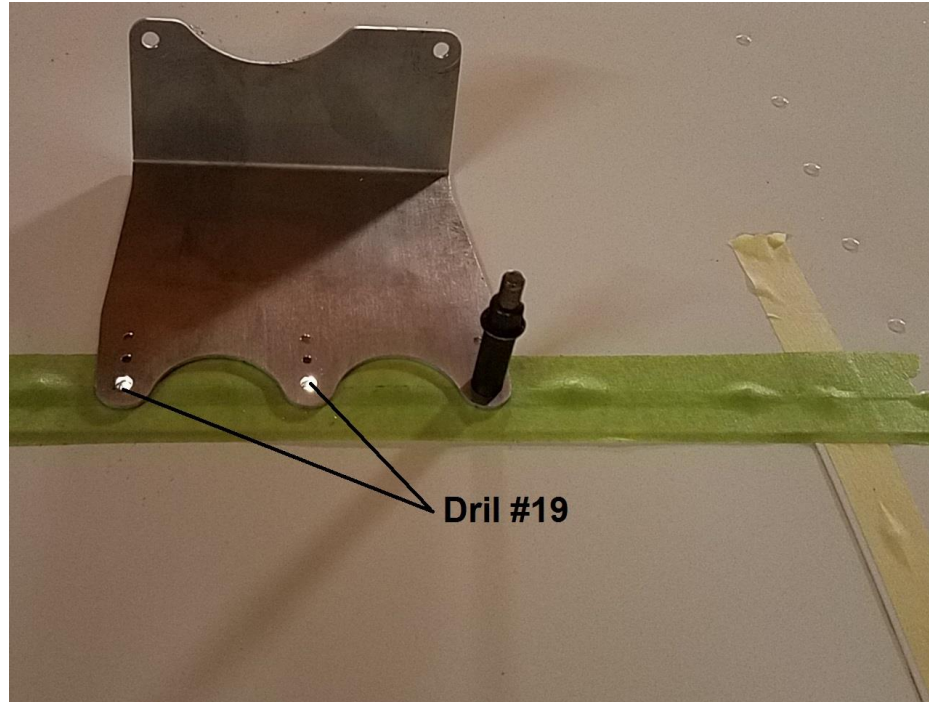

Figure 3-3

- 2.4. Match drill 2 holes as shown in Figure 3-3.
- 2.5. Remove the Cessna 18X Upper Roll Bracket (P/N 1450-127) from the wing and deburr the mounting holes that were drilled.
- 2.6. Temporarily attach the Cessna 18X Upper Roll Bracket (P/N 1450-127) to the Servo Bolt Pattern Plate (P/N 1420-216) using 2 ea. AN3-3A as shown in Figure 3-4.



Figure 3-4

- 2.7. Place the assembly shown in Figure 3-4 in the wing and cleco in place as shown in Figure 3-5.



Figure 3-5

2.8. Temporarily attach the Cessna 18X Lower Roll Bracket (1450-128) to the Servo Bolt Pattern Plate (P/N 1420-216) using 2 ea. AN3-3A as shown in Figure 3-6.



Figure 3-6

- 2.9. Drill Cessna 18X Lower Roll Bracket (1450-128) mounting holes.
 - 2.9.1. Align the lower bracket mounting holes with row of rivets on the lower spar flange.
 - 2.9.2. Match drill the outboard mounting hole using a #19 bit from inside the wing.
 - 2.9.3. Secure the outboard hole with a cleco.
 - 2.9.4. Match drill the remaining 2 holes on the Cessna 18X Lower Roll Bracket (1450-128) installing a cleco after each hole is drilled.
 - 2.9.5. Remove all components from the wing and debur the lower mounting holes.
 - 2.9.6. Remove the Servo Bolt Pattern Plate (P/N 1420-216) from the Cessna 18X Upper Roll Bracket (P/N 1450-127).
- 2.10. Install anchor nuts in the Cessna 18X Upper Roll Bracket (P/N 1450-127) and Drill Cessna 18X Lower Roll Bracket (1450-128). Rivet 3 ea. MS21051-08 anchor nuts in place using 6 ea. MS20426AD3-4 rivets on each bracket.
- 2.11. Attach the appropriate roll servo arm to a 60 inch/lb PMA servo (P/N 8100-064 for 12 volt or P/N 8100-065 for 24 volt) using the provided 8-32 x 3/8" flat head screws. Use blue threadlocker (Loctite 242 or equivalent) and torque the screws to 18-20 in-lb.

Aircraft model	Roll Servo Arm
182E-182M	Cessna 172 Roll Servo Arm (P/N 7200-091)
182P-182T, R182, TR182	1.5" PMA Servo Arm (P/N 1420-209)

- 2.12. Allow a sufficient service loop and trim the roll servo wiring harness to length.
- 2.13. Terminate the roll servo wiring harness per the Vizion wiring diagram in the Vizion PMA Installation Guide (TruTrak Doc. 166) and install the 9 Pin Connector Backshell (2100-010).
- 2.14. Place the Cessna 18X Upper Roll Bracket (P/N 1450-127) and Cessna 18X Lower Roll Bracket (1450-128) in the wing in approximately the final mounting position but do not secure them to the wing.
- 2.15. Connect the roll servo wiring harness connector to the roll servo.
- 2.16. Place the roll servo assembly in the wing and loosely attach it to the Cessna 18X Upper Roll Bracket (P/N 1450-127) and Cessna 18X Lower Roll Bracket (1450-128) using 4 ea. AN3-3A bolts with MS35333-39 lock washers and blue threadlocker (Loctite242 or equivalent). The next steps must be performed quickly so that the threadlocker does not begin to cure prior to final torqueing. The roll servo arm should be oriented upward between the servo stops.
- 2.17. Align the Cessna 18X Upper Roll Bracket (P/N 1450-127) with the holes in the upper spar and start 3 ea. AN526C-832R8 screws in the associated anchor nuts.
- 2.18. Align the Cessna 18X Lower Roll Bracket (1450-128) with the holes in the upper spar and start 3 ea. AN526C-832R8 screws in the associated anchor nuts.
- 2.19. Fully tighten the upper and lower AN526C-832R8 mounting screws.
- 2.20. Torque the 4 AN3-3A servo mounting bolts to 20-25 in-lb.
- 2.21. Remove the inspecting cover near the left aileron bellcrank.
- 2.22. Loosen one of the aileron cable turnbuckles to allow for easy removal and replacement of the bolt connecting the aileron cable to the bellcrank.

2.23. Remove the rear aileron cable bolt from the left aileron bellcrank and replace with hardware as shown in Figure 3-7

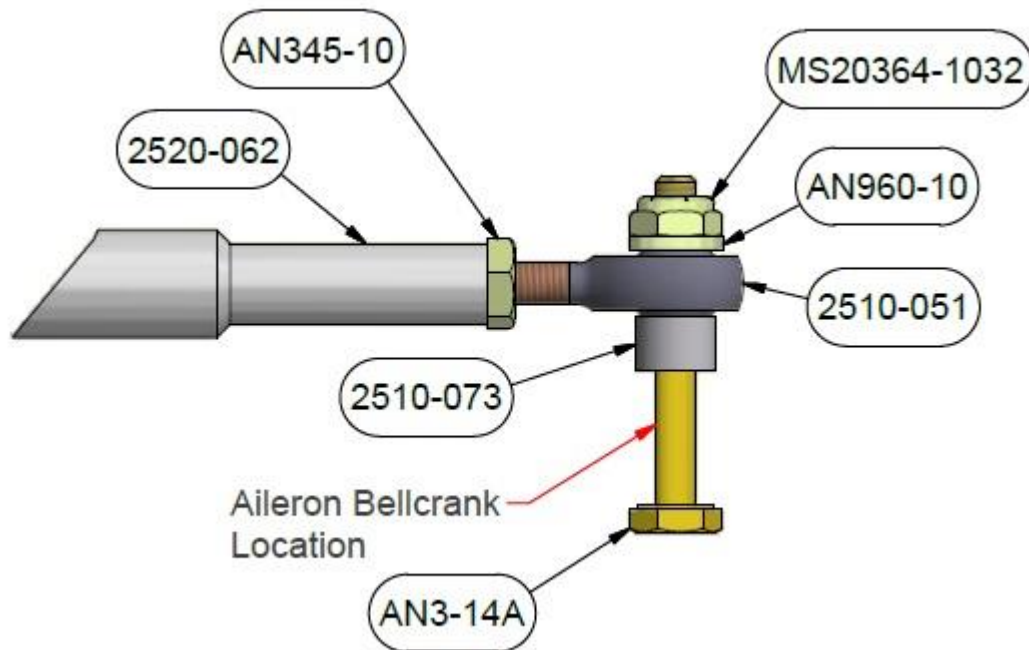

for 182E-182N or in Figure 3-8 for 182P-182T, R182 or TR182. Torque the AN-3 bolt to 20-25 in-lb.

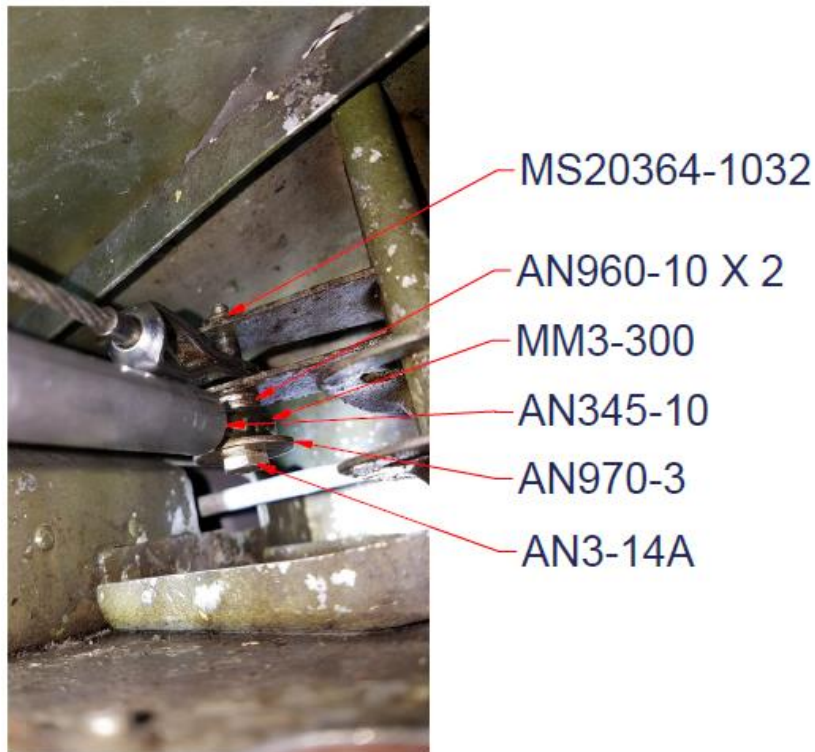

Figure 3-7

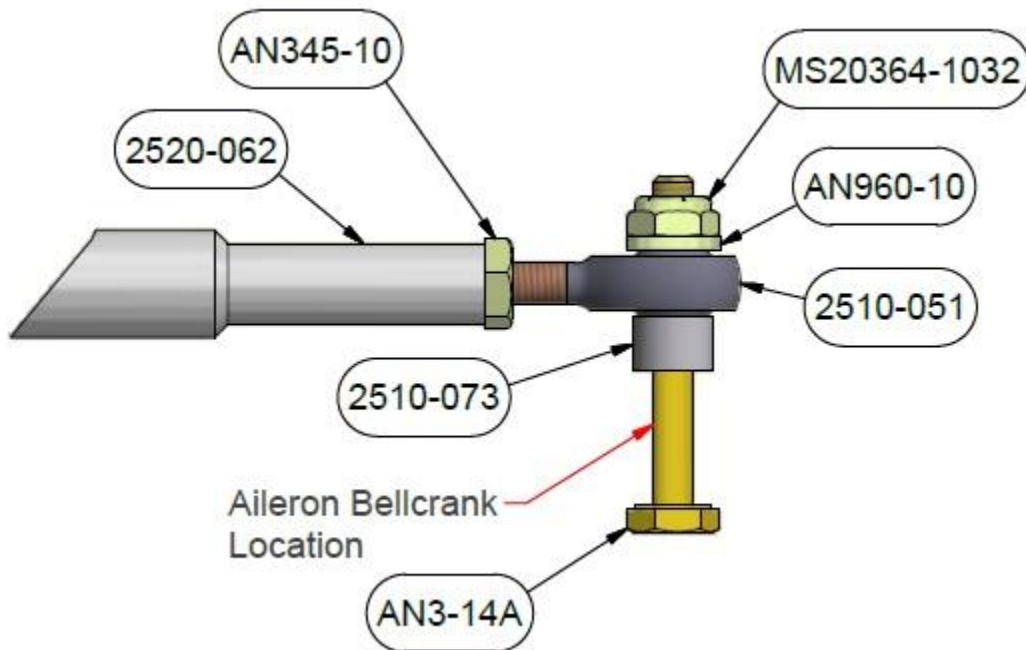

Figure 3-8

2.24. Tension the aileron cable according to the aircraft service manual.
NOTE: Proper cable tension is essential for proper autopilot performance! Use a tensiometer to verify cable tension.

- 2.25. Verify that aileron rigging is correct according to the aircraft service manual and adjust as needed.
- 2.26. Safety wire the aileron cable turnbuckle.
- 2.27. Fully thread an AN345-10 on a MM3-300 rod end bearing then partially thread the MM3-300 rod end bearing in one end of the 41" push rod (2520-062).
- 2.28. Insert the push rod assembly in the aileron bellcrank inspection hole with the rod end bearing going toward the roll servo.
- 2.29. Ensure that the aileron cable is not wrapped around the 41" push rod (2510-062) then partially thread the MM3-300 rod end attached to the aileron bellcrank in the outboard end of the push rod.
- 2.30. Have an assistant hold the yoke in the full right position and rotate the servo arm against the outboard stop on the roll servo bracket.
- 2.31. Thread the MM-3-300 rod end bearing into the servo end of the pushrod until the pushrod is the correct length to align with the drive point on the servo arm.
- 2.32. Verify that the control cable is not twisted around the pushrod.
- 2.33. Attach the pushrod assembly to the roll servo arm as shown in Figure 3-9 for 182E-182N or in Figure 3-10 for 182P-182T, R182 or TR182 and torque to 20-25 in-lb.

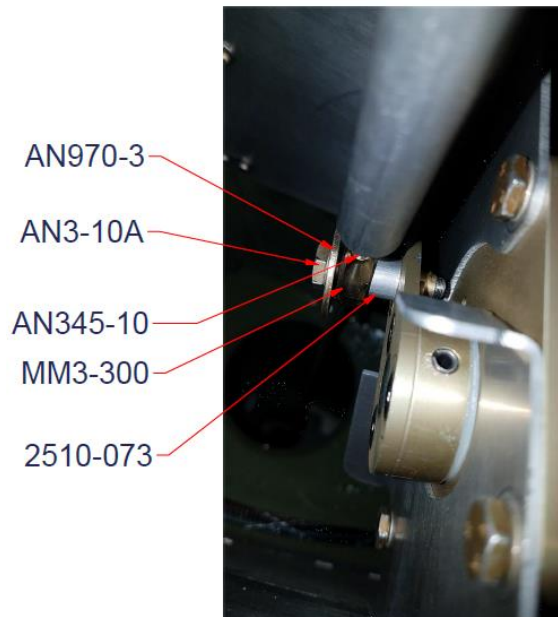

Figure 3-9

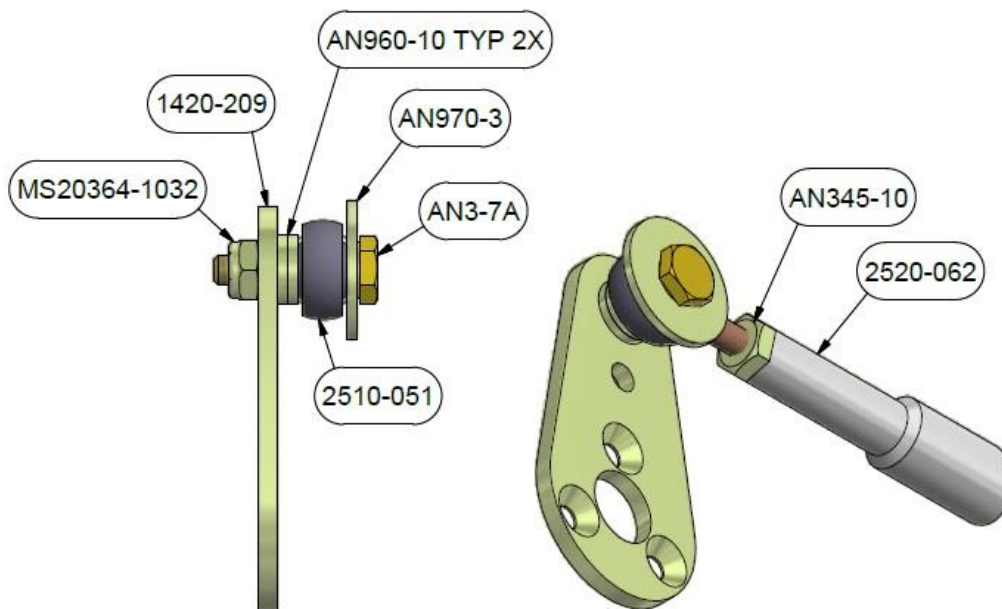

Figure 3-10

- 2.34. Apply blue threadlocker (Loctite242 or equivalent) to the threaded shank of both MM3-300 rod ends. Rotate the pushrod until the rod end bearings on each end are threaded in equally then tighten the jam nuts to 20-25 in-lb.
- 2.35. Move the yoke throughout the full range of travel and check for binding in the rod end bearings. If binding exists adjust the rod end bearings and jam nuts to eliminate it.
- 2.36. **Ensure that aircraft stops are contacted prior to servo stops. Adjust length of pushrod as needed until servo stops are not contacted when controls are moved to both ends of travel.**



- 2.37. Verify that the servo and pushrod motion are unobstructed throughout the full control travel. Once wiring harness is installed, ensure that the wiring harness is properly secured to prevent interference.
- 2.38. **Apply torque seal to all bolts after final torquing is achieved.**

3.3. Pitch Servo Materials List

QTY	PART NUMBER	DESCRIPTION
1	8100-064 (12 Volt) OR 8100-065 (24 Volt)	60 in-lb PMA Servo
1	7200-111	Late Model 182 Pitch Push Rod
1	7200-110	Late Model 182 Pitch Tray Assembly
1	7200-106	2.75" PMA Servo Arm Assembly
1	6000-064	Sheathed Microfit 6 Pos Cable Asm 1M
1	2510-081	MM-4 Rod End Bearing
1	2510-051	Small Rod End Bearing MM-3-300
3	2500-216	8-32 x 3/8 Flat Head Socket Cap Screw SS
3	2500-208	AN90-416
1	2500-205	AN970-4 Washer
1	2500-138	AN4-15A Bolt
10	2500-121	MS20365-832 8-32 Fiberlock Nut
1	2500-113	MS20365-428 1/4-28 Fiberlock Nut
4	2500-081	MS35333-39 Internal Lock Washer
2	2500-076	AN960-10
10	2500-075	AN3-3A Bolt
10	2500-069	8-32 X 5/8 Screw AN526C832R10
1	2500-068	AN3-7A Bolt
1	2500-055	AN345-10
1	2500-054	AN315-4
1	2500-047	AN970-3 Washer
1	1450-130	Late 182 Pitch Bracket

3.4. Cessna 182E-182T Pitch Servo Mounting Instructions

1. The pitch servo will be mounted in the aft fuselage as shown in Figure 3-11.

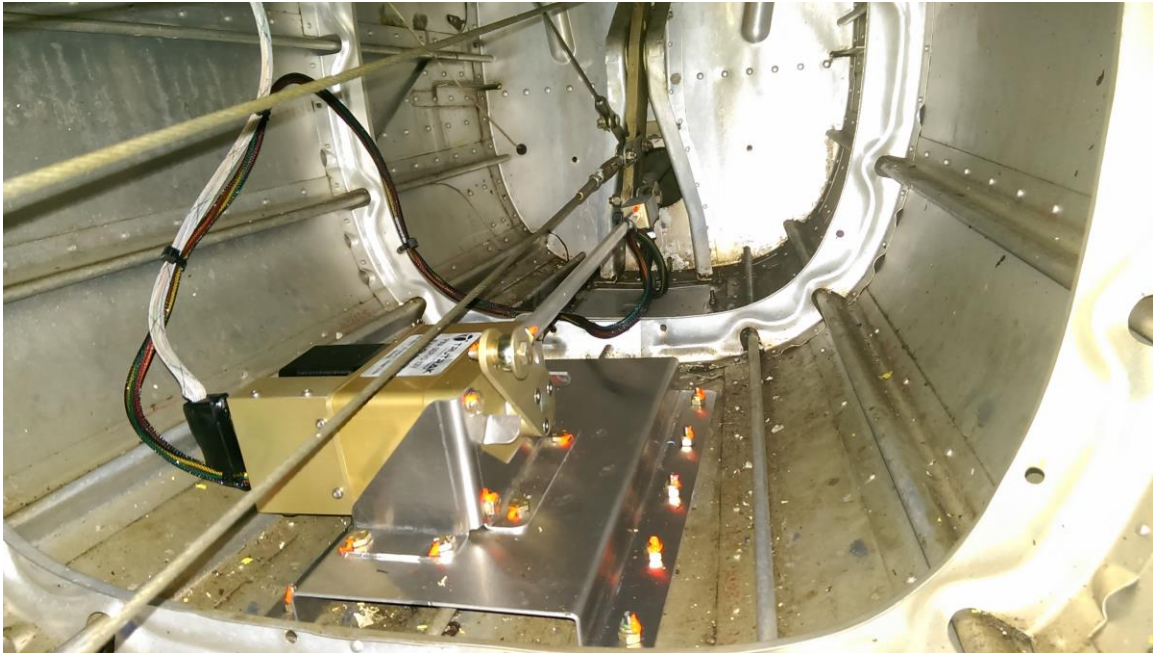

Figure 3-11

2. Remove the baggage compartment bulkhead to access the rear fuselage.
3. Remove the rear inspection cover on the bottom of the fuselage.
4. Rotate the Late 182 Pitch Tray Assembly (7200-110) so that the bolt pattern for the Late 182 Pitch Bracket (1450-130) is to the front right of the aircraft. Place the forward edge of the Late 182 Pitch Tray Assembly (7200-110) 1" aft of station 185.50" and centered laterally on the lower skin inside the aft fuselage. The elevator cables provide a good reference of the centerline of the aircraft.
5. Using a #19 bit match drill the lower fuselage skin to the 10 holes on the lower flanges of the Late 182 Pitch Tray Assembly (7200-110). After drilling each hole secure the tray to the fuselage using a cleco.
6. Remove the tray from the aircraft and deburr the mounting holes.
7. Attach the Late 182 Pitch Bracket (1450-130) to the Late 182 Pitch Tray Assembly (7200-110) using 6 ea. AN3-3A bolts. Torque to 20-25 in-lb.
8. Attach the Late 182 Pitch Tray Assembly (7200-110) to the lower fuselage skin using 10 ea. AN526C-832R8 screws and 10 ea. MS20365-832 nuts.
9. Attach the 2.75" PMA Servo Arm Assembly (P/N 7200-106) to the 60 inch/lb PMA servo (P/N 8100-064 for 12 volt or P/N 8100-065 for 24 volt) using the provided 8-32 x 3/8" flat head screws. Use blue threadlocker (Loctite 242 or equivalent) and torque the screws to 18-20 in-lb.

10. Remove the 2 jack screws from a 60 in/lb PMA servo (P/N 8100-064 for 12 volt or P/N 8100-065 for 24 volt) and install 2 of the hex head slide lock jack screws included in the wiring harness kit. Use blue threadlocker (Loctite 242 or equivalent) and torque the screws to 2-3 in-lb.



Figure 3-12



Figure 3-13



Figure 3-14

11. Attach the pitch servo assembly to the Late 182 Pitch Bracket (1450-130) using 4 ea. AN3-3A bolts with MS35333-39 lock washers and blue threadlocker (Loctite242 or equivalent). Torque to 20-25 in-lb. Ensure that the 2.75" PMA Servo Arm Assembly (P/N 7200-106) is orientated upward between the servo stops.
12. Remove the AN4 bolt securing the elevator push rod to the bottom of the elevator bellcrank and replace with hardware as shown in Figure 3-15.

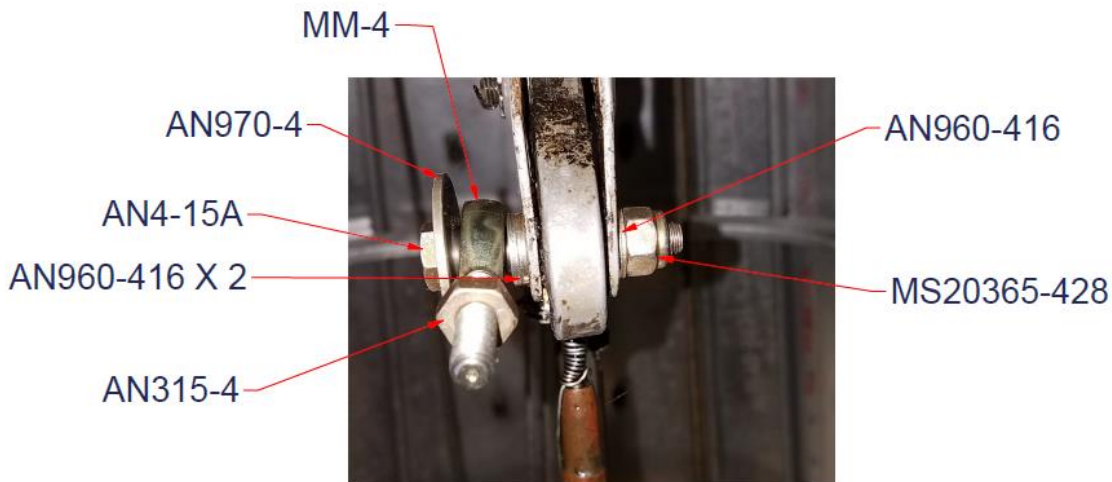

Figure 3-15

13. Partially thread the link sensor end of the Late 182 Pitch Push Rod (7200-111) in the MM-4 rod end attached to the elevator bellcrank.
14. Fully thread an AN345-10 nut on a MM3-300 rod end then partially thread the MM3-300 rod end into the forward end of the Late 182 Pitch Push Rod (7200-111).
15. Have an assistant hold the yoke in the full aft position and rotate the servo arm against the aft stop on the pitch servo bracket.
16. Thread the MM-3-300 rod end bearing into the servo end of the pushrod until the pushrod is the correct length to align with the drive point on the servo arm.
17. Attach the pushrod to the pitch servo arm with hardware as shown in Figure 3-16 and torque to 20-25 in-lb.

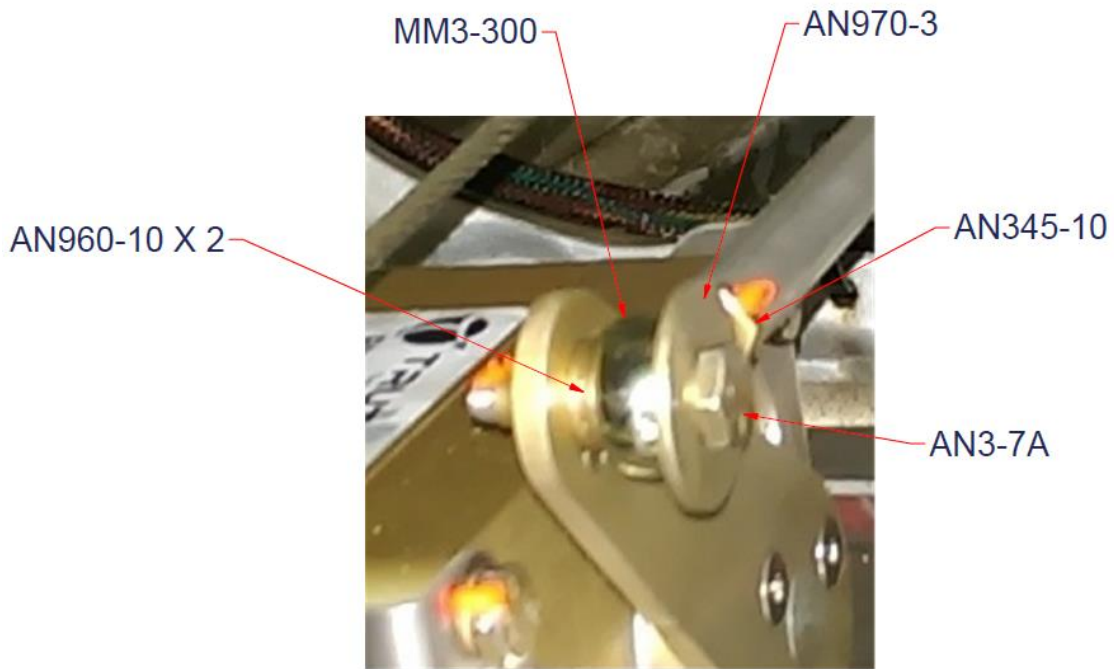

Figure 3-16

18. Apply blue threadlocker (Loctite242 or equivalent) to the threaded shank of both rod ends. Rotate the pushrod until the rod end bearings on each end are threaded in equally and the link sensor connector is pointed directly down then tighten the jam nuts to 20-25 in-lb.
19. Move the yoke throughout the full range of travel and check for binding in the rod end bearings. If binding exists adjust the rod end bearings and jam nuts to eliminate it.
20. **Ensure that aircraft stops are contacted prior to servo stops. Adjust length of pushrod as needed until servo stops are not contacted when controls are moved to both ends of travel.**
21. Complete routing of the pitch servo wiring harness and trim to length.
22. Terminate the pitch servo wiring harness per the Vizion wiring diagram **USING OPTION B** in the Vizion PMA Installation Guide (TruTrak Doc. 166) using a Right Angle D-sub 9 Pin Backshell Kit (P/N 8210-011).
23. The pitch servo connector backshell and slidelock should be assembled as shown in Figure 3-17.

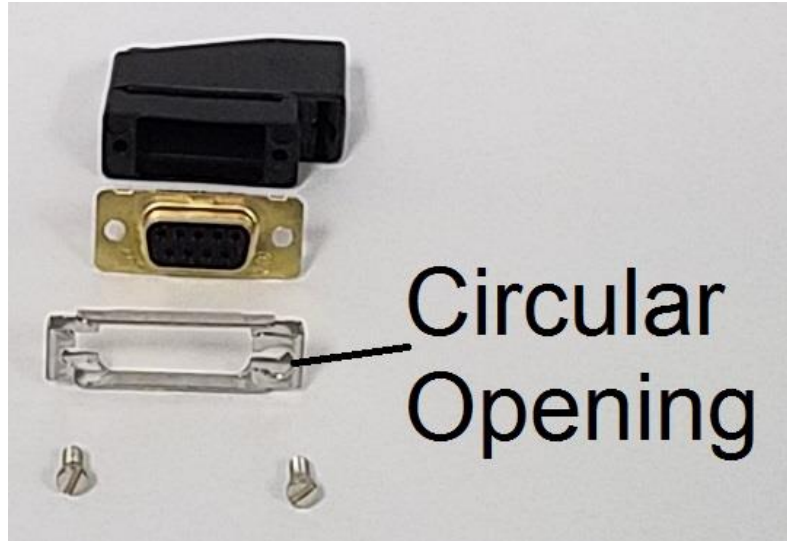

Figure 3-17

24. Insert and tighten the cable retention clamp on the servo connector backshell as seen in Figure 3-18.



Figure 3-18

25. Connect the pitch servo connector.
26. Connect the Sheathed Microfit Cable Assembly 1M (P/N 6000-064) to the PMA link sensor (P/N 8000-177) and pitch servo (P/N 8100-064 for 12 volt or P/N 8100-065 for 24 volt).
27. Secure the Sheathed Microfit Cable Assembly 1M (P/N 6000-064) so that routing is as shown in Figure 3-19. Ensure that cable is free to move as the link sensor moves through full control deflection without excess pressure on the connector.

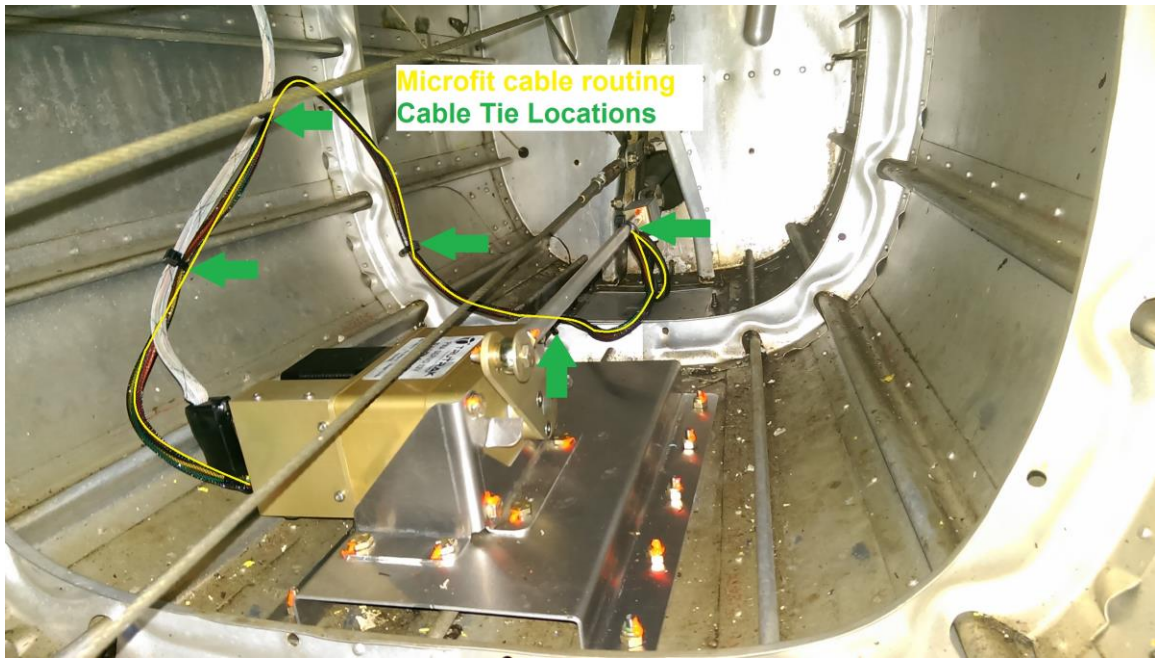
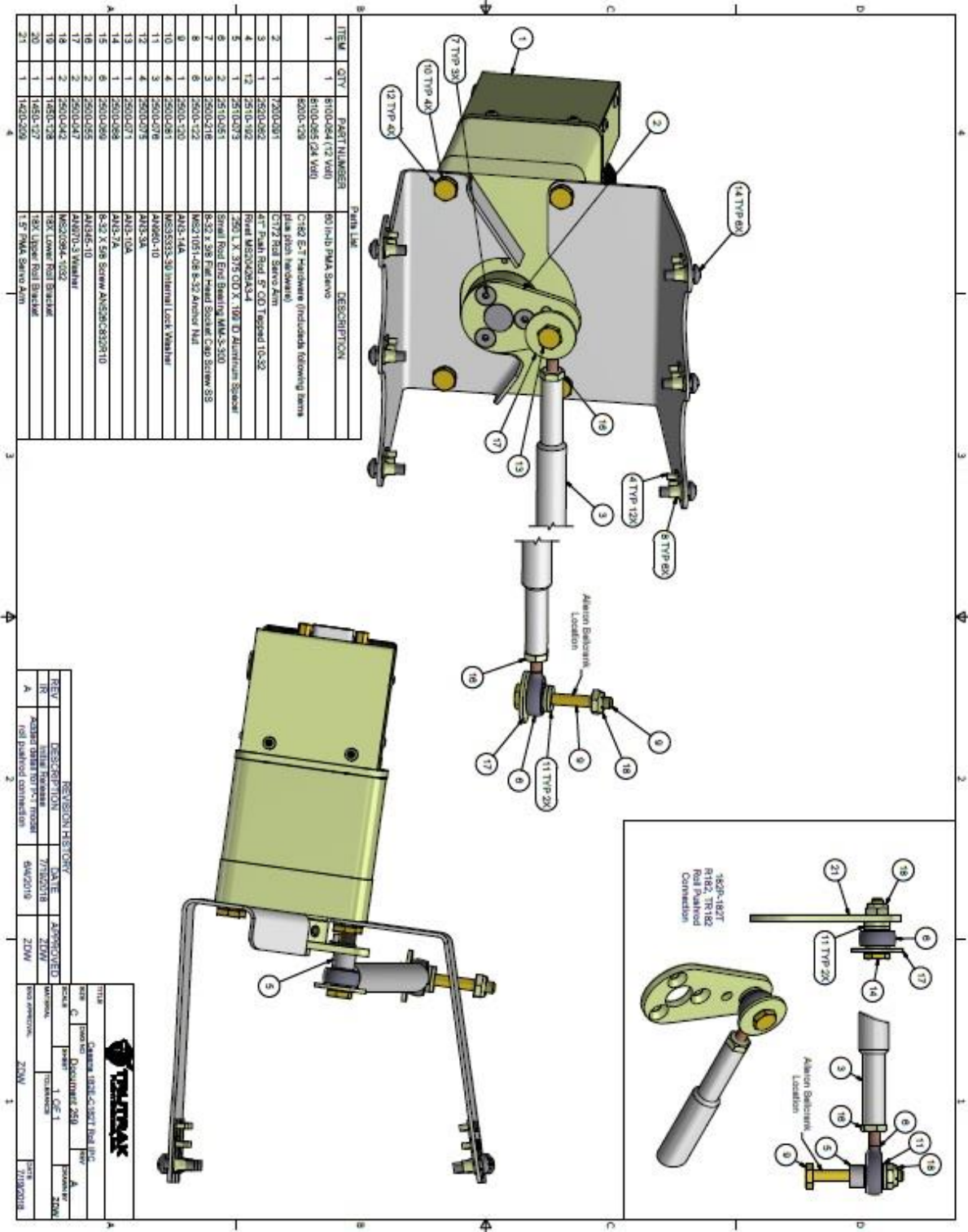

Figure 3-19

28. Verify that the servo and pushrod motion are unobstructed throughout the full control travel.
29. Replace all inspection covers, carpet, seats, and interior previously removed during the installation.
30. Reconnect the aircraft battery.

3.5. Cessna 182E-182T Vizion Roll IPC



3.6. Cessna 182E-182T Vizion Pitch IPC

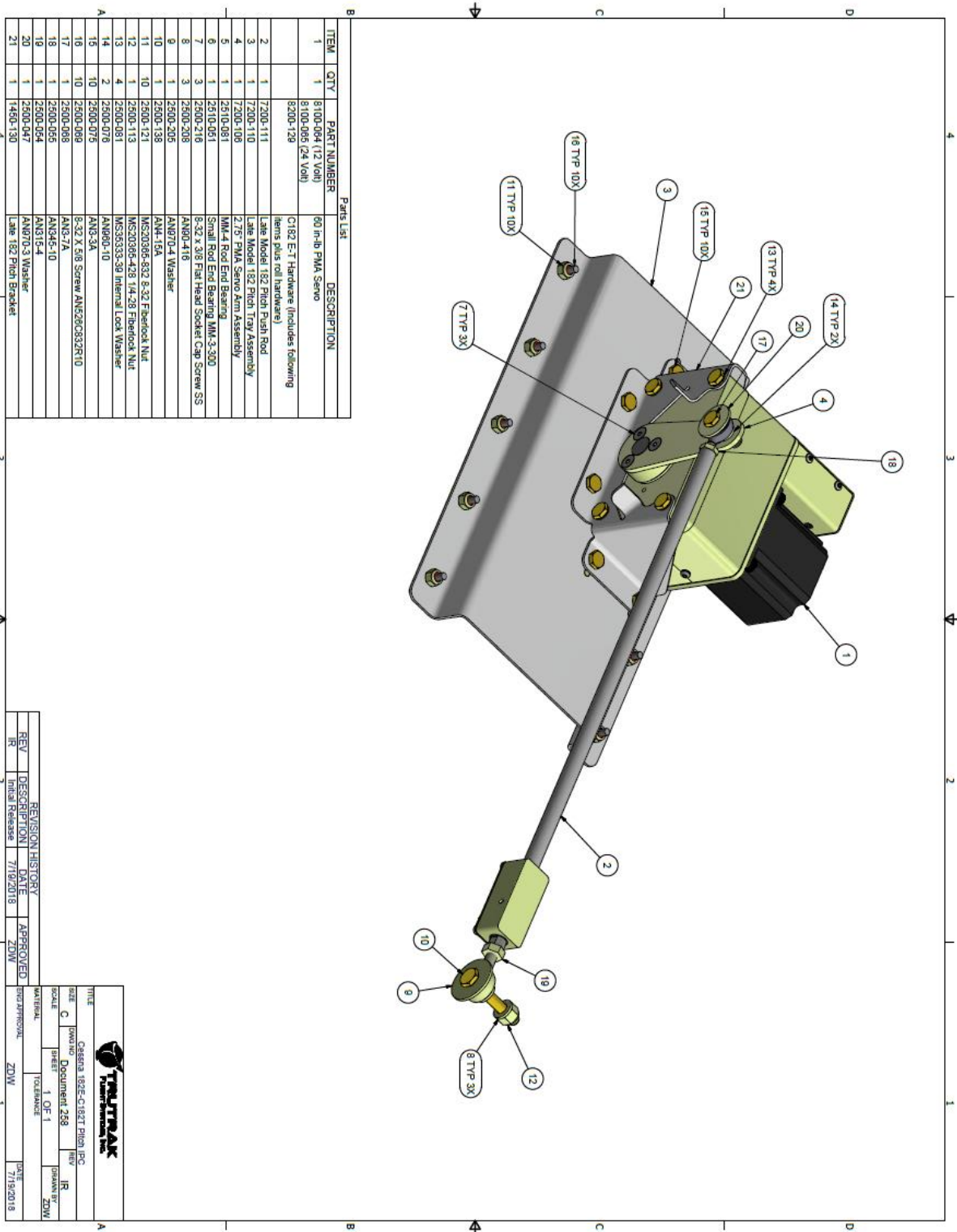

4. Cessna 182E-182T Autopilot Settings

Once all wiring is complete, verified, and the GPS setup has been completed (Vizion PMA Installation Guide (TruTrak Doc. 166)), follow the steps below to verify proper autopilot settings.

THIS STEP MUST BE COMPLETED PRIOR TO GROUND CHECK AND FLIGHT CHECK!!!

4.1. Lateral Autopilot Settings

For Vizion software version PV.30 follow the steps below:

- 1) *PRESS and HOLD* KNOB
- 2) Apply power to autopilot and GPS
- 3) *RELEASE* KNOB.
- 4) *PRESS* KNOB to advance to MIN BACKLIGHT
- 5) *PRESS* KNOB to advance to SETUP ENABLE.
- 6) *ROTATE* KNOB to select a value of **10**.
- 7) *PRESS* KNOB to exit.
- 8) *PRESS and HOLD* MODE button until LAT ACTIVITY is shown.
- 9) *ROTATE* KNOB to select a LAT ACTIVITY of **17**
- 10) *PRESS* ALT button to advance to next setup screen.
- 11) *ROTATE* KNOB to select a BAUD that matches the baud rate of the GPS (this will be either **4800** or **9600**, refer to Approved GPS List (Doc 186) for information about approved GPS units).
- 12) *PRESS* ALT button to advance to next setup screen.
- 13) *ROTATE* KNOB to select a BANK ANGLE of **MED**.
- 14) *PRESS* ALT button to advance to next setup screen.
- 15) *ROTATE* KNOB to select a MICROACTIVITY of **10**.
- 16) *PRESS* ALT button to advance to next setup screen.
- 17) *ROTATE* KNOB to select a GPSS GAIN of **16**.
- 18) *PRESS* ALT button to advance to next setup screen.
- 19) *ROTATE* KNOB to set ROLL REV to **Y**.
- 20) *PRESS* KNOB to exit lateral setup and return to the home screen.
- 21) *PRESS and HOLD* ALT button until VRT ACTIVITY is shown.
- 22) *WHILE CONTINUING TO HOLD* ALT, *PRESS* MODE.
- 23) *RELEASE* MODE and ALT.
- 24) *PRESS* MODE until MAC is displayed.
- 25) *ROTATE* KNOB to set MAC to **2**.
- 26) *PRESS* KNOB to exit menu and return to home screen.
- 27) Do not remove power from autopilot.

For Vizion software version PV.40 follow the steps below:

- 1) *PRESS and HOLD* KNOB
- 2) Apply power to autopilot and GPS

- 3) *RELEASE* KNOB.
- 4) *PRESS ALT* button to advance to MIN BACKLIGHT
- 5) *PRESS ALT* button to advance to SETUP ENABLE.
- 6) *ROTATE* KNOB to select a value of **10**.
- 7) *PRESS ALT* button to exit.
- 8) *PRESS and HOLD* MODE button until LAT ACTIVITY is shown.
- 9) *ROTATE* KNOB to select a LAT ACTIVITY of **17**
- 10) *PRESS ALT* button to advance to next setup screen.
- 11) *ROTATE* KNOB to select a BAUD that matches the baud rate of the GPS (this will be either **4800** or **9600**, refer to Approved GPS List (Doc 186) for information about approved GPS units).
- 12) *PRESS ALT* button to advance to next setup screen.
- 13) *ROTATE* KNOB to select a BANK ANGLE of **MED**.
- 14) *PRESS ALT* button to advance to next setup screen.
- 15) *ROTATE* KNOB to select a MICROACTIVITY of **10**.
- 16) *PRESS ALT* button to advance to next setup screen.
- 17) *ROTATE* KNOB to select a GPSS GAIN of **16**.
- 18) *PRESS ALT* button to advance to next setup screen.
- 19) *ROTATE* KNOB to set ROLL REV to **Y**.
- 20) *PRESS* KNOB to exit lateral setup and return to the home screen.
- 21) *PRESS and HOLD* ALT button until VRT ACTIVITY is shown.
- 22) *WHILE CONTINUING TO HOLD* ALT, *PRESS* MODE.
- 23) *RELEASE* MODE and ALT.
- 24) *PRESS* MODE until MAC is displayed.
- 25) *ROTATE* KNOB to set MAC to **2**.
- 26) Repeatedly *PRESS ALT* button until EFIS TYPE is displayed
- 27) *ROTATE* KNOB to set EFIS TYPE to:
 - 1** – if the autopilot is connected to an ASPEN,
 - 2** – if the autopilot is connected to a G5,
 - 0** – if the autopilot is connected to any other GPS.
- 28) *PRESS* KNOB to exit menu and return to home screen.
- 29) Do not remove power from autopilot.

4.2. Vertical Autopilot Settings

For Vizion software version PV.30 follow the steps below:

- 1) *PRESS and HOLD* ALT button until VRT ACTIVITY is shown.
- 2) *ROTATE* KNOB to select a VRT ACTIVITY of **16**.
- 3) *PRESS ALT* button to advance to next setup screen.
- 4) *ROTATE* KNOB to select a MIN AIRSPD of (Refer to aircraft POH and set a value equal to **1.3 V_s** in knots).
- 5) *PRESS ALT* button to advance to next setup screen.
- 6) *ROTATE* KNOB to select a MAX AIRSPD of (Refer to aircraft POH and set a value equal to **0.9 V_{NE}** in knots).

- 7) *PRESS* ALT button to advance to next setup screen.
- 8) *ROTATE* KNOB to select a PITCH REV of **N**.
- 9) *PRESS* ALT button to advance to next setup screen.
- 10) *ROTATE* KNOB to select a STATIC LAG of **1**.
- 11) *PRESS* ALT button to advance to next setup screen.
- 12) *ROTATE* KNOB to select a MICROACTIVITY of **5**.
- 13) *PRESS* ALT button to advance to next setup screen.
- 14) *ROTATE* KNOB to select a HALF STEP of **N**.
- 15) *PRESS* KNOB to exit vertical setup and return to the home screen.
- 16) Cycle power on the autopilot.

For Vizion software version PV.40 follow the steps below:

- 1) *PRESS and HOLD* ALT button until VRT ACTIVITY is shown.
- 2) *ROTATE* KNOB to select a VRT ACTIVITY of **16**.
- 3) *PRESS* ALT button to advance to next setup screen.
- 4) *ROTATE* KNOB to select a MIN AIRSPD of (Refer to aircraft POH and set a value equal to **1.3 V_s** in knots).
- 5) *PRESS* ALT button to advance to next setup screen.
- 6) *ROTATE* KNOB to select a MAX AIRSPD of (Refer to aircraft POH and set a value equal to **0.9 V_{NE}** in knots).
- 7) *PRESS* ALT button to advance to next setup screen.
- 8) *ROTATE* KNOB to select a PITCH REV of **N**.
- 9) *PRESS* ALT button to advance to next setup screen.
- 10) *ROTATE* KNOB to select a STATIC LAG of **1**.
- 11) *PRESS* ALT button to advance to next setup screen.
- 12) *ROTATE* KNOB to select a MICROACTIVITY of **5**.
- 13) *PRESS* ALT button to advance to next setup screen.
- 14) *ROTATE* KNOB to select desired DEFAULT VS (this is the vertical speed setting that the autopilot will use as the value to determine whether or not to synchronize to current vertical speed or synchronize to zero vertical speed, as well as the default vertical speed for altitude pre-select). For example, if the DEFAULT VS is set to 300 fpm, if the aircraft is climbing at 200 fpm, the autopilot select zero VS upon engagement. If the aircraft is climbing at 400 fpm, the autopilot will select 400 fpm upon engagement.
We suggest using 300-400 feet per minute.
- CAUTION!** Do not select a DEFAULT VS that is too high, or autopilot performance may be adversely affected.
- 15) *PRESS* KNOB to exit vertical setup and return to the home screen.
- 16) Cycle power on the autopilot.



TruTrak Flight Systems, Inc.